

electrophoresis | radiation safety | laboratory accessories



 **SCIE-PLAS**
product catalogue



Welcome to the latest Scie-Plas product catalogue

This freshly revised product catalogue includes the very latest systems for electrophoresis applications. Scie-Plas is proud to be specialists in the field of electrophoresis instrumentation and we believe that our application focused instruments, our dedicated team of fabrication specialists, and qualified support team offer our customers a level of service second to none.

This catalogue demonstrates a real depth of product range that covers all aspects of electrophoresis applications. Our team is constantly investigating new ways to improve our existing products as well as looking for new areas of research where our products will be of relevance and significant benefit.

Scie-Plas Ltd operates in a global market and is recognised worldwide as a leader and innovator in electrophoresis and associated techniques. Working closely with our experienced network of dealers around the globe, Scie-Plas products can be found in most leading universities, hospitals and research facilities.

In order to satisfy an ever growing global biotech market, Scie-Plas Ltd recently relocated its manufacturing to a state-of-the-art facility in San Francisco, CA. Our sales, order entry and accounts team remain in the UK, but have relocated to a dedicated facility that provides access to the space that a growing company requires. However, we will still maintain products in Europe to facilitate rapid order fulfilment for our customers. We believe that these recent endeavours will enable Scie-Plas to respond rapidly to our customer enquiries and ensure that our valued customers receive not only the very best product, but also the very best customer service.

We would like to thank all of our customers and distribution partners for their continued support, and we trust that Scie-Plas will remain your first choice for all of your electrophoresis requirements.

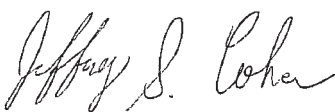

Jeffrey Cohen
Division President

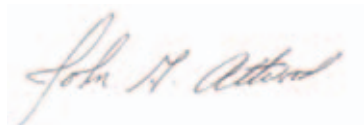

John Attwood
Division Sales & Marketing Director

Introduction	i		
Horizontal Gel Units	1-34		
HB-SET Mini-gel	4		
Easigel H1-SET	5		
HU6 Mini Horizontal	6		
HU10 Mini-Plus Horizontal	8		
HU13 Midi Horizontal	10		
HU15 Standard Horizontal	12		
HU20 Maxi-Standard Horizontal	14		
HU25 Maxi-Plus Standard Horizontal	16		
CHU20 Maxi-Cooled Horizontal	18		
CHU25 Maxi-Plus Cooled Horizontal	20		
SVG-SYS Vari-gel Mini System	24		
TVG-SYS Vari-gel Midi System	26		
VG-SYS Vari-gel Maxi System	28		
VG-FAST96 High Throughput Vari-gel Maxi System	30		
Horizontal Gel Casting Products	32		
Scie-Plas Super-Seals™	33		
Accessories & Buffer Recirculation Pump	34		
Specialist Gel Units	36-40		
CA-SYS Cellulose Acetate System	36		
COMET Single Cell Gel Electrophoresis Systems	38		
The IEF-SYS Dedicated Isoelectric Focusing Unit	40		
Vertical Gel Units	43-70		
The TV50 Single-Plate Mini-Gel Electrophoresis Unit	36		
TV100 Twin-Plate Mini-Gel Electrophoresis Units	38		
TV200 Twin-Plate Wide Format Mini-Gel Electrophoresis Units	52		
TV400 Twin-Plate Maxi-Gel Electrophoresis Units	56		
TV Complete Modular Systems	60		
TV Modular Electroblotting Systems	62		
TV Modular 2-D Systems	64		
The TV100YK and TV400YK-2D-IEF-SYS Units: Dedicated 2-D Electrophoresis Systems	67		
The TVS1400 Single-Plate Large Format Vertical Gel Electrophoresis Unit	70		
Gel Drying Systems	73-75		
The GD-4534 and GD-5040 Gel Dryers	73		
The Vacuubrand® MZ 2C + 2 AK Vacuum Pump	75		
Gradient Gel Electrophoresis	76-80		
The TV400-DGGE Denaturing Gradient Gel Electrophoresis System	76		
Gradient Mixers	79		
TV100, TV200 and TV400 Gel Multicasters	80		
Gel Temperature Control	82		
Recirculating Cooler/Chiller	82		
Blotting Units			83-89
The TV100-EBK Mini and TV400-EBK Maxi Electroblotters			84
The V10-SDB and V20-SDB Semi-Dry Blotters			86
The CP-2826 Maxi Capillary Blotter			87
Dot and Slot Blot Microfiltration Manifolds			88
Power Supplies			90-92
Power Supply Accessories			90
Consort EV200 Range Power Supply Units			91
Electrodialysis			93-95
The ElectroPrep™			93
Gel Documentation			96-97
Scie-Plas VISION Gel Documentation System			96
GeneTools Software			97
PCR® Products			98-99
The GLE-UVSC UV Sterilisation Cabinet			98
Techné® TC-3000 Thermal Cycler			99
Transilluminators			100-101
Biostep Transilluminators			100
Radiation Protection			104-115
Shielding			106
Storage Boxes			109
Waste Bins			111
Boxes and Pipette Shields			112
Transport and Container Covers			113
Cabinet Workstation			114
Safety Bags			114
Safety Trays and Liners			115
Laboratory Equipment			116
Workstation Accessories			116
Racks			116
Reagents			117-125
Agarose Gel Reagents and Buffers			117
Polyacrylamide Gel Reagents and Buffers			118
Isoelectric Focusing: Ampholytes,			
Precast Gels and IPG Strips			121
Precast PAGE Gels			123
Blotting Buffers & Membranes			124
Terms and Conditions			126

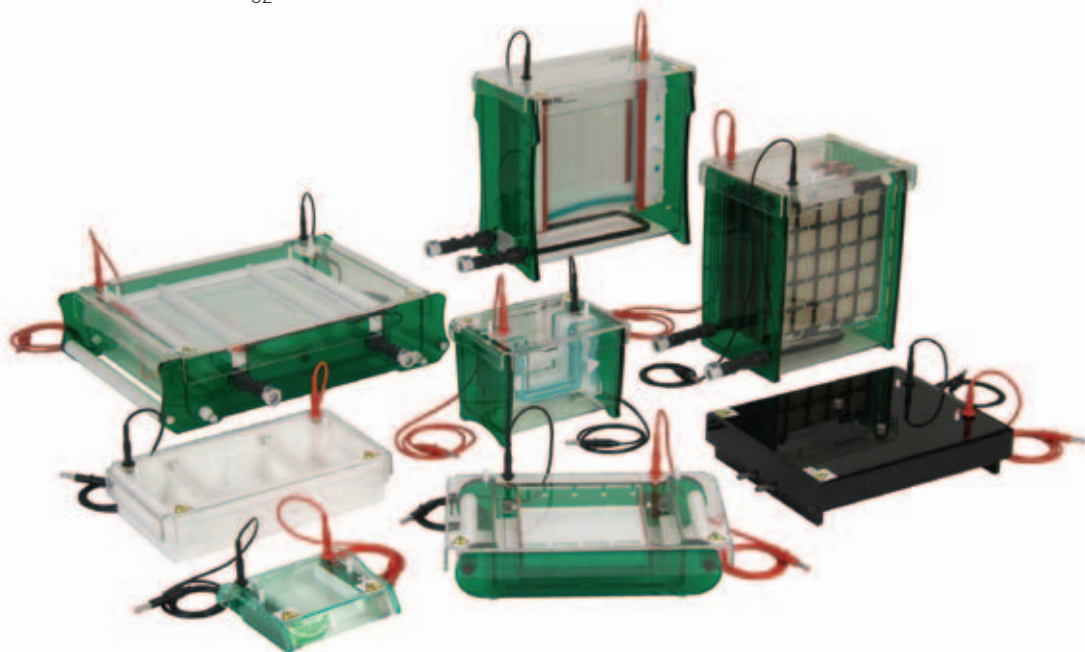

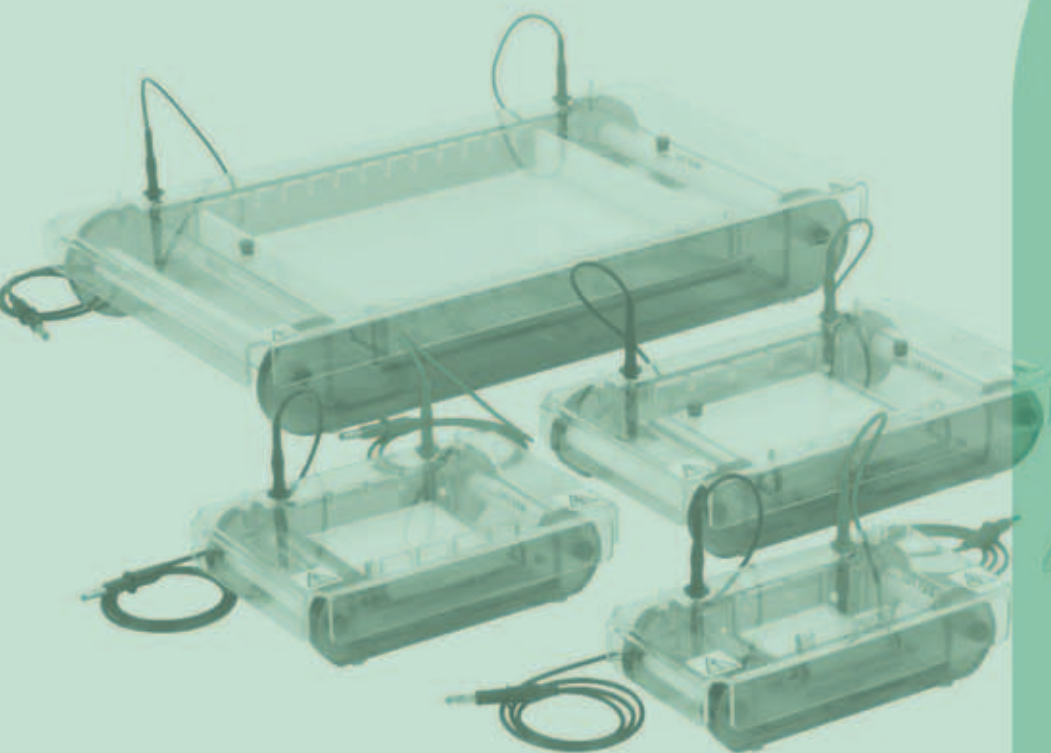

Horizontal Gel Units

Scie-Plas horizontal gel electrophoresis units offer the ultimate standards in innovative design and manufacture, acquired during our 20+ years existence.

Each model incorporates the many design and safety features recommended to us by scientists, either from within our in-house product development team or laboratories worldwide. As a result, all our models are manufactured and finished to the highest specification, easy to use, and, with safety always paramount, CE-marked - conforming to the latest European safety regulations.

BENEFITS INCLUDE

- Robust acrylic tank construction 12mm walls, leak proof
- Safety lid with integral power leads
- Shrouded 4mm power output connectors universally compatible with modern-day low to medium voltage power supplies
- Long-life, 99.99 % pure platinum electrodes
- Gold-plated terminals with corrosion-free stainless steel washers
- Durable high-impact polystyrene (HIPS) combs
- UV-transparent acrylic gel-casting trays
- Offset asymmetric electrodes
- Colour-coded combs corresponding to 1, 1.5 and 2mm thicknesses

Horizontal Gel Units

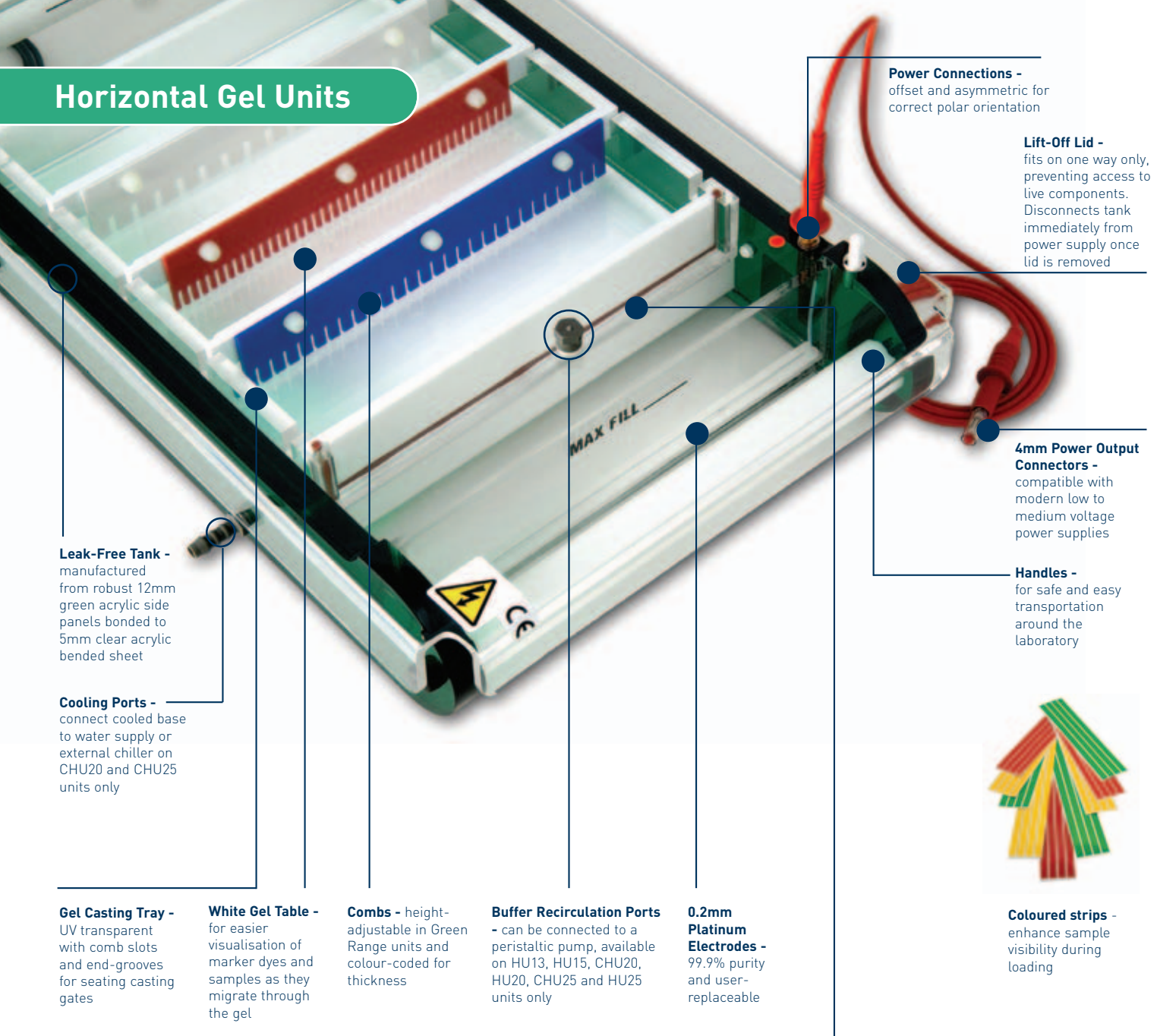

Power Connections -
offset and asymmetric for correct polar orientation

Lift-Off Lid -
fits on one way only, preventing access to live components. Disconnects tank immediately from power supply once lid is removed

4mm Power Output Connectors -
compatible with modern low to medium voltage supplies

Handles -
for safe and easy transportation around the laboratory

Leak-Free Tank -
manufactured from robust 12mm green acrylic side panels bonded to 5mm clear acrylic banded sheet

Cooling Ports -
connect cooled base to water supply or external chiller on CHU20 and CHU25 units only

Gel Casting Tray -
UV transparent with comb slots and end-grooves for seating casting gates

White Gel Table -
for easier visualisation of marker dyes and samples as they migrate through the gel

Combs - height-adjustable in Green Range units and colour-coded for thickness

Buffer Recirculation Ports - can be connected to a peristaltic pump, available on HU13, HU15, CHU20, HU20, CHU25 and HU25 units only

0.2mm Platinum Electrodes - 99.9% purity and user-replaceable



Coloured strips - enhance sample visibility during loading

Gel Casting Options - available in multiple internal and external formats



1. Plastic casting gates

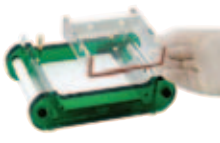

2. Silicone gaskets for direct in-tank casting



3. Silicone casting gates slot into preformed grooves



4. Casting gates with integral silicone seals

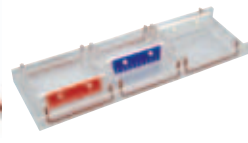

5. External casting unit for a maximum of 3 gels

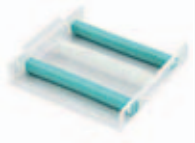

6. Super-Seals for flexible gel casting

CASTING OPTION AVAILABLE WITH THE GREEN RANGE HORIZONTALS

CASTING OPTION	HB-SET	H1-SET	HU6	HU10	HU13	HU15	HU20	CHU20	HU25	CHU25
1. Plastic casting gates	✓	✓								
2. Silicone gaskets			✓	✓	✓					
3. Silicone casting gates			✓	✓	✓					
4. Casting gates with integral silicone seals						✓	✓	✓	✓	✓
5. External casting unit			✓	✓	✓					
6. Super-Seals™			✓	✓	✓	✓	✓	✓	✓	✓

The Scie-Plas horizontal range entails five individual series determined by gel tray size and sample throughput: -

The **MINI** and **MINI-PLUS** series, which comprise the HB-SET, H1-SET, HU6 and HU10 units, are ideal for screening and analysis of a wide range of samples, including PCR products, DNA mini-preps, plasmid vectors and restriction fragments. Each unit's compact size optimises the gel conditions and voltage gradient, allowing fast resolution of nucleic acids.

COMPLETE SYSTEM	APPLICATIONS			Part No.
	Teaching	Routine preparatory / analytical gel electrophoresis	Low throughput nucleic acid screening	
MINI				
Battery-powered horizontal mini-gel unit with built-in 6 x 7.5cm (W x L) casting tray	✓			HB-SET
'Easigel' fast-mini horizontal gel unit with built-in 10 x 8cm (W x L) casting tray	✓	✓		H1-SET
Mini horizontal gel unit with removable 6 x 7.5cm (W x L) casting tray		✓		HU6
MINI-PLUS				
Mini-Plus horizontal gel unit with removable 10 x 11.5cm (W x L) casting tray		✓	✓	HU10

The **MIDI** series, which includes the HU13 unit, accommodates standard gels for medium throughput analysis and preparation of nucleic acids, while the **STANDARD** HU15 provides the same comb-throughput and tray size options as industry standard units, with additional casting options.

COMPLETE SYSTEM	APPLICATIONS			Part No.
	Preparatory gel electrophoresis	Analytical gel electrophoresis	Medium throughput nucleic acid screening	
MIDI				
Midi horizontal gel unit with removable 12.8 x 15cm (W x L) casting tray		✓	✓	HU13
STANDARD				
Standard Format Midi horizontal gel unit with removable 15 x 15cm (W x L) casting tray	✓	✓	✓	HU15

The **MAXI** and **MAXI-PLUS** series, available in standard (HU20 and HU25) and cooled (CHU20 and CHU25) formats, are designed for the rapid, medium to high throughput screening of nucleic acids, such as HLA typing in population genetics studies. The cooled bases within the CHU20 and CHU25 units make these units ideal for hospital, university and industrial laboratories, which need to perform fast, large-scale analysis of nucleic acids at high voltage, but without compromising resolution.

COMPLETE SYSTEM	APPLICATIONS		Part No.
	Medium throughput nucleic acid screening	High throughput nucleic acid screening	
MAXI			
Maxi-Standard horizontal gel unit with removable 20 x 20cm (W x L) casting tray	✓		HU20
Maxi-Cooled horizontal gel unit with removable 20 x 20cm (W x L) casting tray	✓		CHU20
MAXI-PLUS			
Maxi-Plus Standard horizontal gel unit with removable 25 x 30cm (W x L) casting tray	✓	✓	HU25
Maxi-Plus Cooled horizontal gel unit with removable 25 x 30cm (W x L) casting tray	✓	✓	CHU25

Horizontal Gel Units

BENEFITS INCLUDE

- **Low voltage** - 2 non-rechargeable PP3 batteries, providing a maximum 18-Volt output, make the HB-SET ideal for use in schools and colleges where safety is paramount
- **Integrated safety lid** - ensures that the gel remains inaccessible during use
- **UV-transparent acrylic** - for direct visualisation of the gel within the tank, limiting the user's exposure to hazardous ethidium bromide
- **Ultra-compact tank** - minimises the buffer volume required to cover the gel, providing optimal control over the voltage gradient and run-time
- **Small size** - allows safe and easy transportation from the bench to the transilluminator
- **Cost-effective** - no need for expensive power supplies, while built-in plastic casting gates allow direct gel casting in the tank without additional costly accessories

TECHNICAL SPECIFICATION

Unit Dimensions (W x L x H)	11 x 17 x 3.5cm
Gel Dimensions (W x L)	6 x 7.5cm
Minimum Buffer Volume	50ml
Maximum Sample Capacity	32
Combs	2
Comb Thickness	1mm
Comb Throughput	8 to 12 samples
Comb Slots	2
Migration Distance Between Comb Slots	3.5cm
Running Voltage	18V
Recommended Power Source	2 x (9V) PP3 batteries

DO YOU NEED...?

AGAROSE	SEE PAGE 118
A POWER SUPPLY	SEE PAGES 91-92
A GEL DOCUMENTATION SYSTEM	SEE PAGE 96
GEL ANALYSIS SOFTWARE	SEE PAGE 97
A UV STERILISATION CABINET	SEE PAGE 98

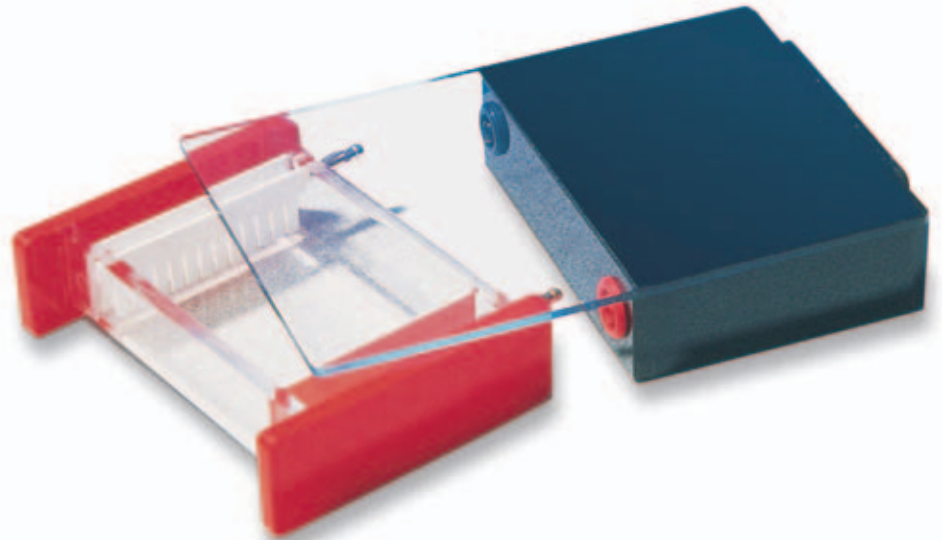

HB-SET Mini-gel

The HB-SET battery mini-gel electrophoresis unit is designed specifically with safety and cost in mind: in that no power supply is necessary.



TECHNICAL | Tip:

Enhance Resolution: 2 x TAE buffer can be used in units with low buffer volume to enhance resolution during extended runs.

ORDERING INFORMATION

Complete System	Part No.
Horizontal mini-gel unit with built-in casting tray and 2 x 1mm thick, 8-sample combs and 2 x non-rechargeable PP3 batteries	HB-SET

Replacement Parts & Accessories	Part No.
2 x casting gates	HB-CG

HB-SET Combs

Part No.	Thickness (mm)	Sample Throughput	Tooth Width (mm)	Max. Spacing (mm)	Sample Volume in a 5mm Deep Well (µl)
H2-C1-8	1	8	5.25	1	23
H2-C1-12	1	12	3.5	1	15



Easigel H1-SET

The Easigel H1-SET offers a swift and simple horizontal gel electrophoresis solution for standard preparative and analytical studies of nucleic acids.

BENEFITS INCLUDE

- **Plastic casting gates** - for direct gel casting in the tank with no need for costly accessories
- **Colour-coded combs** - 1 and 1.5mm thick, offer flexibility in sample-loading volume to a maximum 40-sample throughput
- **Quick-release lid** - disconnects the tank and lid simultaneously from the power supply for safe gel loading and disposal
- **UV-transparent acrylic** - for direct visualisation of the gel within the tank, limiting the user's exposure to hazardous ethidium bromide
- **Compact design** - minimises the buffer volume required to cover the gel, providing optimal control over the voltage gradient and run-time
- **Small size** - allows safe and easy transportation from the bench to the transilluminator

ORDERING INFORMATION

Complete System

'Easigel' horizontal gel unit with built-in casting tray and 2 x 1.5mm thick, 8-sample combs

Part No.

H1-SET

Replacement Parts & Accessories

2 x casting gates

H1-CG

2 x 1 metre power leads with shrouded

4mm power output connectors

CABLE-4

2 x 0.2mm thick, platinum electrode wire

PT-0.2

H1-SET Combs

Part No.	Thickness (mm)	Sample Throughput	Tooth Width (mm)	Max. Spacing (mm)	Sample Volume in a 5mm Deep Well (µl)
H1-C1-8	1	8	10	2	45
H1-C1-12	1	12	6	2	27
H1-C1-16	1	16	4	2	18
*H1-C1-20MC	1	20	2.8	2	12
H1-C1.5-8	1.5	8	10	2	65
H1-C1.5-12	1.5	12	6	2	40
H1-C1.5-16	1.5	16	4	2	27
*H1-C1.5-20MC	1.5	20	2.8	2	18

*Multichannel pipette compatible

TECHNICAL SPECIFICATION

Unit Dimensions (W x L x H)	13.5 x 15 x 3cm
Gel Dimensions (W x L)	10 x 8cm
Minimum Buffer Volume	50 ml
Maximum Sample Capacity	40
Combs	2
Comb Thickness	1 or 1.5mm
Comb Throughput	8 to 20 samples
Comb Slots	2
Migration Distance Between Comb Slots	3cm
Recommended Running Voltage (power supply)	70 to 90V
Power Output Connectors (diameter)	Shrouded, 4mm
Recommended Power Supply	Consort EV222

Horizontal Gel Units

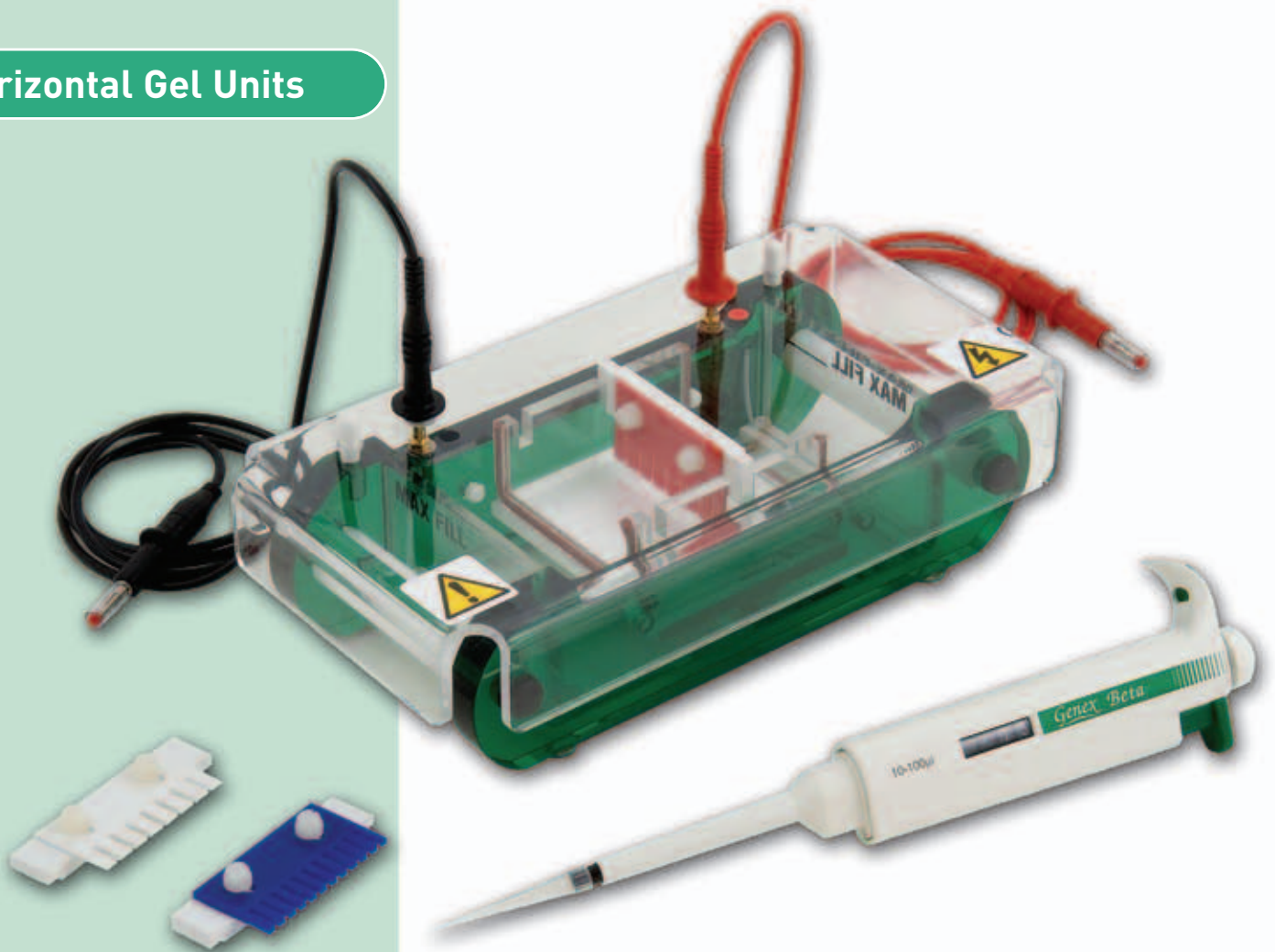

BENEFITS INCLUDE

- **Four casting options** - provide total flexibility in gel casting, either directly within the tank or externally when the tank is in use
- **Combs** - colour-coded and height-adjustable - offer complete control over loading volume and well depth to a maximum 32-sample throughput
- **Coloured loading strips** - for easy well detection when loading
- **Short 6cm gel length** - ideal for rapid separations
- **Compact tank** - reduces the buffer volume required to cover the gel, providing greater control over the voltage gradient and run-time
- **UV-transparent acrylic casting tray** - allows the user to image the gel without risk of damage due to handling
- **Side handles** - for safe and easy transportation around the laboratory

HU6 Mini Horizontal

The HU6 mini horizontal gel electrophoresis unit is ideal for routine preparatory and analytical electrophoresis techniques.

HU6 IN-TANK CASTING OPTIONS

HU6-UT - silicone gaskets, lining the HU6 casting tray, form a leak proof seal against the inner walls of the running chamber when the casting tray is turned at 90° to the direction of electrophoresis

HU6-SS - 6cm long Scie-Plas Super-Seals offer total versatility in casting, allowing the gel length to be tailored to each user's personal requirements

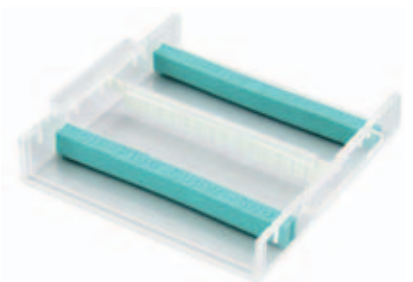
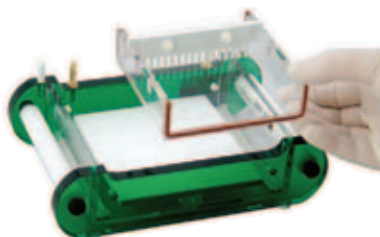

Replacement parts and accessories

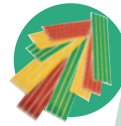

ORDERING INFORMATION

Complete System

Mini horizontal gel unit with removable casting tray and 2 x 1mm thick, 8-sample combs and coloured loading strips

Part No.

HU6

Replacement Parts & Accessories

1 x gel casting tray 6 x 7.5cm	HU6-UT
2 x silicone casting gates	HU6-SCG
1 x silicone gasket, 1 metre	HU-SG
2 x Scie-Plas Super-Seals	HU6-SS
6 x coloured loading strips	HU6-CS
1 x external casting unit for 3 gel casting trays	HU6-CU
1 x gel scoop	HU6-GS
2 x 0.2mm thick, platinum electrode wire	PT-0.2
2 x 1 metre power leads with shrouded 4mm power output connectors	CABLE-4

HU6 Combs

Part No.	Thickness (mm)	Sample Throughput	Tooth Width (mm)	Max. Spacing (mm)	Sample Volume in a 5mm Deep Well (µl)
HU6-C1-8	1	8	4.5	2	20
*HU6-C1-12MC	1	12	2.5	2	11
HU6-C1-16	1	16	2.2	1	10
HU6-C1.5-8	1.5	8	4.5	2	30
*HU6-C1.5-12MC	1.5	12	2.5	2	17
HU6-C1.5-16	1.5	16	2.2	1	15
HU6-C2-8	2	8	4.5	2	40
*HU6-C2-12MC	2	12	2.5	2	22
HU6-C2-16	2	16	2.2	1	20

*Multi-channel pipette compatible

TECHNICAL SPECIFICATION

Unit Dimensions (W x L x H)	13 x 24 x 6.5cm
Gel Dimensions (W x L)	6 x 7.5cm
Buffer Volume	325ml
Maximum Sample Capacity	32
Combs	2
Comb Thickness	1, 1.5 or 2mm
Comb Throughput	8 to 16 samples
Comb Slots	2
Migration Distance Between Comb Slots	3.5cm
Recommended Running Voltage	70 to 90V
Power Output Connectors (diameter)	Shrouded, 4mm
Recommended Power Supply	Consort EV222

HU6 EXTERNAL CASTING OPTIONS

HU6-SCG - silicone casting gates slot into the grooves at each end of the casting tray to form a leak-free seal

HU6-CU - silicone gaskets, seated in the groove of each casting tray, form a leak-free seal against the walls of the casting unit, allowing 3 gels to be cast simultaneously

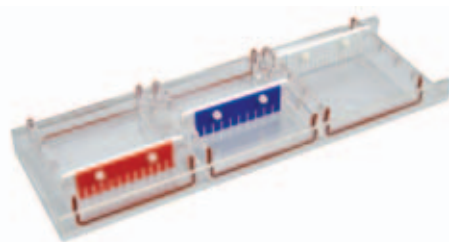

CASTING TIP Regardless of the casting method, ensure leak-free casting by lining the casting unit with agarose and allowing it to set before pouring the remainder of the hand-hot agarose mixture i.e. at approx. 50°C



Horizontal Gel Units

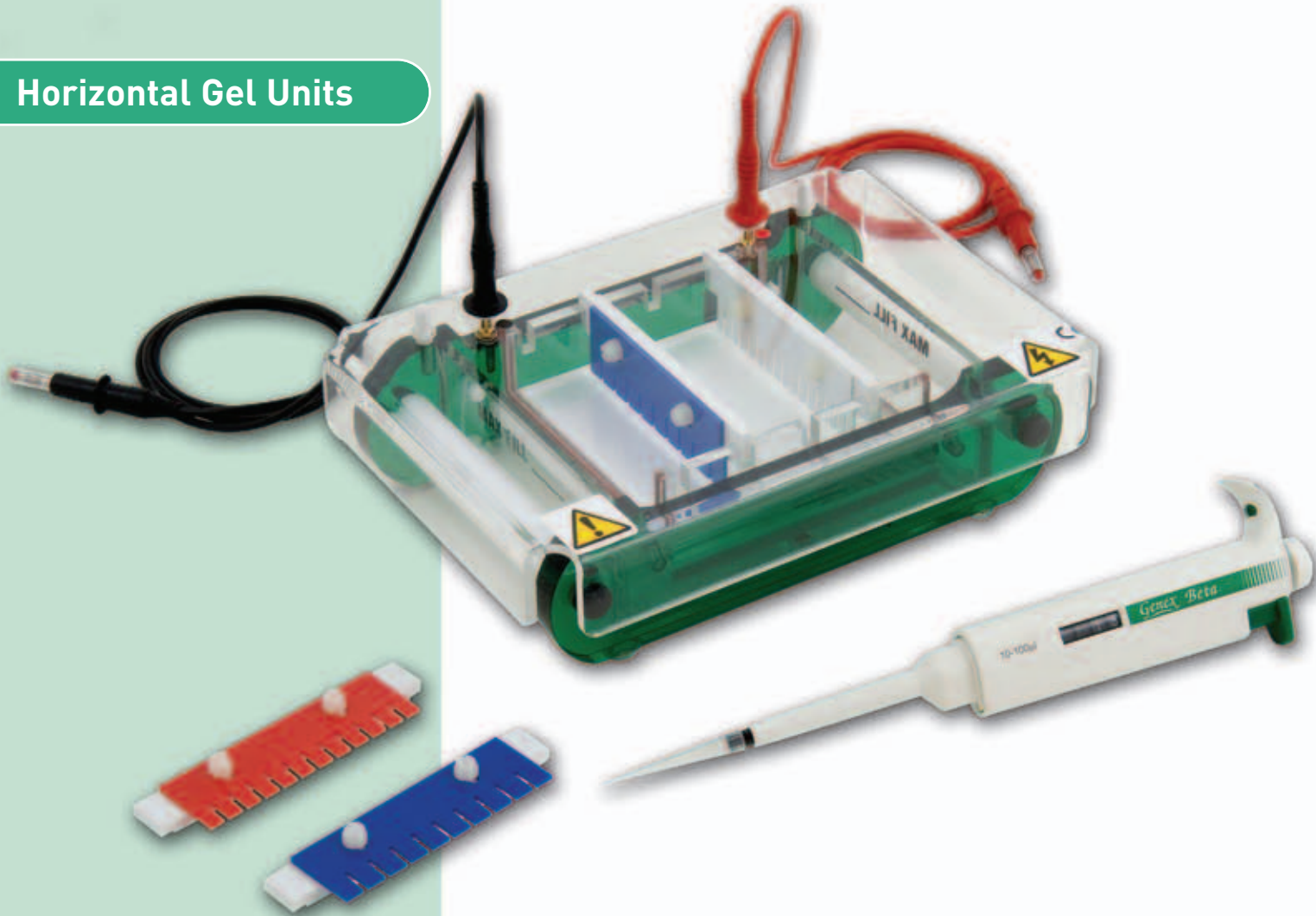

BENEFITS INCLUDE

- **Four casting options** - provide total flexibility in gel casting, either directly within the tank or externally when the tank is in use
- **Combs** - colour-coded and height-adjustable - offer complete control over loading volume and well depth to a maximum 80-sample throughput
- **Four comb positions** - at 2.5cm intervals along the tray for swift separation of multiple samples
- **Coloured loading strips** - for easy well detection when loading
- **Compact tank** - reduces the buffer volume required to cover the gel, providing greater control over the voltage gradient and run-time
- **UV-transparent acrylic casting tray** - allows the user to image the gel without risk of damage due to handling
- **Side handles** - for safe and easy transportation around the laboratory

HU10 Mini-Plus Horizontal

The HU10 mini-plus horizontal gel electrophoresis unit is ideal for routine preparatory and analytical electrophoresis techniques.

IN-TANK CASTING OPTIONS

HU10-UT - silicone gaskets, lining the HU10 casting tray, form a leak proof seal against the inner walls of the running chamber when the casting tray is turned at 90° to the direction of electrophoresis

HU10-SS - 10cm long Scie-Plas Super-Seals offer total versatility in casting, allowing the gel length to be tailored to each user's personal requirements

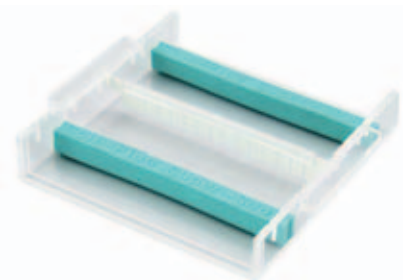
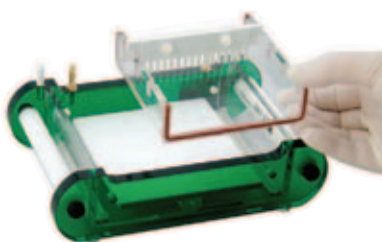

Replacement parts and accessories



ORDERING INFORMATION

Complete System

Mini-plus horizontal gel unit with removable casting tray and 2 x 1mm thick, 16-sample combs and coloured loading strips

Part No.

HU10

Replacement Parts & Accessories

1 x gel casting tray 10 x 11.5cm	HU10-UT
2 x silicone casting gates	HU10-SCG
1 x silicone gasket, 1 metre	HU-SG
2 x Scie-Plas Super-Seals	HU10-SS
12 x coloured loading strips	HU10-CS
1 x external casting unit for 3 gel casting trays	HU10-CU
1 x gel scoop	HU10-GS
2 x 0.2mm thick, platinum electrode wire	PT-0.2
2 x 1 metre power leads with shrouded 4mm power output connectors	CABLE-4

HU10 Combs

Part No.	Thickness (mm)	Sample Throughput	Tooth Width (mm)	Max. Spacing (mm)	Sample Volume in a 5mm Deep Well (µl)
HU10-C1-8	1	8	9	2.5	40
*HU10-C1-10MC	1	10	7	2	30
HU10-C1-12	1	12	5.5	2	25
HU10-C1-16	1	16	3.6	2	15
*HU10-C1-20MC	1	20	3	1.5	12
HU10-C1.5-8	1.5	8	9	2.5	60
*HU10-C1.5-10MC	1.5	10	7	2	45
HU10-C1.5-12	1.5	12	5.5	2	35
HU10-C1.5-16	1.5	16	3.6	2	25
*HU10-C1.5-20MC	1.5	20	3	1.5	20
HU10-C2-8	2	8	9	2.5	80
*HU10-C2-10MC	2	10	7	2	60
HU10-C2-12	2	12	5.5	2	50
HU10-C2-16	2	16	3.6	2	30
*HU10-C2-20MC	2	20	3	1.5	25

*Multi-channel pipette compatible

TECHNICAL SPECIFICATION

Unit Dimensions (W x L x H)	16.5 x 23 x 6.5cm
Gel Dimensions (W x L)	10 x 11.5cm
Buffer Volume	450ml
Maximum Sample Capacity	80
Combs	2
Comb Thickness	1, 1.5 or 2mm
Comb Throughput	8 to 20 samples
Comb Slots	4
Migration Distance Between Comb Slots	2.5cm
Recommended Running Voltage	75 to 125V
Power Output Connectors (diameter)	Shrouded, 4mm
Recommended Power Supply	Consort EV222

DO YOU NEED...?

AGAROSE	SEE PAGE 118
SUPER-SEALS™	SEE PAGE 33
A GEL LEVELING TABLE	SEE PAGE 34
UV TRANSILLUMINATORS	SEE PAGE 100

HU10 EXTERNAL CASTING OPTIONS

HU10-SCG - silicone casting gates slot into the grooves at each end of the casting tray to form a leak-free seal

HU10-CU - silicone gaskets, seated in the groove of each casting tray, form a leak-free seal against the walls of the casting unit, allowing 3 gels to be cast simultaneously

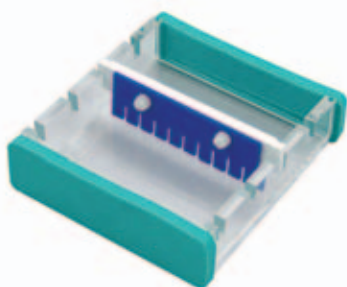

TECHNICAL TIP | Gasket too tight or loose? Simply remove the gaskets from the ends of the gel trays and refit into the groove. Refit with the gasket protruding slightly from the ends if the gel tray was too tight or with the gasket fitted below the top edges if the gasket was too loose.

Horizontal Gel Units

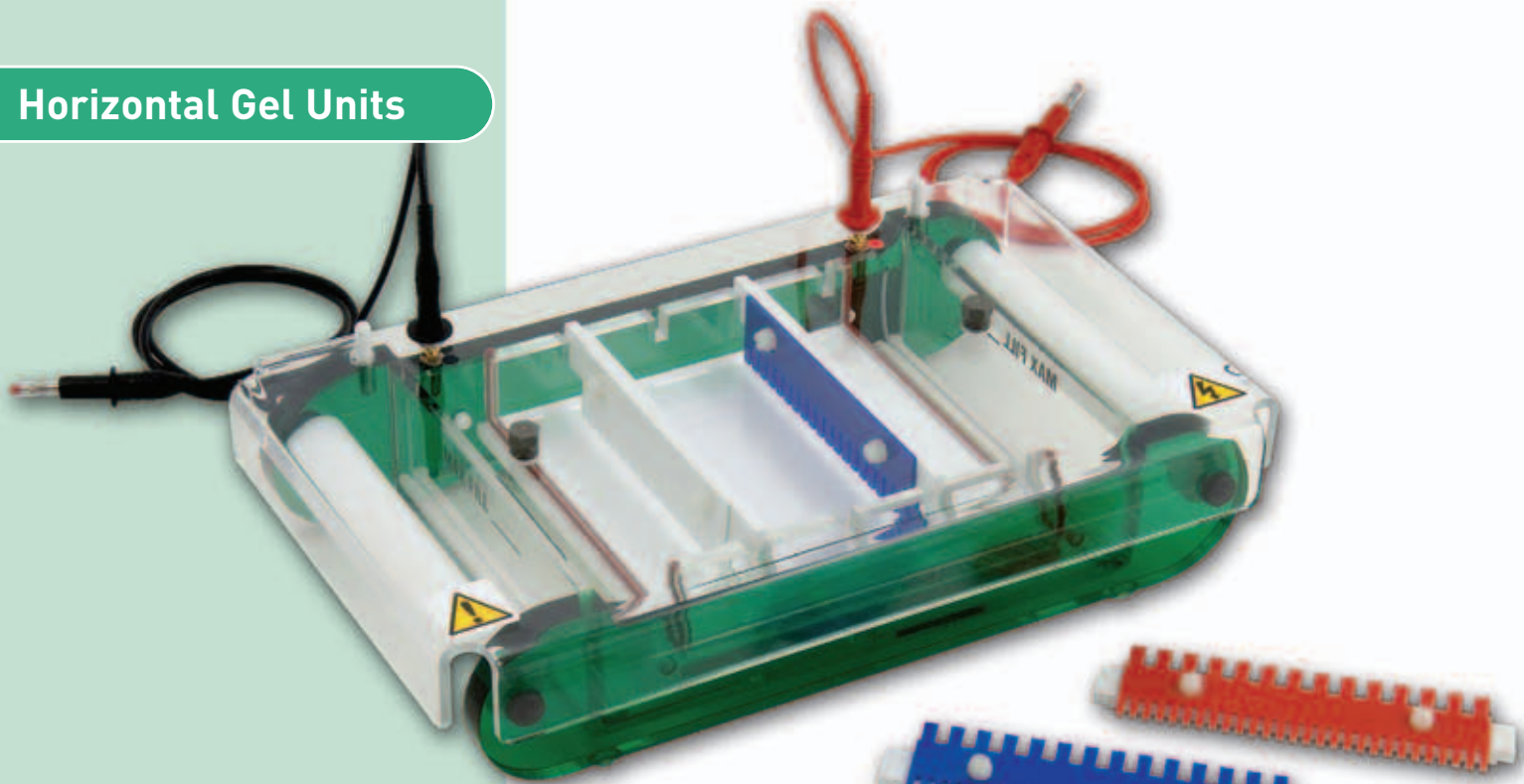

BENEFITS INCLUDE

- **Four casting options** - provide total flexibility in gel casting, either directly within the tank or externally when the tank is in use
- **Combs** - colour-coded and height-adjustable - offer complete control over loading volume and well depth to a maximum 112-sample throughput
- **Four comb positions** - at 3.5cm intervals along the tray for faster separation of multiple samples
- **Buffer recirculation ports** - may be connected to a peristaltic pump for buffer recirculation during electrophoresis to maintain buffer pH and prevent ionic gradient formation
- **Coloured loading strips** - for easy well detection when loading
- **Compact tank** - reduces the buffer volume required to cover the gel, providing greater control over the voltage gradient and run-time
- **UV-transparent acrylic casting tray** - allows the user to image the gel without risk of damage due to handling
- **Side handles** - for safe and easy transportation around the laboratory

HU13 Midi Horizontal

The HU13 midi horizontal gel electrophoresis unit is ideal for analytical and preparative studies of nucleic acids.

HU13 IN-TANK CASTING OPTIONS

HU13-UT - silicone gaskets, lining the HU10 casting tray, form a leak proof seal against the inner walls of the running chamber when the casting tray is turned at 90° to the direction of electrophoresis

HU13-SS - 13cm long Scie-Plas Super-Seals offer total versatility in casting, allowing the gel length to be tailored to each user's personal requirements

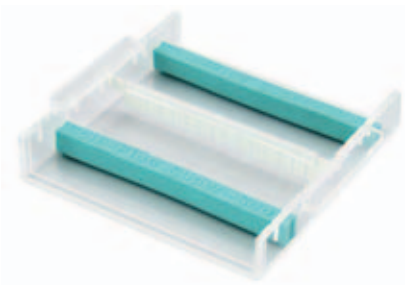
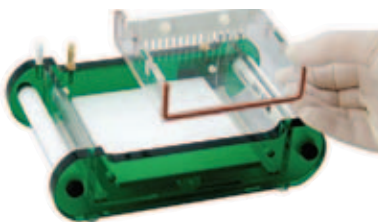

ORDERING INFORMATION

Complete System

Midi horizontal gel unit with removable casting tray and 2 x 1mm thick, 16-sample combs, coloured loading strips and buffer recirculation ports

Part No.

HU13

Replacement Parts & Accessories

1 x gel casting tray 12.8 x 15cm	HU13-UT
2 x buffer recirculation ports	HU-BRP
2 x silicone casting gates	HU13-SCG
1 x silicone gasket, 1 metre	HU-SG
2 x Scie-Plas Super-Seals	HU13-SS
12 x coloured loading strips	HU13-CS
1 x external casting unit for 3 gel casting trays	HU13-CU
1 x gel scoop	HU13-GS
2 x 0.2mm thick, platinum electrode wire	PT-0.2
2 x 1metre power leads with shrouded 4mm power output connectors	CABLE-4

HU13 Combs

Part No.	Thickness (mm)	Sample Throughput	Tooth Width (mm)	Max. Spacing (mm)	Sample Volume in a 5mm Deep Well (µl)
HU13-C1-10	1	10	9.5	2.5	40
HU13-C1-12MC	1	12	8	2	35
HU13-C1-16	1	16	5.5	2	25
HU13-C1-20	1	20	4	2	17
HU13-C1-24	1	24	3	2	13
*HU13-C1-28MC	1	28	3	1.5	13
HU13-C1.5-10	1.5	10	9.5	2.5	60
HU13-C1.5-12MC	1.5	12	8	2	50
HU13-C1.5-16	1.5	16	5.5	2	35
HU13-C1.5-20	1.5	20	4	2	25
HU13-C1.5-24	1.5	24	3	2	20
*HU13-C1.5-28MC	1.5	28	3	1.5	20
HU13-C2-10	2	10	9.5	2.5	85
HU13-C2-12MC	2	12	8	2	70
HU13-C2-16	2	16	5.5	2	50
HU13-C2-20	2	20	4	2	35
HU13-C2-24	2	24	3	2	25
*HU13-C2-28MC	2	28	3	1.5	25

*Multi-channel pipette compatible

TECHNICAL SPECIFICATION

Unit Dimensions (W x L x H)	20 x 32 x 7cm
Gel Dimensions (W x L)	12.8 x 15cm
Buffer Volume	900ml
Buffer Recirculation Ports	2
Maximum Sample Capacity	112
Combs	2
Comb Thickness	1, 1.5 or 2mm
Comb Throughput	10 to 28 samples
Comb Slots	4
Migration Distance Between Comb Slots	3.5cm
Recommended Running Voltage	100 to 125V
Power Output Connectors (diameter)	Shrouded, 4mm
Recommended Power Supply	Consort EV243

DO YOU NEED...?

ELECTROPHORESIS BUFFERS	SEE PAGE 119
COLOURED LOADING STRIPS	SEE PAGE 34
A POWER SUPPLY	SEE PAGES 91-92
AN EXTERNAL CASTING UNIT	SEE PAGE 32
A GEL SCOOP	SEE PAGE 34

HU13 EXTERNAL CASTING OPTIONS

HU13-SCG - silicone casting gates slot into the grooves at each end of the casting tray to form a leak-free seal



HU13-CU - silicone gaskets, seated in the groove of each casting tray form a leak-free seal against the walls of the casting unit, allowing 3 gels to be cast simultaneously

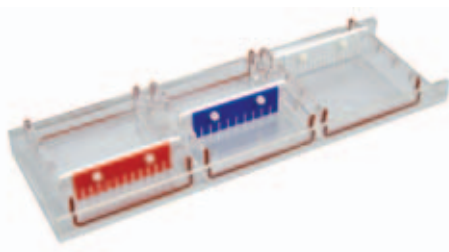

TECHNICAL TIP | DNA Mobility:

DNA fragments as small as 1kb or less can be separated using agarose gel electrophoresis. For fragments smaller than 0.1kb, polyacrylamide gels are more suitable.

Horizontal Gel Units

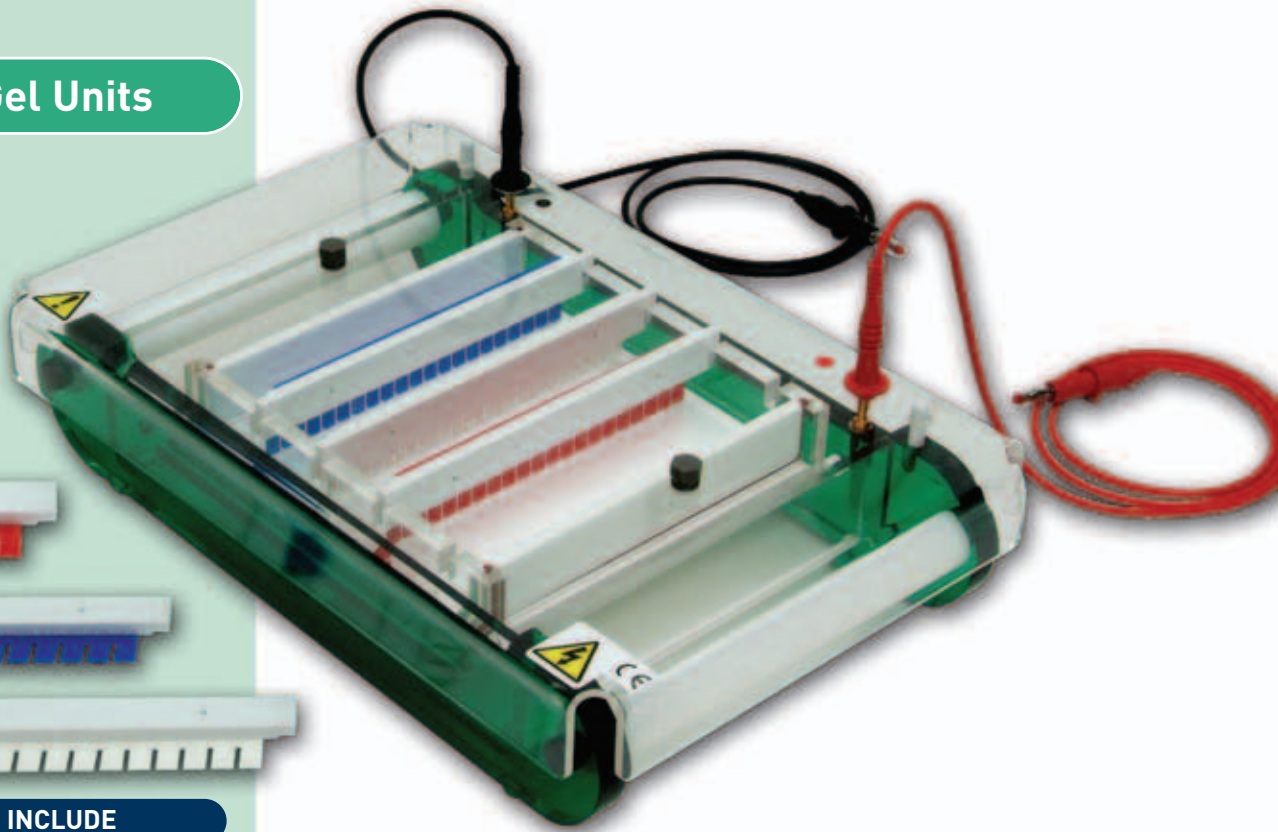

BENEFITS INCLUDE

- **The market standard** - a 15 x 15cm gel tray, with comb options ranging from 1 to 30 samples, is currently the most popular format in today's market
- **Four comb slots** - at 3.5cm intervals along the tray for faster separation of a maximum 120 samples
- **Multi-channel pipette compatible combs** - with a maximum 30-sample throughput reduce gel-loading time, while preparatory combs enable nucleic acids to be scaled-up for cloning
- **Combs** - colour-coded and height-adjustable - offer complete control over loading volume and well depth
- **Buffer recirculation ports** - may be connected to a peristaltic pump for buffer recirculation during electrophoresis to maintain buffer pH and prevent ionic gradient formation
- **Coloured loading strips** - for easy well detection when loading
- **UV-transparent acrylic casting tray** - allows the user to image the gel without risk of damage due to handling
- **Side handles** - for safe and easy transportation around the laboratory



HU15 Standard Horizontal

The HU15 standard horizontal gel electrophoresis unit provides the comb throughput and tray-size options most popular in today's market, but with additional casting options.

HU15 CASTING OPTIONS

HU15-CG - casting gates with integral silicone seals effectively seal the tray without the need for tape, provided the silicone gasket faces outwards as shown



HU15-SS - 15cm long Scie-Plas Super-Seals offer total versatility in casting, allowing the gel length to be tailored to each user's personal requirements

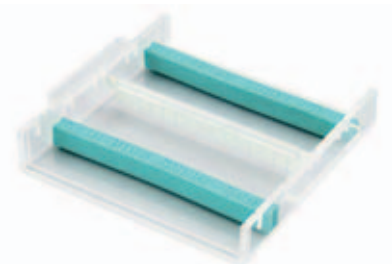

CASTING TIP Regardless of the casting method, ensure leak-free casting by lining the casting unit with agarose and allowing it to set before pouring the remainder of the hand-hot agarose mixture i.e. at approx. 50°C



Replacement parts and accessories

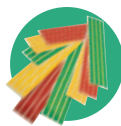

ORDERING INFORMATION

Complete System

Standard horizontal gel unit with removable casting tray, including casting gates with integral silicone seals, 2 x 1mm thick, 16-sample combs, coloured loading strips and buffer recirculation ports

Part No.

HU15

Replacement Parts & Accessories

1 x gel casting tray, 15 x 15cm, including casting gates with integral silicone seals

HU15-UT

2 x buffer recirculation ports

HU-BRP

2 x casting gates with integral silicone seals

HU15-CG

1 x silicone gasket, 1 metre

HU-SG

2 x Scie-Plas Super-Seals

HU15-SS

12 x coloured loading strips

HU15-CS

1 x gel scoop

HU15-GS

2 x 0.2mm thick, platinum electrode wire

PT-0.2

2 x 1 metre power leads with shrouded

4mm power output connectors

CABLE-4

HU15 Combs

Part No.	Thickness (mm)	Sample Throughput	Tooth Width (mm)	Max. Spacing (mm)	Sample Volume in a 5mm Deep Well (µl)
HU15-C1-10	1	10	12.8	2	64
HU15-C1-15	1	15	7	2	35
*HU15-C1-16MC	1	16	6.4	2	32
HU15-C1-20	1	20	5.9	2	29
HU15-C1-25	1	25	3.5	2	17
*HU15-C1-30MC	1	30	2.5	2	12
HU15-C1.5-10	1.5	10	12.8	2	96
HU15-C1.5-15	1.5	15	7	2	52
*HU15-C1.5-16MC	1.5	16	6.4	2	48
HU15-C1.5-20	1.5	20	5.9	2	43
HU15-C1.5-25	1.5	25	3.5	2	25
*HU15-C1.5-30MC	1.5	30	2.5	2	18
HU15-C2-10	2	10	12.8	2	128
HU15-C2-15	2	15	7	2	70
*HU15-C2-16MC	2	16	6.4	2	64
HU15-C2-20	2	20	5.9	2	58
HU15-C2-25	2	25	3.5	2	34
*HU15-C2-30MC	2	30	2.5	2	24

*Multi-channel pipette compatible

TECHNICAL SPECIFICATION

Unit Dimensions (W x L x H)	21.5 x 33.5 x 7cm
Gel Size (W x L)	15 x 15cm
Buffer Volume	1200ml
Buffer Recirculation Ports	2
Maximum Sample Capacity	120
Combs	2
Comb Thickness	1, 1.5 or 2mm
Comb Throughput	1 to 30 samples
Comb Slots	4
Migration Distance Between Comb Slots	3.5cm
Recommended Running Voltage	100 to 125V
Power Output Connectors (diameter)	Shrouded, 4mm
Recommended Power Supply	Consort EV243



**ELECTROPHORESIS
CHEMICALS**
SEE PAGES 117-123

Horizontal Gel Units



BENEFITS INCLUDE

- **Large format** - 20 x 20cm gel tray is ideal for high-resolution techniques, such as screening PCR® products and RFLP analysis
- **Four comb slots** - at 5cm intervals along the tray for faster separation of a maximum 168 samples
- **Multi-channel pipette compatible combs** - with a maximum 42-sample throughput - reduce gel-loading time
- **Combs** - colour-coded and height-adjustable - offer complete control over loading volume and well depth
- **Buffer recirculation ports** - may be connected to a peristaltic pump for buffer recirculation during electrophoresis to maintain buffer pH and prevent ionic gradient formation
- **Coloured loading strips** - for easy well detection when loading
- **UV-transparent acrylic casting tray** - allows the user to image the gel without risk of damage due to handling
- **Side handles** - for safe and easy transportation around the laboratory
- **Cooled version available** - see page 18



HU20 Maxi-Standard Horizontal

The HU20 maxi-standard horizontal gel electrophoresis unit is ideal for high-resolution analytical and preparative studies of nucleic acids.

HU20 CASTING OPTIONS

HU20-CG - casting gates with integral silicone seals effectively seal the tray without the need for tape, provided the silicone gasket faces outwards as shown



HU20-SS - 20cm long Scie-Plas Super-Seals offer total versatility in casting, allowing the gel length to be tailored to each user's personal requirements

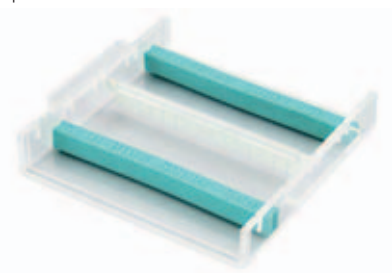

Replacement parts and accessories



ORDERING INFORMATION

Complete System

Maxi-standard horizontal gel unit with removable casting tray, including casting gates with integral silicone seals, 2 x 1mm thick, 16-sample combs, coloured loading strips and buffer recirculation ports

Part No.

HU20

Replacement Parts & Accessories

1 x gel casting tray, 20 x 20cm, including casting gates with integral silicone seals

HU20-UT

2 x buffer recirculation ports

HU-BRP

2 x casting gates with integral silicone seals

HU20-CG

1 x silicone gasket, 1 metre

HU-SG

2 x Scie-Plas Super-Seals

HU20-SS

12 x coloured loading strips

HU20-CS

1 x gel scoop

HU20-GS

2 x 0.2mm thick, platinum electrode wire

PT-0.2

2 x 1 metre power leads with shrouded

4mm power output connectors

CABLE-4

HU20 Combs

Part No.	Thickness (mm)	Sample Throughput	Tooth Width (mm)	Max. Spacing (mm)	Sample Volume in a 5mm Deep Well (µl)
HU20-C1-16	1	16	8.5	3	35
*HU20-C1-20MC	1	20	7	2	30
HU20-C1-28	1	28	5	2	20
*HU20-C1-40MC	1	40	3	2	13
HU20-C1.5-16	1.5	16	8.5	3	55
*HU20-C1.5-20MC	1.5	20	7	2	45
HU20-C1.5-28	1.5	28	5	2	30
*HU20-C1.5-40MC	1.5	40	3	2	19
HU20-C2-16	2	16	8.5	3	75
*HU20-C2-20MC	2	20	7	2	60
HU20-C2-28	2	28	5	2	40
*HU20-C2-40MC	2	40	3	2	25

*Multi-channel pipette compatible



TECHNICAL TIP | RNA

Mobility: Either before or during electrophoresis, RNA should be denatured. For example:-

- RNA fragments which have been denatured with glyoxal and dimethyl sulphoxide can be separated on neutral agarose gels; or
- RNA can be fractionated on agarose gels containing methylmercuric hydroxide or formaldehyde.
- RNA samples usually require longer runs or buffers that are easily depleted, so it is necessary to circulate the buffer. Northern analyses should not be run on a mini-gel tank.

TECHNICAL SPECIFICATION

Unit Dimensions (W x L x H)	27 x 47.5 x 8cm
Gel Size (W x L)	20 x 20cm
Buffer Volume	2200ml
Buffer Recirculation Ports	2
Maximum Sample Capacity	168
Combs	2
Comb Thickness	1, 1.5 or 2mm
Comb Throughput	16 to 42 samples
Comb Slots	4
Migration Distance Between Comb Slots	5cm
Recommended Running Voltage	150 to 175V
Power Output Connectors (diameter)	Shrouded, 4mm
Recommended Power Supply	Consort EV243

Horizontal Gel Units



BENEFITS INCLUDE

- **Large format** - 25 x 30cm gel tray is ideal for high-throughput techniques, such as HLA typing and screening PCR® products
- **Twelve comb slots** - at 2cm intervals along the tray for rapid, high throughput separation of a maximum 624 samples
- **Multi-channel pipette compatible combs** - with a maximum 52-sample throughput - allow samples to be loaded quickly and easily from 96 and 384-well thermal cyclers
- **Combs** - colour-coded and height-adjustable - offer complete control over loading volume and well depth
- **Buffer recirculation ports** - may be connected to a peristaltic pump for buffer recirculation during electrophoresis to maintain buffer pH and prevent ionic gradient formation
- **Coloured loading strips** - for easy well detection when loading
- **UV-transparent acrylic casting tray** - allows the user to image the gel without risk of damage due to handling
- **Side handles** - for safe and easy transportation around the laboratory
- **Cooled version available** - see page 20

HU25 Maxi-Plus Standard Horizontal

The HU25 maxi-plus standard horizontal gel electrophoresis unit is ideal for high throughput analysis of nucleic acids.

HU25 CASTING OPTIONS

HU25-CG - casting gates with integral silicone seals effectively seal the tray without the need for tape, provided the silicone gasket faces outwards as shown



HU25-SS - 25cm long Scie-Plas Super-Seals offer total versatility in casting, allowing the gel length to be tailored to each user's personal requirements

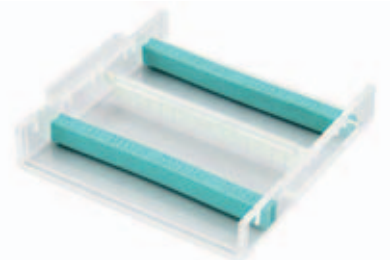

Replacement parts and accessories



ORDERING INFORMATION

Complete System

Maxi-plus standard horizontal gel unit with removable casting tray, including casting gates with integral silicone seals, 6 x 1mm thick, 26-sample combs, coloured loading strips and buffer recirculation ports

Part No.

HU25

Replacement Parts & Accessories

1 x gel casting tray, 25 x 30cm, including casting gates with integral silicone seals

HU25-UT

2 x buffer recirculation ports

HU-BRP

2 x casting gates with integral silicone seals

HU25-CG

1 x silicone gasket, 1 metre

HU-SG

2 x Scie-Plas Super-Seals

HU25-SS

36 x coloured loading strips

HU25-CS

1 x gel scoop

HU25-GS

2 x 0.2mm thick, platinum electrode wire

PT-0.2

2 x 1 metre power leads with shrouded

4mm power output connectors

CABLE-4

HU25 Combs

Part No.	Thickness (mm)	Sample Throughput	Tooth Width (mm)	Max. Spacing (mm)	Sample Volume in a 5mm Deep Well (µl)
*HU25-C1-26MC	1	26	7	2	30
*HU25-C1-52MC	1	52	3	1.5	13
*HU25-C1.5-26MC	1.5	26	7	2	45
*HU25-C1.5-52MC	1.5	52	3	1.5	20
*HU25-C2-26MC	2	26	7	2	60
*HU25-C2-52MC	2	52	3	1.5	25

*Multi-channel pipette compatible



TECHNICAL TIP |

Electrophoresis Buffer Selection: TAE buffer provides optimal resolution of fragments >4kb in length, while for 0.1 to 3kb fragments TBE buffer should be selected. TBE has both a higher buffering capacity and lower conductivity than TAE and therefore should be used for high-voltage electrophoresis. Additionally, TBE buffer generates less heat than TAE at an equivalent voltage and does not allow a significant pH drift.

TECHNICAL SPECIFICATION

Unit Dimensions (W x L x H)	33 x 56 x 9cm
Gel Size (W x L)	25 x 30cm
Buffer Volume	3000mL
Buffer Recirculation Ports	2
Maximum Sample Capacity	624
Combs	6
Comb Thickness	1, 1.5 or 2mm
Comb Throughput	26 to 52 samples
Comb Slots	12
Migration Distance Between Comb Slots	2cm
Recommended Running Voltage	150 to 200V
Power Output Connectors (diameter)	Shrouded, 4mm
Recommended Power Supply	Consort EV243

DO YOU NEED...?

SUPER-SEALS™
A POWER SUPPLY
A GEL SCOOP
UV TRANSILLUMINATORS

SEE PAGE 33
SEE PAGES 91-92
SEE PAGE 34
SEE PAGE 100

Horizontal Gel Units

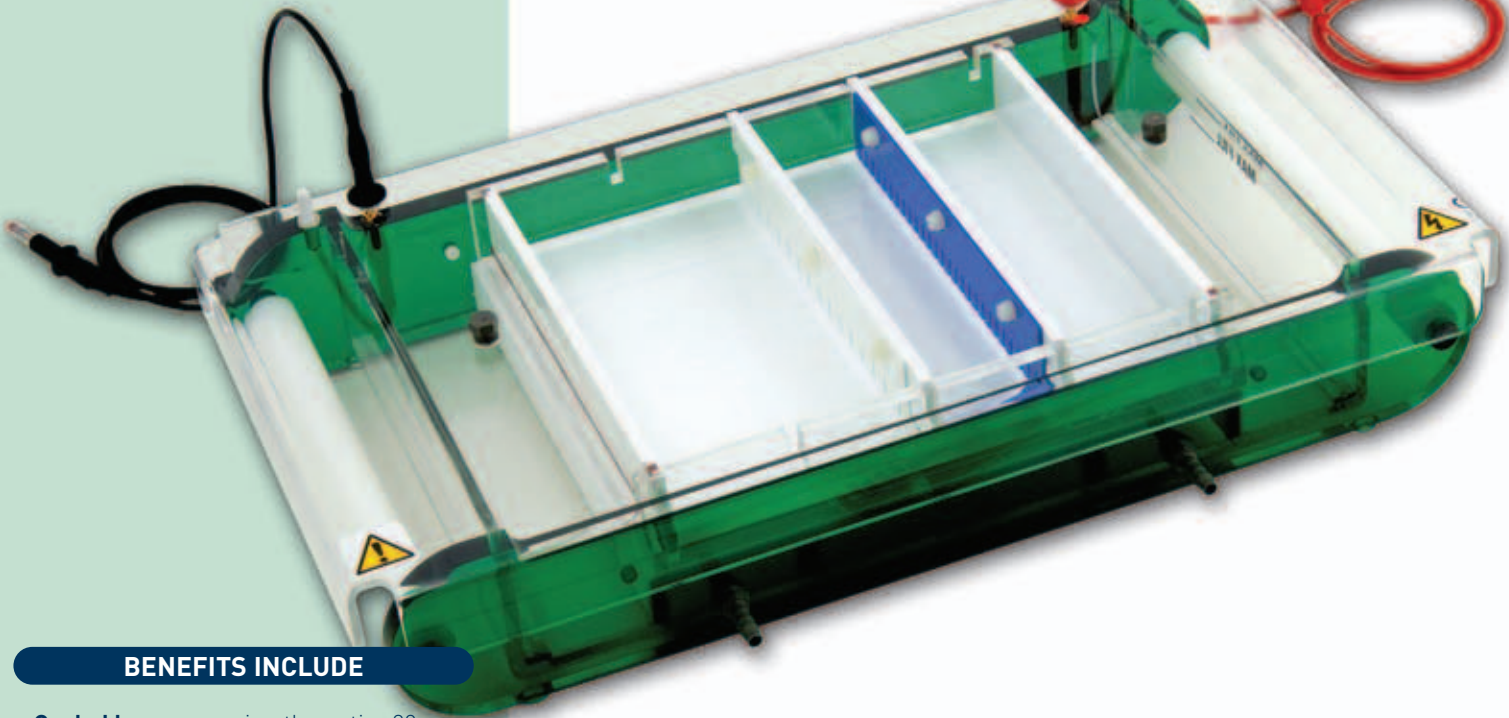

BENEFITS INCLUDE

- **Cooled base** - covering the entire 20 x 20cm gel tray - allows separations to be performed faster and at higher voltage, without loss of resolution
- **Cooling ports** - connect the cooled base either to the laboratory water supply or the optional external chiller (Page 82) for enhanced cooling
- **Four comb slots** - at 5cm intervals along the tray for faster separation of a maximum 168 samples
- **Multichannel pipette compatible combs** - with a maximum 42-sample throughput - reduce gel-loading time
- **Combs** - colour-coded and height-adjustable - offer complete control over loading volume and well depth
- **Buffer recirculation ports** - may be connected to a peristaltic pump for buffer recirculation during electrophoresis to maintain buffer pH and prevent ionic gradient formation
- **Coloured loading strips** - for easy well detection when loading
- **UV-transparent acrylic casting tray** - allows the user to image the gel without risk of damage due to handling
- **Side handles** - for safe and easy transportation around the laboratory

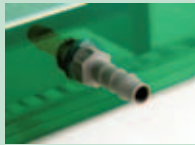

CHU20 Maxi-Cooled Horizontal

The CHU20 maxi-cooled horizontal gel electrophoresis unit allows analytical and preparative studies of nucleic acids to be performed quickly at high voltage without compromising resolution.

CHU20 CASTING OPTIONS

HU20-CG - casting gates with integral silicone seals effectively seal the tray without the need for tape, provided the silicone gasket faces outwards as shown



HU20-SS - 20cm long Scie-Plas Super-Seals offer total versatility in casting, allowing the gel length to be tailored to each user's personal requirements



Replacement parts and accessories



ORDERING INFORMATION

Complete System

Maxi-cooled horizontal gel unit with removable casting tray, including casting gates with integral silicone seals, 2 x 1mm thick, 16-sample combs, coloured loading strips and buffer recirculation ports

Part No.

CHU20

Replacement Parts & Accessories

1 x gel casting tray, 20 x 20cm, including casting gates with integral silicone seals
 2 x buffer recirculation ports
 2 x casting gates with integral silicone seals
 1 x silicone gasket, 1 metre
 2 x Scie-Plas Super-Seals
 12 x coloured loading strips
 1 x gel scoop
 2 x 0.2mm thick, platinum electrode wire
 2 x 1 metre power leads with shrouded
 4mm power output connectors

HU20-UT
 HU-BRP
 HU20-CG
 HU-SG
 HU20-SS
 HU20-CS
 HU20-GS
 PT-0.2
 CABLE-4

CHU20 Combs

Part No.	Thickness (mm)	Sample Throughput	Tooth Width (mm)	Max. Spacing (mm)	Sample Volume in a 5mm Deep Well (µl)
HU20-C1-16	1	16	8.5	3	35
*HU20-C1-20MC	1	20	7	2	30
HU20-C1-28	1	28	5	2	20
*HU20-C1-40MC	1	40	3	2	13
HU20-C1.5-16	1.5	16	8.5	3	55
*HU20-C1.5-20MC	1.5	20	7	2	45
HU20-C1.5-28	1.5	28	5	2	30
*HU20-C1.5-40MC	1.5	40	3	2	19
HU20-C2-16	2	16	8.5	3	75
*HU20-C2-20MC	2	20	7	2	60
HU20-C2-28	2	28	5	2	40
*HU20-C2-40MC	2	40	3	2	25

*Multi-channel pipette compatible



TECHNICAL TIP I

Temperature: Electrophoresis at high voltages produces heat. Additionally, high-conductivity buffers such as TAE generate more heat than low-conductivity buffers. Care should be taken in agarose gel electrophoresis with voltages greater than 175 Volts, as heat build up can generate gel artefacts such as S-shaped migration fronts, and in extended electrophoresis runs can even melt the agarose gel. With high voltage electrophoresis, the use of low-melting point agarose gels should be avoided.

TECHNICAL SPECIFICATION

Unit Dimensions (W x L x H)	27 x 47.5 x 8cm
Gel Size (W x L)	20 x 20cm
Buffer Volume	2200ml
Buffer Recirculation Ports	2
Maximum Sample Capacity	168
Combs	2
Comb Thickness	1, 1.5 or 2mm
Comb Throughput	16 to 42 samples
Comb Slots	6
Cooling Ports	2
Migration Distance Between Comb Slots	5cm
Recommended Running Voltage	150 to 225V
Power Output Connectors (diameter)	Shrouded, 4mm
Recommended Power Supply	Consort EV243

Horizontal Gel Units

BENEFITS INCLUDE

- **Cooled base** - covering the entire 25 x 30cm gel tray - allows separations to be performed faster and at higher voltage, without loss of resolution
- **Cooling ports** - connect the cooled base either to the laboratory water supply or the optional external chiller (Page 82) for enhanced cooling
- **Twelve comb slots** - at 2cm intervals along the tray for rapid, high throughput separation of a maximum 624 samples
- **Multi-channel pipette compatible combs** - with a maximum 52-sample throughput - allow samples to be loaded quickly and easily from 96 and 384-well thermal cyclers
- **Combs** - colour-coded and height-adjustable - offer complete control over loading volume and well depth
- **Buffer recirculation ports** - may be connected to a peristaltic pump for buffer recirculation during electrophoresis to maintain buffer pH and prevent ionic gradient formation
- **Coloured loading strips** - for easy well detection when loading
- **UV-transparent acrylic casting tray** - allows the user to image the gel without risk of damage due to handling
- **Side handles** - for safe and easy transportation around the laboratory

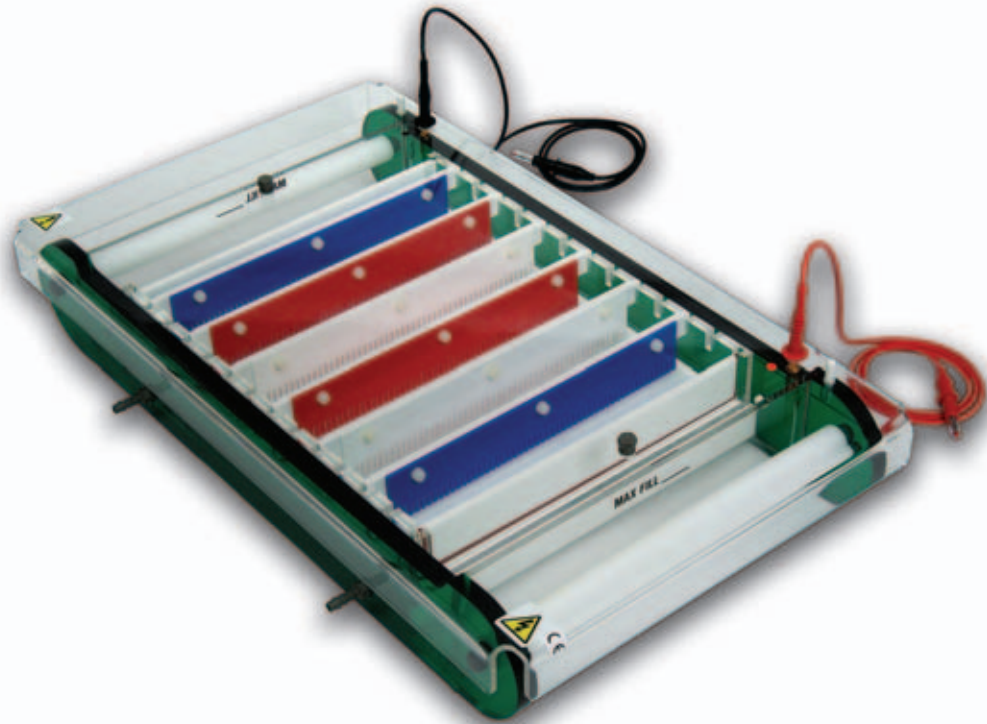

CHU25 Maxi-Plus Cooled Horizontal

The CHU25 maxi-plus cooled horizontal gel electrophoresis unit allows high throughput screening of nucleic acids to be performed quickly at high voltage without compromising resolution.

CHU25 CASTING OPTIONS

HU25-CG - casting gates with integral silicone seals effectively seal the tray without the need for tape, provided the silicone gasket faces outwards as shown



HU25-SS - 25cm long Scie-Plas Super-Seals offer total versatility in casting, allowing the gel length to be tailored to each user's personal requirements

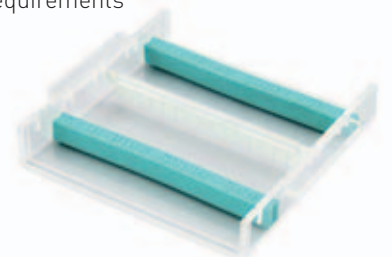

CASTING TIP Regardless of the casting method, ensure leak-free casting by lining the casting unit with agarose and allowing it to set before pouring the remainder of the hand-hot agarose mixture i.e. at approx. 50°C





TECHNICAL TIP | Separation Performance: Gel concentration, running buffer, voltage, temperature, nucleic acid conformation and the presence of ethidium bromide all affect separation results. To establish the progress of double stranded DNA, ethidium bromide (0.5µg/ml) is often added to the running buffer. The dye's fluorescent properties allow the bands to be visualised under a UV lamp. However, ethidium bromide may slow down the DNA migration rate by approx. 15%. As an alternative, after electrophoresis, the gel may be stained in an ethidium bromide solution (0.5µg/ml H₂O) for 15 to 60 minutes and then viewed or photographed on a UV transilluminator. Note: The staining time should be minimised to prevent small nucleic acid fragments from diffusing out of the gel. Background fluorescence of unbound ethidium bromide can be minimised through destaining by soaking the gel for 5 minutes in 0.01M MgCl₂, or for 30 minutes in de-ionised water.

Replacement parts and accessories



ORDERING INFORMATION

Complete System

Maxi-plus cooled horizontal gel unit with removable casting tray, including casting gates with integral silicone seals, 6 x 1mm thick, 26-sample combs, coloured loading strips and buffer recirculation ports

Part No.

CHU25

Replacement Parts & Accessories

1 x gel casting tray, 25 x 30cm, including casting gates with integral silicone seals

HU25-UT

2 x buffer recirculation ports

HU-BRP

2 x casting gates with integral silicone seals

HU25-CG

1 x silicone gasket, 1 metre

HU-SG

2 x Scie-Plas Super-Seals

HU25-SS

36 x coloured loading strips

HU25-CS

1 x gel scoop

HU25-GS

2 x 0.2mm thick, platinum electrode wire

PT-0.2

2 x 1 metre power leads with shrouded

4mm power output connectors

CABLE-4

CHU25 Combs

Part No.	Thickness (mm)	Sample Throughput	Tooth Width (mm)	Max. Spacing (mm)	Sample Volume in a 5mm Deep Well (µl)
*HU25-C1-26MC	1	26	7	2	30
*HU25-C1-52MC	1	52	3	1.5	13
*HU25-C1.5-26MC	1.5	26	7	2	45
*HU25-C1.5-52MC	1.5	52	3	1.5	20
*HU25-C2-26MC	2	26	7	2	60
*HU25-C2-52MC	2	52	3	1.5	25

*Multi-channel pipette compatible

TECHNICAL SPECIFICATION

Unit Dimensions (W x L x H)	33 x 56 x 9cm
Gel Size (W x L)	25 x 30cm
Buffer Volume	3000ml
Buffer Recirculation Ports	2
Maximum Sample Capacity	624
Combs	6
Comb Thickness	1, 1.5 or 2mm
Comb Throughput	26 to 52 samples
Comb Slots	12
Cooling Ports	2
Migration Distance	2cm
Between Comb Slots	
Recommended Running Voltage	150 to 250V
Power Output Connectors (diameter)	Shrouded, 4mm
Recommended Power Supply	Consort EV243

DO YOU NEED...?

A UV STERILISATION CABINET	SEE PAGE 98
A THERMAL CYCLER	SEE PAGE 99
A RECIRCULATING CHILLER	SEE PAGE 82
A BUFFER RECIRCULATION PUMP	SEE PAGE 35
A GEL DOCUMENTATION SYSTEM	SEE PAGE 96



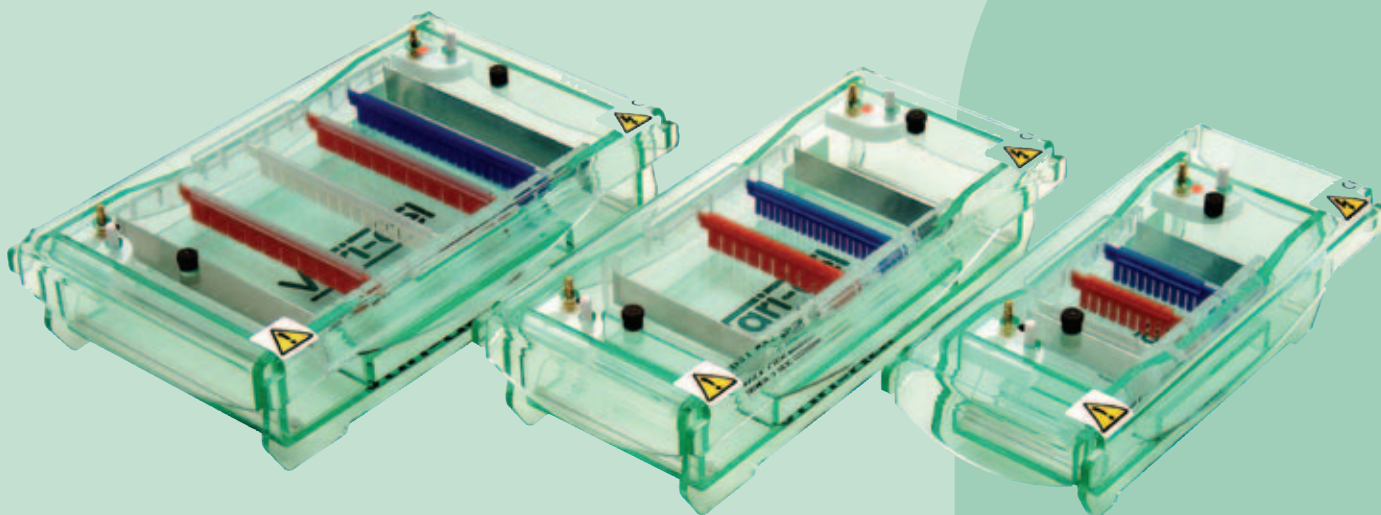

The Vari-gel Range

The Vari-gel Range is designed to provide a low cost electrophoresis solution that not only offers several gel tray options within one tank but also retains the quality and features of the popular Green Range horizontal units.

The Vari-gel Range is available in MINI, MIDI and MAXI formats, each format determined by the width and number of gel-casting trays.

ORDERING INFORMATION

Complete System

MINI
A 7cm wide Vari-gel unit, which includes two gel-casting trays:
7 x 7cm and 7 x 10cm (W x L)

Part No.
SVG-SYS

MIDI
A 10cm wide Vari-gel unit, which includes three gel-casting trays:
10 x 7cm, 10 x 10cm and 10 x 15cm (W x L)

TVG-SYS

MAXI
A 15cm wide Vari-gel unit, which includes four gel-casting trays:
15 x 7cm, 15 x 10cm, 15 x 15cm and 15 x 20cm (W x L)

VG-SYS

Each unit is fabricated from 5mm acrylic sheet as standard and comprises two combs, buffer recirculation ports, gel trays with aluminium casting gates and platinum electrodes 0.2mm in diameter.

BENEFITS INCLUDE

- Robust acrylic tank construction
- Safety lid with integral power leads
- Shrouded 4mm power output connectors universally compatible with modern-day low to medium voltage power supplies
- Long-life, 99.99 % pure platinum electrodes
- Gold-plated terminals with corrosion-free stainless steel washers
- Durable high-impact polystyrene (HIPS) combs
- UV-transparent acrylic gel-casting trays
- Offset asymmetric electrodes
- Colour-coded combs corresponding to 1, 1.5 and 2mm thicknesses

Horizontal Gel Units

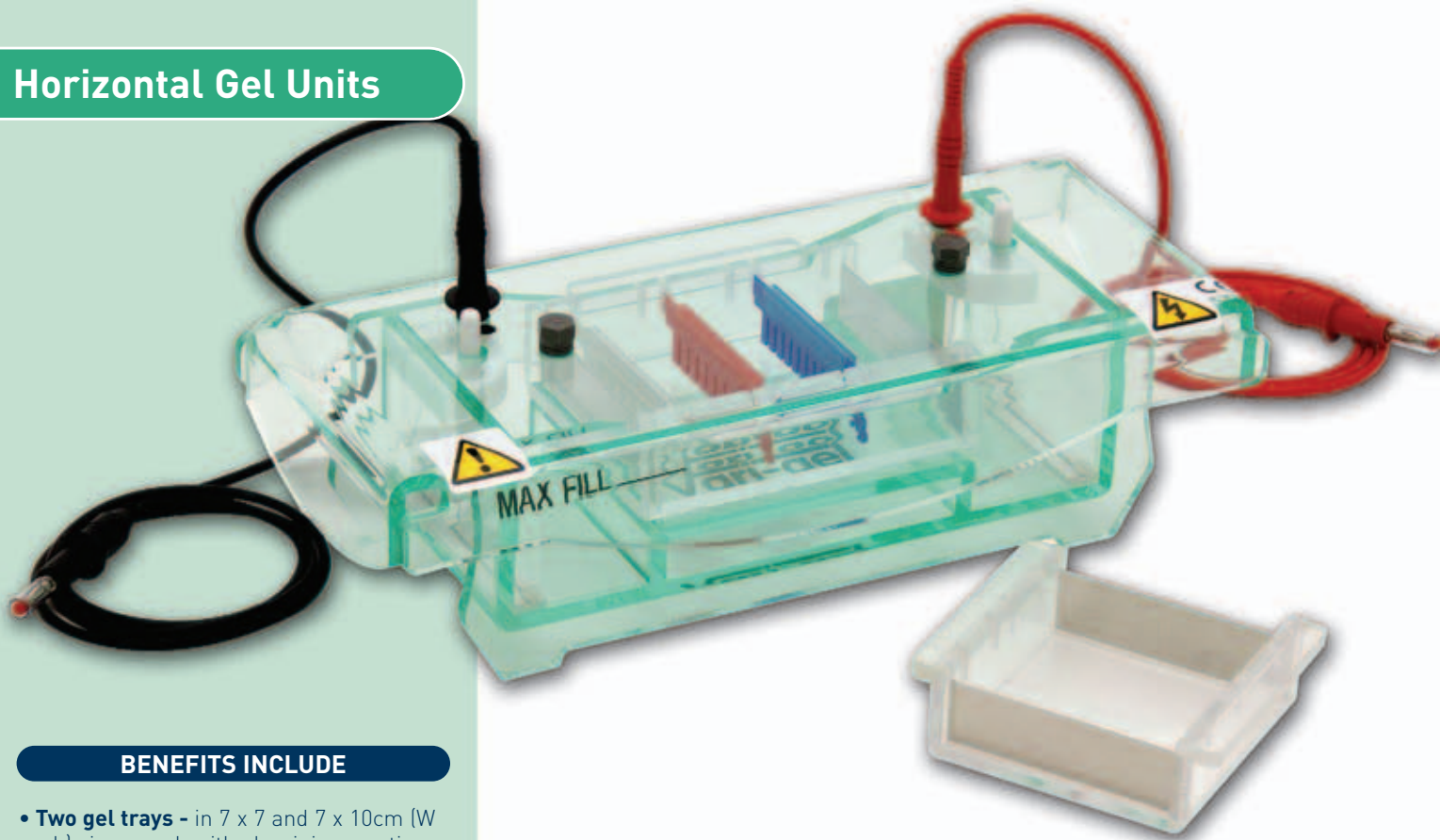

BENEFITS INCLUDE

- **Two gel trays** - in 7 x 7 and 7 x 10cm (W x L) sizes, each with aluminium casting gates
- **Multiple comb slots** - regularly positioned along the gel tray and corresponding to each comb thickness - allow the user to adjust the sample migration distance according to their own personal preference
- **Colour-coded combs** - 1, 1.5 and 2mm thick
- **Buffer recirculation ports** - may be connected to a peristaltic pump for buffer recirculation during electrophoresis to maintain buffer pH and prevent ionic gradient formation
- **Coloured loading strips** - for easy well detection when loading
- **Compact tank** - reduces the buffer volume required to cover the gel, providing greater control over the voltage gradient and run-time
- **UV-transparent acrylic casting tray** - allows the user to image the gel without risk of damage due to handling
- **Scie-Plas Super-Seals** - available as an accessory for flexible casting

SVG-SYS Vari-gel MINI System

The SVG-SYS Vari-gel mini system is ideal for standard preparatory and analytical electrophoresis techniques.

SVG-SYS CASTING OPTIONS

SVG-GT-ALCG - aluminium casting gates at each end of the gel tray guarantee leak-free casting when they are first lined with agarose



SVG-SS - 7cm long Scie-Plas Super-Seals offer total versatility in casting, allowing the gel length to be tailored to each user's personal requirements

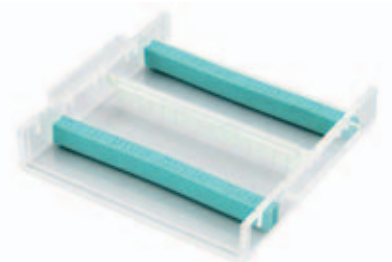

 **CASTING TIP** Regardless of the casting method, ensure leak-free casting by lining the casting unit with agarose and allowing it to set before pouring the remainder of the hand-hot agarose mixture i.e. at approx. 50°C



ORDERING INFORMATION

Complete System

A complete 7cm wide Vari-gel system with 2 removable gel trays, 7 x 7 and 7 x 10cm (W x L); 2 x 1mm, 15-sample combs; aluminium casting gates and coloured loading strips

Part No.

SVG-SYS

Replacement Parts & Accessories

1 x gel casting tray, 7 x 7cm, including aluminium casting gates	SVG-GT-7
1 x gel casting tray, 7 x 10cm, including aluminium casting gates	SVG-GT-10
2 x buffer recirculation ports	HU-BRP
2 x aluminium casting gates	SVG-GT-ALCG
2 x Scie-Plas Super-Seals	SVG-SS
6 x coloured loading strips	SVG-CS
1 x gel scoop	SVG-GS
2 x 0.2mm thick, platinum electrode wire	PT-0.2
2 x 1 metre power leads with shrouded 4mm power output connectors	CABLE-4

SVG-SYS Combs

Part No.	Thickness (mm)	Sample Throughput	Tooth Width (mm)	Max. Spacing (mm)	Sample Volume in a 5mm Deep Well (µl)
SVG-C1-8	1	8	5.5	2	27
SVG-C1-12	1	12	3	2	15
SVG-C1-15	1	15	2	2	10
*SVG-C1-16MC	1	16	1.75	2	8
SVG-C1.5-8	1.5	8	5.5	2	40
SVG-C1.5-12	1.5	12	3	2	22
SVG-C1.5-15	1.5	15	2	2	15
*SVG-C1.5-16MC	1.5	16	1.75	2	12
SVG-C2-8	2	8	5.5	2	54
SVG-C2-12	2	12	3	2	30
SVG-C2-15	2	15	2	2	20
*SVG-C2-16MC	2	16	1.75	2	16

*Multi-channel pipette compatible

TRAY OPTIONS

Part No.	Tray 1 SVG-GT-7	Tray 2 SVG-GT-10
Gel Size (W x L)	7 x 7cm	7 x 10cm
Combs Slots	4 (2 slots for 1mm combs; 2 slots for 1.5 and 2mm combs)	6 (3 slots for 1mm combs; 3 slots for 1.5 and 2mm combs)
Migration Distance Between Comb Slots	2.8cm	3.0cm
Maximum Sample Capacity	32	48

*each tray includes 2 x aluminium casting gates

TECHNICAL SPECIFICATION

Unit Dimensions (W x L x H)	25 x 11 x 7cm
Gel Size (W x L)	see Trays
Buffer Volume	350ml
Buffer Recirculation Ports	2
Maximum Sample Capacity	48
Combs	2
Comb Thickness	1, 1.5 or 2mm
Comb Throughput	8 to 20 samples
Recommended Running Voltage	75 to 100V
Power Output Connectors (diameter)	Shrouded, 4mm
Recommended Power Supply	Consort EV222

DO YOU NEED...?

AGAROSE	SEE PAGE 118
A GEL LEVELING TABLE	SEE PAGE 34
A POWER SUPPLY	SEE PAGES 91-92
SUPER-SEALS™	SEE PAGE 33

Migration distances between comb slots, for either 1mm or 1.5 and 2mm combs, in the SVG-SYS gel-casting trays

SVG-GT-7

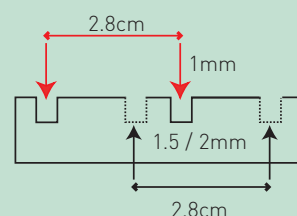

SVG-GT-10

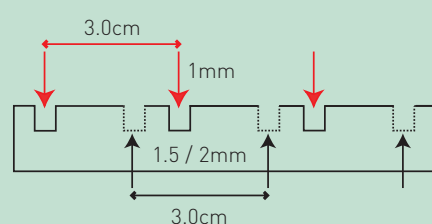

Horizontal Gel Units

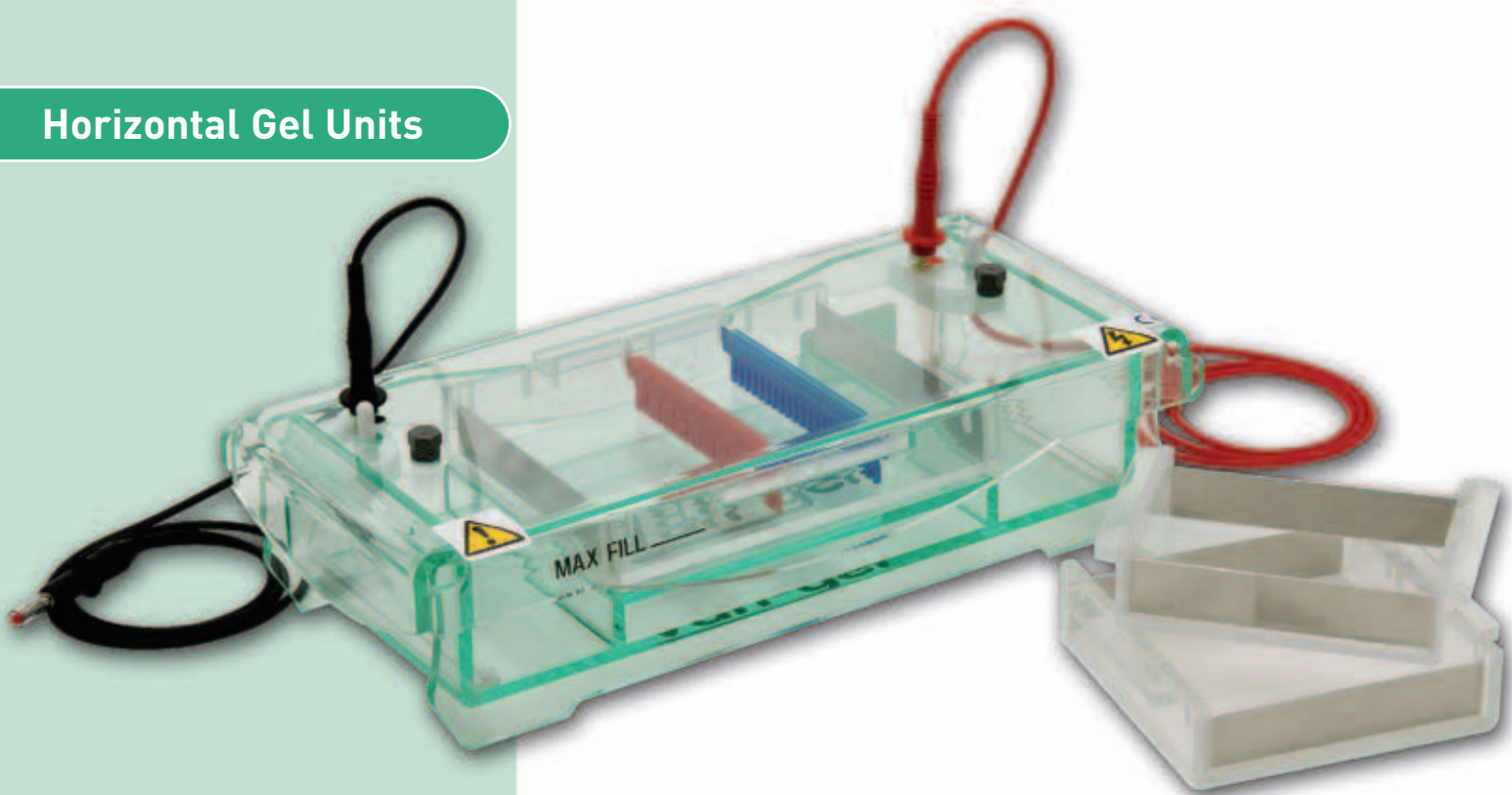

BENEFITS INCLUDE

- **Three gel trays** - in 10 x 7, 10 x 10 and 10 x 15cm (W x L) sizes, each with aluminium casting gates
- **Multiple comb slots** - regularly positioned along the gel tray and corresponding to each comb thickness - allow the user to adjust the sample migration distance according to their own personal preference
- **Colour-coded combs** - 1, 1.5 and 2mm thick
- **Buffer recirculation ports** - may be connected to a peristaltic pump for buffer recirculation during electrophoresis to maintain buffer pH and prevent ionic gradient formation
- **Coloured loading strips** - for easy well detection when loading
- **Compact tank** - reduces the buffer volume required to cover the gel, providing greater control over the voltage gradient and run-time
- **UV-transparent acrylic casting tray** - allows the user to image the gel without risk of damage due to handling
- **Scie-Plas Super-Seals** - available as an accessory for flexible casting



TVG-SYS Vari-gel MIDI System

The TVG-SYS Vari-gel midi system is ideal for standard preparatory and analytical electrophoresis techniques.

Migration distances between comb slots, for either 1mm or 1.5 and 2mm combs, in the TVG-SYS gel-casting trays

TVG-GT-7

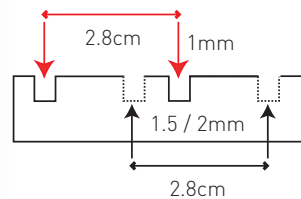

TVG-GT-10

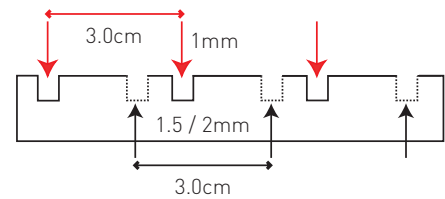

TVG-GT-15

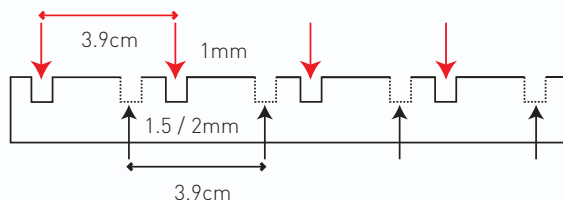

TRAY OPTIONS

Part No.	Tray 1 TVG-GT-7	Tray 2 TVG-GT-10	Tray 3 TVG-GT-15
Gel Size (W x L)	10 x 7cm	10 x 10cm	10 x 15cm
Combs Slots	4 (2 slots for 1mm combs; 2 slots for 1.5 and 2mm combs)	6 (3 slots for 1mm combs; 3 slots for 1.5 and 2mm combs)	8 (4 slots for 1mm combs; 4 slots for 1.5 and 2mm combs)
Migration Distance Between Comb Slots	2.8cm	3.0cm	3.9cm
Maximum Sample Capacity	40	60	80

*each tray includes 2 x aluminium casting gates

ORDERING INFORMATION

Complete System

A complete 10cm wide Vari-gel system with 3 removable gel trays, 10 x 7, 10 x 10 and 10 x 15cm (W x L); 2 x 1mm, 15-sample combs; aluminium casting gates and coloured loading strips

Part No.

TVG-SYS

Replacement Parts & Accessories

1 x gel casting tray, 10 x 7cm, including aluminium casting gates	TVG-GT-7
1 x gel casting tray, 10 x 10cm, including aluminium casting gates	TVG-GT-10
1 x gel casting tray, 10 x 15cm, including aluminium casting gates	TVG-GT-15
2 x buffer recirculation ports	HU-BRP
2 x aluminium casting gates	TVG-GT-ALCG
2 x Scie-Plas Super-Seals	TVG-SS
10 x coloured loading strips	TVG-CS
1 x gel scoop	TVG-GS
2 x 0.2mm thick, platinum electrode wire	PT-0.2
2 x 1 metre power leads with shrouded 4mm power output connectors	CABLE-4

TVG-SYS Combs

Part No.	Thickness (mm)	Sample Throughput	Tooth Width (mm)	Max. Spacing (mm)	Sample Volume in a 5mm Deep Well (µl)
TVG-C1-8	1	8	9.25	2	45
TVG-C1-12	1	12	5.5	2	25
TVG-C1-15	1	15	4	2	20
*TVG-C1-16MC	1	16	3.62	2	15
TVG-C1-20	1	20	2.5	2	10
TVG-C1.5-8	1.5	8	9.25	2	65
TVG-C1.5-12	1.5	12	5.5	2	35
TVG-C1.5-15	1.5	15	4	2	30
*TVG-C1.5-16MC	1.5	16	3.62	2	20
TVG-C1.5-20	1.5	20	2.5	2	15
TVG-C2-8	2	8	9.25	2	90
TVG-C2-12	2	12	5.5	2	50
TVG-C2-15	2	15	4	2	40
*TVG-C2-16MC	2	16	3.62	2	30
TVG-C2-20	2	20	2.5	2	20

*Multi-channel pipette compatible



TECHNICAL TIP | Caution:

Ethidium bromide is a known mutagen. Always wear gloves when handling. Wear UV safety goggles and protect skin when using any UV light source.

TECHNICAL SPECIFICATION

Unit Dimensions (W x L x H)	31.5 x 14.5 x 7cm
Gel Size (W x L)	see Trays
Buffer Volume	650ml
Buffer Recirculation Ports	2
Maximum Sample Capacity	80
Combs	2
Comb Thickness	1, 1.5 or 2mm
Comb Throughput	8 to 20 samples
Recommended Running Voltage	75 to 125V
Power Output Connectors (diameter)	Shrouded, 4mm
Recommended Power Supply	Consort EV222

TVG-SYS CASTING OPTIONS

TVG-GT-ALCG - aluminium casting gates at each end of the gel tray guarantee leak-free casting when they are first lined with agarose



TVG-SS - 10cm long Scie-Plas Super-Seals offer total versatility in casting, allowing the gel length to be tailored to each user's personal requirements



Horizontal Gel Units

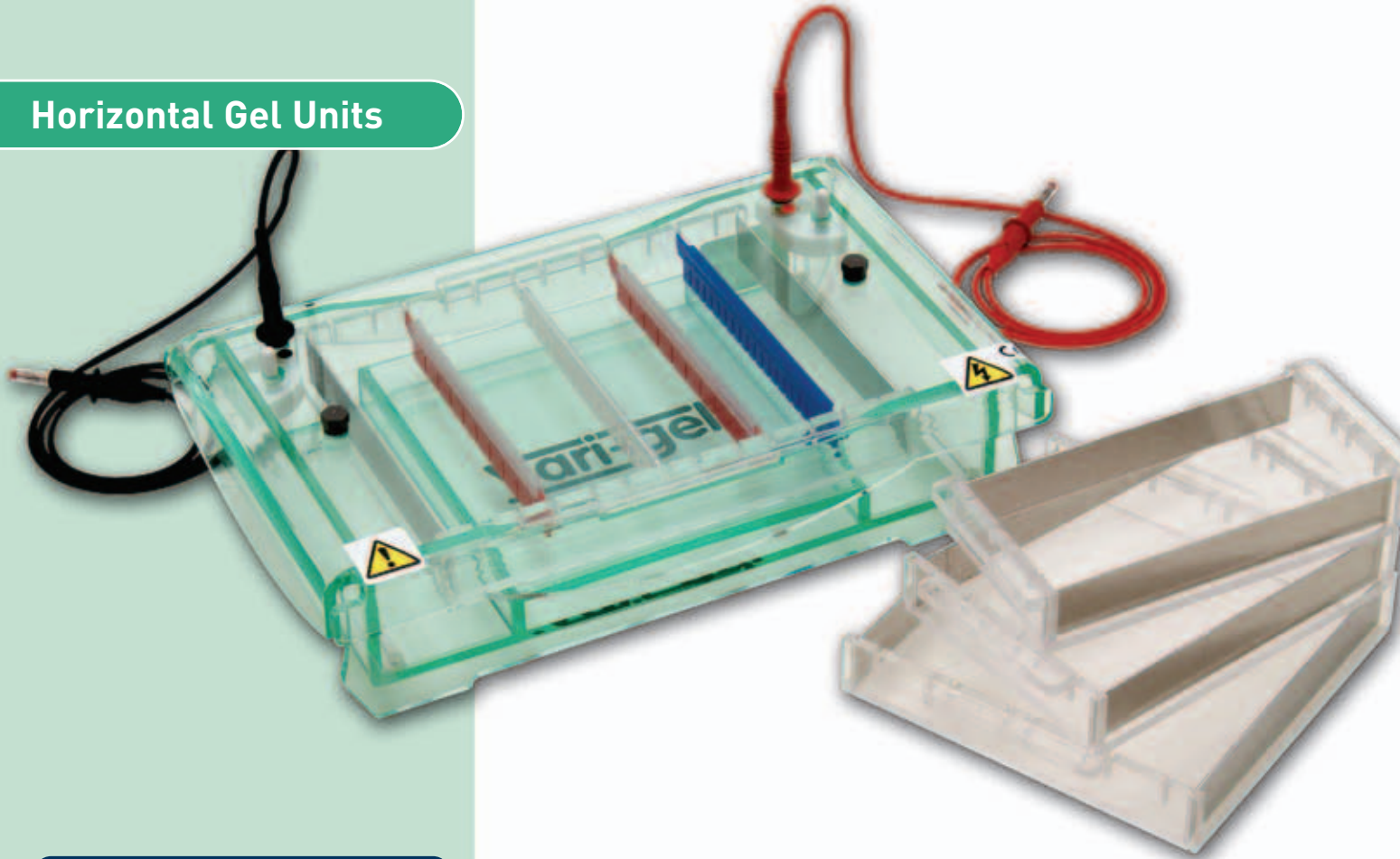

BENEFITS INCLUDE

- **Four gel trays** - in 15 x 7, 15 x 10, 15 x 15 and 15 x 20cm (W x L) sizes, each with aluminium casting gates
- **Multiple comb slots** - regularly positioned along the gel tray and corresponding to each comb thickness - allow the user to adjust the sample migration distance according to their own personal preference
- **Colour-coded combs** - 1, 1.5 and 2mm thick
- **Buffer recirculation ports** - may be connected to a peristaltic pump for buffer recirculation during electrophoresis to maintain buffer pH and prevent ionic gradient formation
- **Coloured loading strips** - for easy well detection when loading
- **Compact tank** - reduces the buffer volume required to cover the gel, providing greater control over the voltage gradient and run-time
- **UV-transparent acrylic casting tray** - allows the user to image the gel without risk of damage due to handling
- **Scie-Plas Super-Seals** - available as an accessory for flexible casting

VG-SYS Vari-gel MAXI System

The VG-SYS Vari-gel maxi system is ideal for standard preparatory and analytical electrophoresis techniques.

Migration distances between comb slots, for either 1mm or 1.5 and 2mm combs, in the VG-SYS gel-casting trays

VG-GT-7

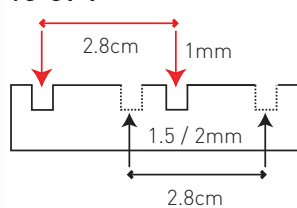

VG-GT-10

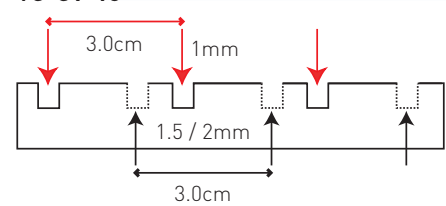

VG-GT-15

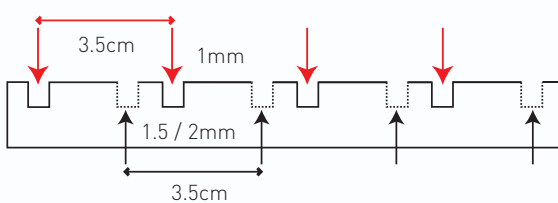

VG-GT-20

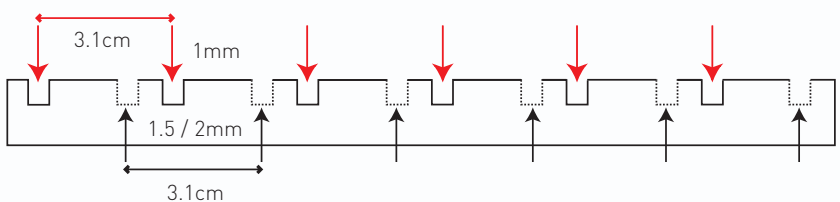

ORDERING INFORMATION

Complete System

A complete 15cm wide Vari-gel system with 4 removable gel trays, 15 x 7, 15 x 10, 15 x 15 and 15 x 20cm (W x L); 2 x 1mm, 15-sample combs; aluminium casting gates and coloured loading strips

Part No.

VG-SYS

Replacement Parts & Accessories

1 x gel casting tray, 15 x 7cm, including aluminium casting gates	VG-GT-7
1 x gel casting tray, 15 x 10cm, including aluminium casting gates	VG-GT-10
1 x gel casting tray, 15 x 15cm, including aluminium casting gates	VG-GT-15
1 x gel casting tray, 15 x 20cm, including aluminium casting gates	VG-GT-20
2 x buffer recirculation ports	HU-BRP
2 x aluminium casting gates	VG-GT-ALCG
2 x Scie-Plas Super-Seals	VG-SS
12 x coloured loading strips	VG-CS
1 x gel scoop	VG-GS
2 x 0.2mm thick, platinum electrode wire	PT-0.2
2 x 1 metre power leads with shrouded 4mm power output connectors	CABLE-4

VG-SYS Combs

Part No.	Thickness (mm)	Sample Throughput	Tooth Width (mm)	Max. Spacing (mm)	Sample Volume in a 5mm Deep Well (µl)
VG-C1-10	1	10	12.8	2	64
*VG-C1-16MC	1	16	6.4	2	32
VG-C1-20	1	20	5.9	2	29
VG-C1-25	1	25	3.5	2	17
*VG-C1-30MC	1	30	2.5	2	12
VG-C1.5-10	1.5	10	12.8	2	96
*VG-C1.5-16MC	1.5	16	6.4	2	48
VG-C1.5-20	1.5	20	5.9	2	43
VG-C1.5-25	1.5	25	3.5	2	25
*VG-C1.5-30MC	1.5	30	2.5	2	18
VG-C2-10	2	10	12.8	2	128
VG-C2-16MC	2	16	6.4	2	64
VG-C2-20	2	20	5.9	2	58
VG-C2-25	2	25	3.5	2	34
*VG-C2-30MC	2	30	2.5	2	24

*Multi-channel pipette compatible

TRAY OPTIONS

Part No.	Tray 1 VG-GT-7	Tray 2 VG-GT-10	Tray 3 VG-GT-15	Tray 4 VG-GT-20
Gel Size (W x L)	15 x 7cm	15 x 10cm	15 x 15cm	15 x 20cm
Combs Slots	4 (2 slots for 1mm combs; 2 slots for 1.5 and 2mm combs)	6 (3 slots for 1mm combs; 3 slots for 1.5 and 2mm combs)	8 (4 slots for 1mm combs; 4 slots for 1.5 and 2mm combs)	12 (6 slots for 1mm combs; 6 slots for 1.5 and 2mm combs)
Migration Distance Between Comb Slots	2.8cm	3.0cm	3.5cm	3.1cm
Maximum Sample Capacity	60	90	120	180

*each tray includes 2 x aluminium casting gates

TECHNICAL SPECIFICATION

Unit Dimensions (W x L x H)	31.5 x 19 x 7cm
Gel Size (W x L)	see Trays
Buffer Volume	950ml
Buffer Recirculation Ports	2
Maximum Sample Capacity	180
Combs	2
Comb Thickness	1, 1.5 or 2mm
Comb Throughput	10 to 30 samples
Recommended Running Voltage	75 to 150V
Power Output Connectors (diameter)	Shrouded, 4mm
Recommended Power Supply	Consort EV243



**ELECTROPHORESIS
CHEMICALS
SEE PAGES 117-123**

Horizontal Gel Units

BENEFITS INCLUDE

- **Single gel tray with fluorescent numbering** - allows up to 96 SSPs to be loaded directly onto the tray, so that each SSP is automatically numbered for gel photography, simplifying post-electrophoretic analysis
- **6 comb slots** - positioned at 25mm intervals along the gel tray allow SSPs to be separated in less than 30 minutes using the appropriate running conditions (see Technical Specification)
- **Six 17-sample combs** - with each marker lane positioned centrally - enables SSPs to be loaded onto the gel quickly, 8 at a time by multi-channel pipette
- **Compact tank** - reduces the buffer volume required to cover the gel, providing greater control over the voltage gradient and run-time
- **Robust acrylic casting tray** - UV-transparent for visualisation with fluorescent numbering for SNP recognition and traceability
- **Ideal for use** - either with 96-well microtitre plates or 96-well blocks
- **Buffer recirculation ports** - may be connected to a peristaltic pump for buffer recirculation during electrophoresis

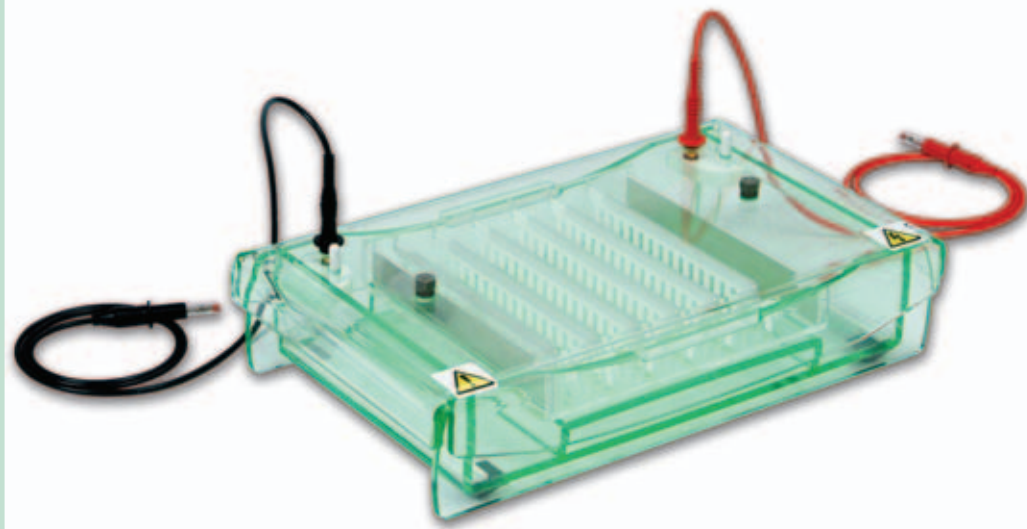

VG-FAST96 High Throughput Vari-gel MAXI System

The VG-FAST96 high throughput Vari-gel maxi system is the latest addition to the Scie-Plas Vari-gel product range, providing a swift and simple solution for the screening and analysis of up to 96 single-strand polymorphisms (SSP) following PCR® amplification. Under the appropriate running conditions, SSPs, 50 to 1000 base pairs in size, can be separated in less than 30 minutes.

ROBUST ACRYLIC CASTING TRAY

Fluorescent visualisation of the lanes for the markers and samples 1-96 on the VG-FAST-GT high throughput gel-casting tray, using the Scie-Plas Vision gel documentation system.



ORDERING INFORMATION

Complete System

A complete 16cm wide high throughput Vari-gel system with 1 removable UV-transparent and UV-fluorescent gel tray, 16 x 17.5cm (W x L); 6 x 1mm, 17-sample combs and aluminium casting gates

Part No.

VG-FAST96

Replacement Parts & Accessories

1 x removable UV-transparent and UV-fluorescent gel casting tray, 16 x 17.5cm, including aluminium casting gates

VG-FAST-GT

2 x aluminium casting gates

VG-FAST-ALCG

2 x buffer recirculation ports

HU-BRP

1 x gel scoop

VG-FAST-GS

2 x 0.2mm thick, platinum electrode wire

PT-0.2

2 x 1 metre power leads with

shrouded 4mm power output connectors

CABLE-4

VG-FAST 96 Combs

Part No.	Thickness (mm)	Sample Throughput	Tooth Width (mm)	Max. Spacing (mm)	Sample Volume in a 5mm Deep Well (µl)
VG-FAST-C1-17MC	1	17	5	3.5	25

*Multi-channel pipette compatible

TECHNICAL SPECIFICATION

Unit Dimensions (W x L x H)	33 x 19.5 x 7.5cm
Gel Size (W x L)	16 x 17.5cm
Buffer Volume	950ml
Buffer Recirculation Ports	2
Maximum Sample Capacity	96 + 8
Combs	6
Comb Thickness	1mm
Comb Throughput	17 samples: 2 x 8 loaded by multi-channel pipette; 1 x marker
Comb Slots	6
Migration Distance Between Comb Slots	2.5cm
Recommended Running Voltage	100 to 150V
Power Output Connectors (diameter)	Shrouded, 4mm
Recommended Power Supply	Consort EV243



TECHNICAL TIP | Photography:

If the gel needs to be photographed, thin gels (2 to 3mm) with low-percentage agarose are better than thick or high-percentage gels. The latter produce increased opacity and autofluorescence.

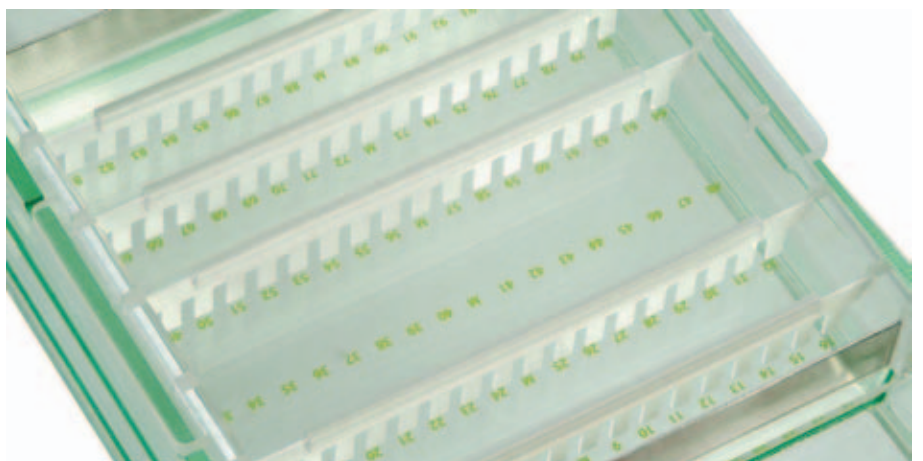

Horizontal Gel Units

Today's laboratory scientists can take advantage of many gel-casting methods, ranging from the traditional, homemade solution of sealing the ends of the gel tray with tape to flexible gel casting, at any position within the tray, with Scie-Plas Super-Seals™.

SCIE-PLAS CASTING OPTIONS

Plastic casting gates

- Available with the HB-SET and H1-SET units only
- Slot into preformed grooves within the gel tank

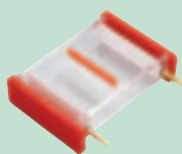

Aluminium casting gates

- Available with the SVG-SYS, TVG-SYS and VG-SYS units only
- Slot into preformed grooves within the gel-casting tray

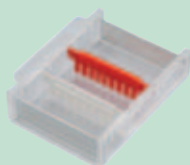

Silicone gasket

- Available with the HU6, HU10 and HU13 units only
- Slot into preformed grooves at each end of the gel-casting tray, which is then turned at 90° to the direction of electrophoresis to form a leak-free seal against the walls of the gel tank



Casting gates with integral silicone seals

- Available with the HU15, HU20, HU25, CHU20 and CHU25 units
- By slotting into preformed grooves, casting gates with integral silicone seals effectively seal the tray, provided the silicone gasket faces outwards as shown

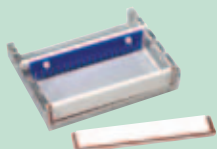

Silicone casting gates

- Available for the HU6, HU10 and HU13 units
- Slot into grooves at each end of the casting tray to form a leak-free seal

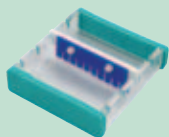

External casting units

- Available for the HU6, HU10 and HU13 units for simultaneous casting of up to 3 gels
- Silicone gaskets, seated in the groove of each casting tray, form a leak-free seal against the walls of the casting unit



Horizontal Gel Casting Products

Scie-Plas currently provides a variety of gel-casting options with its horizontal units, all of which will ensure reliable casting.



Always line the casting gates with a small amount of agarose, allowing it to set before pouring the remainder of the cooled, hand-hot agarose mixture i.e. at approx. 50°C.



ORDERING INFORMATION

Description

2 x plastic casting gates for the HB-SET
2 x plastic casting gates for the H1-SET

Part No.

HB-CG
H1-CG

N.B. Casting only performed directly in the unit, without casting trays

Description

2 x aluminium casting gates for the SVG-SYS
2 x aluminium casting gates for the TVG-SYS
2 x aluminium casting gates for the VG-SYS

Part No.

SVG-GT-ALCG
TVG-GT-ALCG
VG-GT-ALCG

N.B. For individual gel trays with aluminium casting gates, please see the SVG-SYS, TVG-SYS and VG-SYS product literature.

Description

1 x silicone gasket for the HU6, HU10 & HU13, 1 metre HU-SG

Part No.

N.B. For individual gel trays with silicone gaskets, please see the HU6, HU10 and HU13 product literature.

Description

2 x casting gates with integral silicone seals for HU15
2 x casting gates with integral silicone seals for CHU20 & HU20
2 x casting gates with integral silicone seals for CHU25 & HU25

Part No.

HU15-CG
HU20-CG
HU25-CG

N.B. For individual gel trays with casting gates with integral silicone seals, please see the respective product literature for each unit

Description

2 x silicone casting gates for HU6
2 x silicone casting gates for HU10
2 x silicone casting gates for HU13

Part No.

HU6-SCG
HU10-SCG
HU13-SCG

Description

1 x external casting unit for 3 gel trays, HU6
1 x external casting unit for 3 gel trays, HU10
1 x external casting unit for 3 gel trays, HU13

Part No.

HU6-CU
HU10-CU
HU13-CU



Scie-Plas Super-Seals™

Throw away all those gel gates and casting units and use our specifically designed and formulated silicone seals, which can be placed anywhere within the casting tray.

Scie-Plas Super-Seals™ offer the ultimate solution in flexible, leak-free gel casting.

BENEFITS INCLUDE

- **Cost-effective and completely versatile** - can be positioned anywhere within the casting tray, allowing the user to generate shorter gel lengths without the need for smaller casting trays
- **Reliable, leak-free casting** - is a certainty, provided the seals are first inserted correctly within the tray and then lined with agarose before pouring the remainder of the cooled gel mixture
- **Still effective - even with boiling agarose** - as long as the seals are inserted properly and lined with agarose
- **Available - for all Scie-Plas horizontal gel-casting trays**

ORDERING INFORMATION

Description	Approximate Dimensions (L x W x H)	Part No.
Green Range		
2 x 6cm long Super-Seals for the HU6	6 x 1 x 1cm	HU6-SS
2 x 10cm long Super-Seals for the HU10	10 x 1.1 x 1cm	HU10-SS
2 x 13cm long Super-Seals for the HU13	13 x 1.1 x 1.4cm	HU13-SS
2 x 15cm long Super-Seals for the HU15	15 x 1.1 x 1.4cm	HU15-SS
2 x 20cm long Super-Seals for the CHU20 & HU20	20 x 2 x 1.2cm	HU20-SS
2 x 25cm long Super-Seals for the CHU25 & HU25	25 x 2 x 1.2cm	HU25-SS
Vari-gel Range		
2 x 7cm long Super-Seals for the SVG-SYS	7 x 1 x 1cm	SVG-SS
2 x 10cm long Super-Seals for the TVG-SYS	10 x 1.1 x 1cm	TVG-SS
2 x 15cm long Super-Seals for the VG-SYS	15 x 1.1 x 1.4cm	VG-SS

How to cast with Scie-Plas Super-Seals™

1. Place each Scie-Plas Super-Seal™ at the desired position within the gel tray, applying an even pressure along its length



2. Line each Scie-Plas Super-Seal™ with a few millilitres of melted agarose, allowing it to cool and then set to form a leak-proof seal



3. Pour the remainder of the agarose mixture - preferably cooled to hand-heat (i.e. at 50°C) for completely reproducible results - into the gel tray



4. Insert combs and allow the gel to set for at least 30 minutes before removing the comb and loading the samples

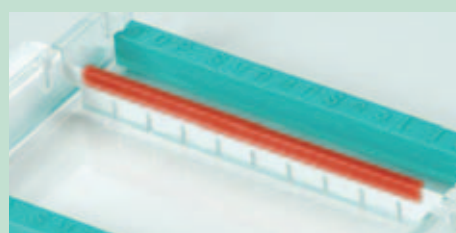

Tip: Scie-Plas recommends 0.67ml of agarose per cm² of gel tray area for a minimum 5mm thick gel - e.g. 150ml of melted agarose for a 15 x 15cm gel tray, as shown (Volume ml = W x L x 0.67).

Horizontal Gel Units

BENEFITS INCLUDE

- **Large platform** - 30 x 20cm platform area accommodates all Scie-Plas gel-casting trays from the HU6 to HU25 units
- **Easy to use** - large, thumb-wheel leveling feet at each corner facilitate easy adjustment of the platform
- **Leveling bubble** - in the centre of the platform ensures even gel-pouring

BENEFITS INCLUDE

- **In 3 different colours** - for easy visualisation of samples mixed with different dyes such as bromophenol and xylene cyanol
- **Adhesive** - each colour strip has an adhesive backing allowing it to be easily affixed and removed with each application
- **Available** - for all horizontal units

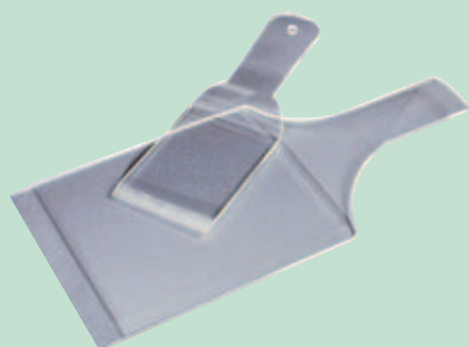

Gel Leveling Table

Allows advance pouring of gels of uniform thickness.

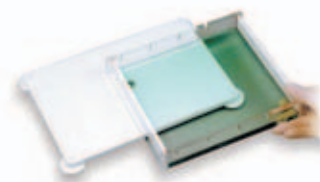

ORDERING INFORMATION

Description	Part No.
1 x gel leveling table, 30 x 20cm	GLT-3020

Coloured Strips

Aid sample visualisation during gel loading.

ORDERING INFORMATION

Description	Part No.
Green Range	
12 x coloured loading strips for HU6	HU6-CS
12 x coloured loading strips for HU13	HU13-CS
12 x coloured loading strips for HU15	HU15-CS
12 x coloured loading strips for HU20 and CHU20	HU20-CS
36 x coloured loading strips for HU25 and CHU25	HU25-CS
Vari-gel Range	
6 x coloured loading strips for SVG-SYS	SVG-CS
10 x coloured loading strips for TVG-SYS	TVG-CS
12 x coloured loading strips for VG-SYS	VG-CS

Gel Scoops

Ideal for safe and easy transfer of gels from staining or destaining tanks to a transilluminator or similar surface.

ORDERING INFORMATION

Description	Scoop Area (W x L)	Part No.
Green Range		
1 x gel scoop for HU6	6 x 8.5cm	HU6-GS
1 x gel scoop for HU10	10 x 14.5cm	HU10-GS
1 x gel scoop for HU13	13 x 15cm	HU13-GS
1 x gel scoop for HU15	15 x 15cm	HU15-GS
1 x gel scoop for HU20 and CHU20	20 x 25cm	HU20-GS
1 x gel scoop for HU25 and CHU25	25 x 32.5cm	HU25-GS
Vari-gel Range		
1 x gel scoop for SVG-SYS	7 x 10cm	SVG-GS
1 x gel scoop for TVG-SYS	10 x 15cm	TVG-GS
1 x gel scoop for VG-SYS	15 x 20cm	VG-GS

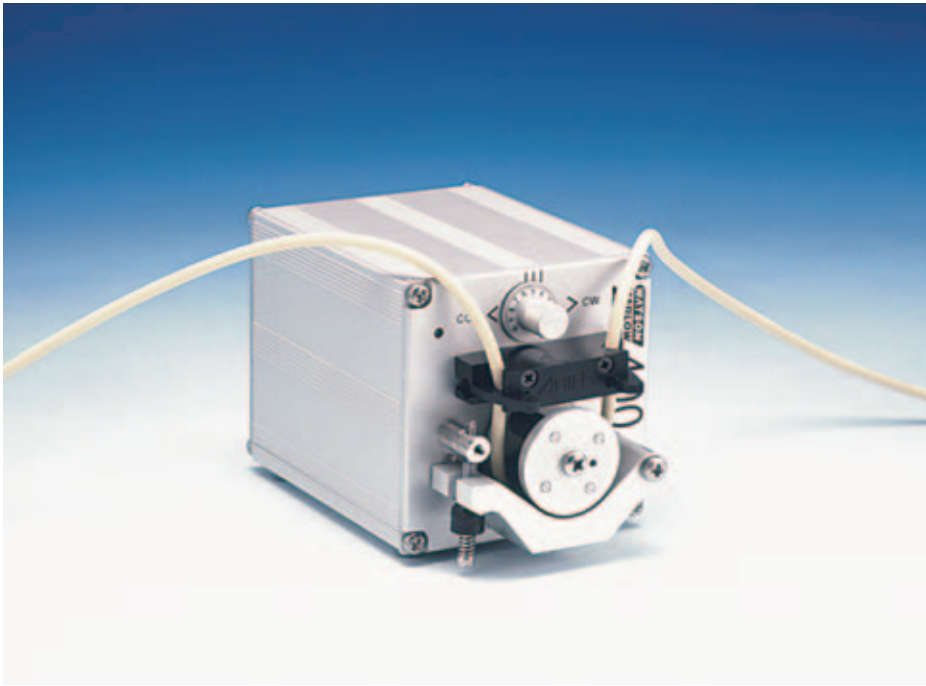

Buffer Recirculation Pump

The 401/D1 auto/manual control ultra compact buffer recirculation pump is ideal for those users wishing to maintain buffer recirculation during horizontal gel electrophoresis. The pump can be connected to the HU13, HU15, CHU20, HU20, CHU25, HU25, SVG-SYS, TVG-SYS, VG-SYS and COMET units through buffer recirculation ports located within the lid of each unit.

ORDERING INFORMATION

Description	Rpm	Part No.
401U/D1 (15VAC) 220-240V 50/60Hz 1ph single channel standard tubing pump	20-200	040.1S1D.020
Replacement Parts & Accessories		
1 metre platinum silicone tube, bore 4.0mm / wall 1.6mm		913.A040.016

BENEFITS INCLUDE

- **High flow rate** - single channel flows up to 0.01 to 120ml/min
- **Highly compact** - with single control potentiometer for direction, speed and start/stop
- **Analogue speed control and remote switching via a 15D connector**
- **Reversible** - for easy fluid recovery
- **Continuous tubing**
- **Adjustable occlusion** (pressure)

TECHNICAL SPECIFICATION

Weight	1.0kg
Dimensions (W x H x D)	80 x 84 x 133mm
Operational Temperature Range	5°C to 40°C
Noise	<70dBA at 1m
Control ratio	10:1
Standards	CE, BS0800, IEC335-1, EN60529 (IP21)
Supply	15 Vac from mains transformer

Materials of Construction

Drive	Extruded anodised aluminium
Front Support	Anodised aluminium plate
Pumphead Track	Extruded anodised aluminium
Pumphead Rollers	Acetal
Pumphead Rotor	Aluminium

BENEFITS INCLUDE

- **Developed in collaboration with end-users** - as with all our gel electrophoresis units, the CA-SYS and units have been designed in close consultation with end-users: in this case NHS biomedical scientists who routinely use cellulose acetate electrophoresis to screen for mucopolysaccharide (MPS) disorders in children
- **Active tank area:** -
CA-SYS - 24.5 x 26cm (W x L) easily accommodates larger 145 x 192mm membranes, or up to three standard 78 x 75/150mm membranes simultaneously
- **Adjustable bridge prices** - can be located anywhere within the tank to support cellulose acetate membranes or horizontal precast gels
- **Clamping bars within clip holders** - hold the cellulose acetate membrane or paper wick gently in position
- **Asymmetric offset electrodes** - ensure that the membrane is run in the correct polar orientation
- **Transparent lid** - allows electrophoresis to be monitored as it happens as well as maintaining uniform atmospheric conditions
- **A central partition** - separates the buffer and lends additional support to longer membranes and precast gels
- **Membranes available** - in small, standard and large formats



CA-SYS Cellulose Acetate System

The CA-SYS cellulose acetate system has been designed in close collaboration with the UK National Health Service (NHS) to run cellulose acetate membranes and wick-based electrophoresis applications, particularly in the two-dimensional screening of inherited metabolic disorders in children.

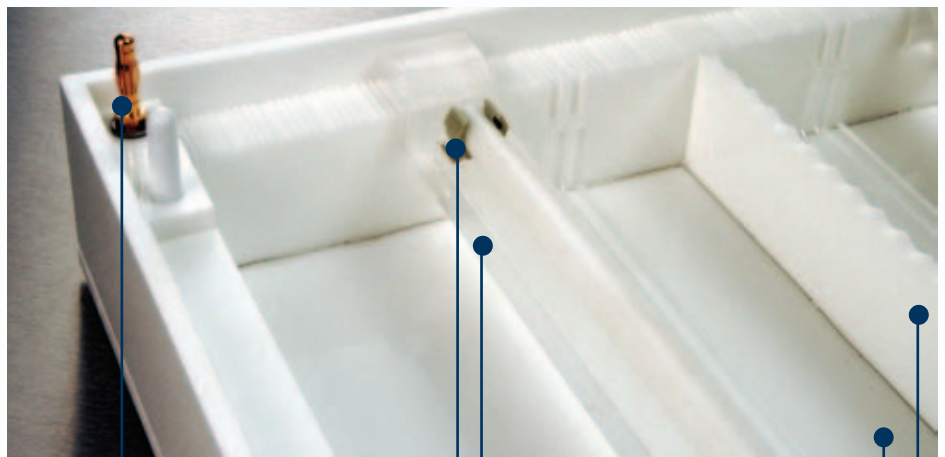

Asymmetric offset electrodes - ensure that the membrane is run in the correct polar orientation

Clamping bars within clip holders - hold the cellulose acetate membrane or paper wick gently in position

Adjustable bridge prices - can be located anywhere within the tank to support cellulose acetate membranes or horizontal precast gels

Active tank area - CA-SYS - accommodates up to **three small/standard** 78 x 75/150mm membranes or **one large** 145 x 192mm membrane

Central partition - separates the buffer and lends additional support to longer membranes and precast gels

Applications Include:

- Serum Proteins
- Lipoproteins
- Haemoglobin
- Metabolites in Urine and Spinal Fluids

TECHNICAL SPECIFICATION

CA-SYS

Unit Dimensions (W x L x H)	30 x 32 x 6.5cm
Active Tank Dimensions (W x L x H)	24.5 x 26 x 3.5cm
Recommended Buffer Volume (ml)	1200ml
Maximum Membrane Length (mm)	230mm
Recommended Power Supply	55V (10mA)
Power Output Connectors (diameter)	Shrouded, 4cm
Recommended Power Supplies	Consort EV243

ORDERING INFORMATION

CA-SYS

Complete System

Cellulose acetate system, including 30 x 32cm tank with central partition, 2 x adjustable bridge pieces with clamping bars, transparent lid and 4mm power output connectors

Part No.

CA-SYS

Replacement Parts & Accessories

2 x adjustable bridge pieces with clamping bars, 27cm in length	CA-ABS
2 x 1 metre power leads with shrouded 4mm power output connectors	CABLE-4
Platinum Wire - 2 x 0.2mm thick platinum electrode wire	PT-0.2

Membranes

	Part No.
100 x ATX-micro solid standard, small-format cellulose acetate membranes, 78 x 75mm	CA-MEM-S
50 x ATX-micro solid standard, medium-format cellulose acetate membranes, 78 x 150mm	CA-MEM-M
50 x ATX-micro solid large-format cellulose acetate membranes, 145 x 192mm	CA-MEM-L

Outline Protocol for Two-dimensional (2-D) Electrophoresis of Urinary Glycosaminoglycans - a Diagnostic Indicator of Mucopolysaccharide Disorders

Buffer 1: Pyridine: Acetic Acid: Distilled Water (10:1:89 v/v)

Buffer 2: 0.1M Barium Acetate, pH 6.0

Stain: Alcian Blue

Destain: 5% Acetic Acid (v/v)

- Spot 2 x 1µl aliquots of extracted urine sample, stained with Alcian Blue, onto a 78 x 75mm cellulose acetate membrane, previously soaked and electrophoresed in Buffer 1 for 10 minutes at 55V (7.5V/cm) using either the CA-SYS or system.
- Run the membrane at 55V for a further 75 minutes in Buffer 1.
- Remove the cellulose acetate membrane from the CA-SYS or system, allowing it to dry in a fume cupboard for 1 hour.
- Float the cellulose acetate membrane face down for 5 seconds in Buffer 2, before rotating it at 90° to its original orientation and then spotting a 0.5µl aliquot of MPS Type III urine as a positive control.
- Dry and then electrophorese the cellulose acetate membrane at 55V for 3½ hours.
- Stain the cellulose acetate membrane face down for 15 minutes, before rinsing it in water and standing it overnight in Destain.
- After destaining, rinse the cellulose acetate membrane with water and dry it flat between two sheets of filter paper.

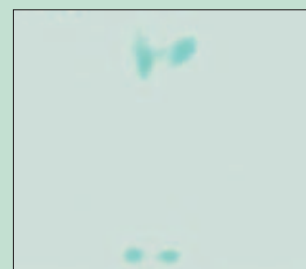

Diagnostic Analysis of Mucopolysaccharide Disorders with the CA-SYS unit. Extracted urine sample was applied to a 78 x 75mm cellulose acetate membrane, electrophoresed at 55V for 75 minutes in the first dimension, and then electrophoresed in the second dimension for a further 3½ hours at same voltage as described in the Outline Protocol. (Courtesy of the NHS)

BENEFITS INCLUDE

- **Available in 2 formats** - to accommodate 20 or 40 standard microscope slides respectively
- **Opaque ebony acrylic tank and lid** - provide ideal protection for techniques requiring light-sensitive stains or samples
- **Cooled central platform** - provides a convenient surface for slide preparation in addition to maintaining slide temperature during pre-incubation and electrophoresis (see below)
- **Cooling ports** - can be connected to an external chiller unit: to prevent overheating during SCGE/Comet assays, typically performed at high current settings over 300mA; and to inhibit DNA repair enzyme activity by maintaining the slide temperature at 4°C, either during preparation and mounting or pre-incubation and electrophoresis
- **Buffer recirculation ports** - can be connected to a peristaltic pump to maintain buffer circulation, preventing ion gradient formation
- **Colour-coded handles** - corresponding to the anode and cathode - serve as a visual aid to ensure that the slides are positioned in the correct polar orientation for the assay

COMET Single Cell Gel Electrophoresis Systems

The COMET single cell gel electrophoresis systems are designed specifically for single cell gel electrophoresis (SCGE). Comet Assays are used to detect and quantify DNA damage and repair within individual cells in genetic toxicology and carcinogenesis studies.

Buffer recirculation ports - maintain buffer circulation, preventing ion gradient formation

Opaque ebony acrylic tank and lid - provide ideal protection for techniques requiring light-sensitive stains or samples

Cooling ports - can be connected to the JULABO chiller unit to maintain slide temperature before and during electrophoresis

Cooled central platform - provides a convenient surface for slide preparation in addition to maintaining slide temperature, through a labyrinthine cooling base, during pre-incubation and electrophoresis

Colour-coded handles - corresponding to the anode and cathode - serve as a visual aid to ensure that the slides are positioned in the correct polar orientation for the assay

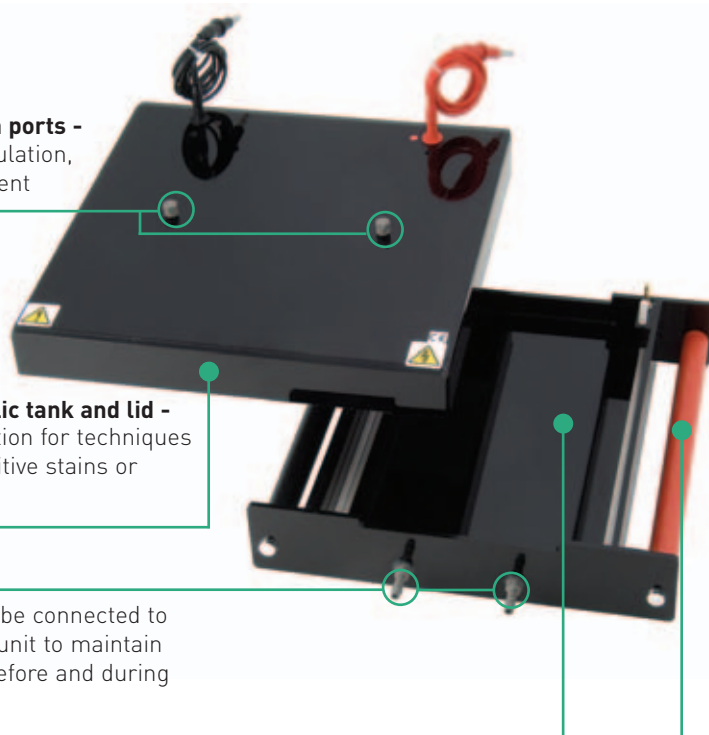

TECHNICAL SPECIFICATION

	COMET-20	COMET-40
Unit Dimensions (W x L x H)	31 x 32 x 6.5cm	31 x 47.5 x 6.5cm
Active Tank Dimensions (W x L x H)	27.5 x 21.5 x 3.5cm	27.5 x 37 x 3.5cm
Recommended Buffer Volume (ml)	600ml	800ml
Buffer Recirculation Ports	2	2
Slide Capacity (25 x 75mm; W x L)	20	40
Recommended Running Conditions	5V/cm (300mA)	5V/cm (300mA)
Power Output Connectors (diameter)	Shrouded, 4mm	Shrouded, 4mm
Recommended Power Supply	Consort EV261	Consort EV261

THE COMET ASSAY

Background - The Comet Assay/SCGE was pioneered by Östling and Johansson (1) in 1984 as a neutral pH assay to quantify double-stranded DNA breakages (DSBs) in single cells exposed to γ irradiation. Singh et al. (2) then modified the assay in 1988 to a more versatile and sensitive alkaline method to measure both single- (SSBs) and double-stranded DNA breakages. Now, by introducing subtle changes to the assay conditions (pH/temperature), the Comet Assay can be tailored to analyse specific DNA lesions and repair processes.

Overview - The Comet Assay is based on the principle that strand breakage of supercoiled duplex DNA reduces the size of the large genomic DNA molecule from which these strands are separated or stretched out by electrophoresis. The high pH of the alkaline lysis step causes denaturation, unwinding of the duplex DNA and the release of alkali labile sites as SSBs. These then become "comets" as the broken ends of the negatively charged DNA molecule migrate towards the anode during electrophoresis.

Method - Cells, previously exposed to a genotoxic insult, are suspended in low melting point agarose (LMP) and embedded in a thin agarose gel on a microscope

slide. All cellular proteins are then removed by lysis in detergent solution, when the DNA is allowed to unwind in the neutral/alkaline pH conditions of the detergent. The DNA is electrophoresed and then stained with a DNA-specific fluorescent dye such as acridine orange, ethidium bromide, propidium iodide or 4',6'-diamidino-2-phenylindole (DAPI).

Result - Upon staining cellular DNA is measured for fluorescence, usually with a microscopy imaging system. The resulting image resembles a "comet", with the cellular DNA segregating into a "head" and "tail". The head is composed of largely intact genomic DNA, while the tail comprises damaged (SSBs, DSBs) or fragmented DNA, with the fluorescence intensity and length of the tail being directly proportional to the extent of the DNA damage.

References - 1. Östling, O., and Johanson, K.J., Microelectrophoretic study of radiation-induced DNA damages in individual mammalian cells. *Biochem. Biophys. Res. Commun.*, 123, 291-8 (1984).

2. Singh, N.P, et al., A simple technique for quantitation of low levels of DNA damage in individual cells. *Exp. Cell Res.*, 175, 184-91 (1988).

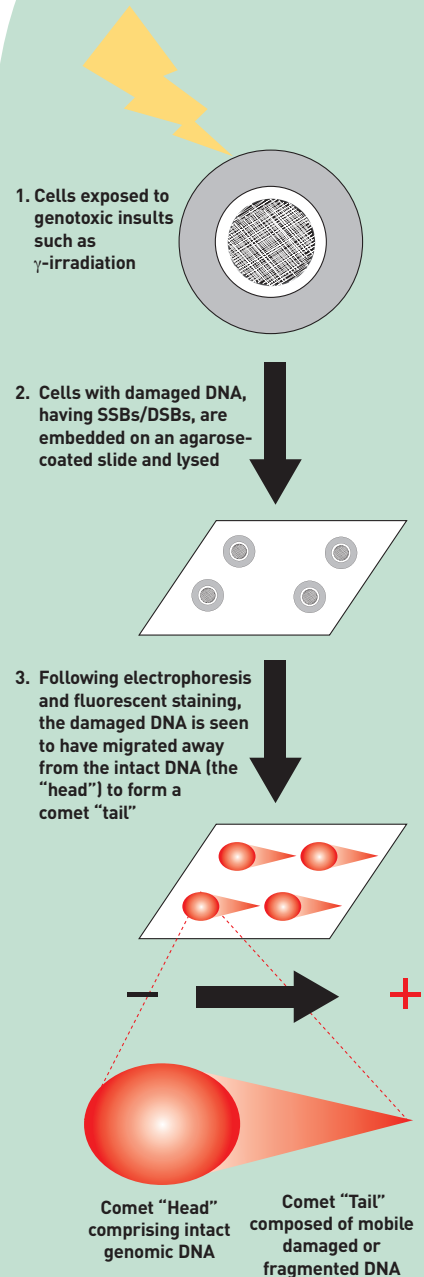

ORDERING INFORMATION

Comet Single Cell Gel Electrophoresis Systems Complete System

	Part No.
Comet assay system for twenty 75 x 25mm slides, including 27.5 x 21.5cm tank and lid made in ebony acrylic	COMET-20
Comet assay system for forty 75 x 25mm slides, including 27.5 x 37cm tank and lid made in ebony acrylic	COMET-40

Replacement Parts & Accessories

2 x 1 metre power leads with shrouded 4mm power output connectors	CABLE-4
Platinum Wire - 2 x 0.2mm thick platinum electrode wire	PT-0.2

Chemicals & Reagents

1 x 100g Agarose low melting research grade	11408.03
1 x 100g Ethylenediamine tetraacetic acid.Na ₂ -salt	11280.01
1 x 1kg Boric acid analytical grade	15165.01
1 x 1kg Tris(hydroxymethyl)aminomethane	37190.02
1 x 250ml Triton® X-100 molecular biology grade	39795.02
1 x 1kg Sodium dodecyl sulphate pellets	20765.03
1 x 50g Acridine orange research grade	10665.02
1 x 5g Ethidium bromide research grade	21238.02
1 x 25mg Propidium iodide research grade	33671.01
1 x 10mg 4',6'-diamidino-2-phenylindole.2HCL.H ₂ O (DAPI) analytical grade	18860.01



Horizontal Gel Units

BENEFITS INCLUDE

- **Ceramic cooling plate -**
27 x 27cm (W x L) - can support either...
 - One 245 x 125mm or two 125 x 125mm SERVALYT™ PRECOTES™ IEF gels (see page 121);
 - Or up to a maximum of 30 IPG BlueStrips, each 3mm wide and up to 24cm in length (see page 122)
- Ceramic cooling plate can also be connected to an external chiller to maintain IEF at...
 - 4°C for SERVALYT™ PRECOTES™ and PreNet™ IEF gels
 - 20°C for IPG BlueStrips
- **Acrylic electrode frame -** sits directly on the ceramic cooling plate for IEF with SERVALYT™ PRECOTES™ and PreNet™ IEF gels
- **Glass electrode frame -** sits flush with the ceramic cooling plate for optimal cooling efficiency and minimises mess caused by oil application during IEF with IPG strips
- **Positive and negative electrodes -** made from clear acrylic clip neatly within the acrylic or glass electrode frame, allowing the voltage gradient to be fine-tuned along the entire length of each IPG strip
- **Glass electrode weight -** ensures that the electrodes remain in complete contact with the positive and negative ends of each IPG strip or IEF gel during IEF
- **2mm shrouded power output connectors -** compatible with high voltage power supplies
- **IEF tank or cooling plate -** can also be used for wick-based horizontal gel electrophoresis

The IEF-SYS Dedicated Isoelectric Focusing Unit

The recently redesigned Scie-Plas IEF-SYS unit has been optimised for isoelectric focusing applications using IPG BlueStrips and SERVALYT™ PRECOTES™ and PreNet™ IEF gels, also available through Scie-Plas.

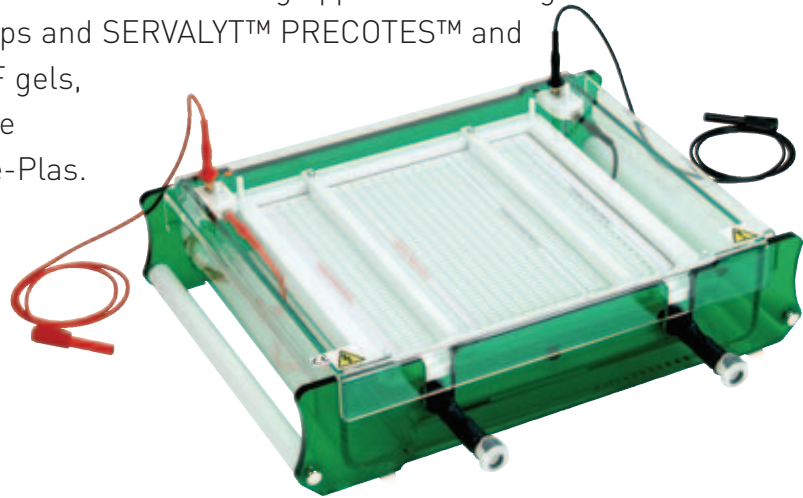

TECHNICAL SPECIFICATION

IEF-SYS Unit							
Maximum Sample Capacity	30 x IPG strips (dimensions ranging from 70 x 3 x 1mm to 240 x 3 x 1mm [L x W x T]) 1 x 245 x 125mm or 2 x 125 x 125mm (W x L) SERVALYT™ PRECOTES™ IEF gels						
Unit dimensions (W x D x H) inc. cooling coil	46 x 41 x 11.5cm						
Inner Tank Dimensions (W x D x H)	37 x 31 x 8.5cm						
Glass plate active dimensions (W x L x D)	27 x 27 x 0.5cm						
Electrode frame active dimensions (W x L x H)	27 x 27 x 1cm						
Cooling plate dimensions (W x L x D)	27 x 27 x 3cm						
Glass electrode weight active dimensions (W x L x H)	20 x 26.5 x 1cm						
Adjustable electrodes active dimensions (W x L x H)	10 x 265 x 13mm						
Recommended temperature for cooling plate during IEF with IPG strips	20°C						
Recommended temperature for cooling plate during IEF with IEF gels	4°C						
Power Output Connectors (diameter)	Shrouded, 2mm						
Recommended Running Conditions for IEF with 125mm long SERVALYT™ PRECOTES™ IEF gels	Voltage Step	1	2	3	4	5	6 end of run
	Voltage (V)	300	600	1000	1200	1500	2000
	Time (min)	20	20	30	30	30	60
Recommended Running Conditions for IEF of 7cm IPG strips	Voltage Step	1	2	3	4	5	6 end of run
	Voltage (V)	150	300	600	1500	3000	330
	Time (h)	0.5	0.5	0.5	0.5	2.5	<20
Recommended Running Conditions for IEF of 18cm IPG strips	Voltage Step	1	2	3	4	5 end of run	
	Voltage (V)	300	600	1500	3000	330	
	Time (h)	1	1	1	12.5	<20	
Snap-lock Connectors for Cooling Coil	Inner Diameter	10mm	Outer Diameter	12mm			
	Quick-fit Tubing	Inner Diameter	10mm	Outer Diameter	12mm		

Shrouded 2mm power output connectors compatible with all modern commercially available high voltage power supplies

Ceramic cooling plate is connected to the external chiller to maintain IEF at 4 or 20°C for IEF gels or IPG strips

Adjustable electrodes - clip into slots within the acrylic or glass electrode frames, while the glass electrode support slab maintains uniform contact between the electrode and paper wicks for the IEF gel or IPG strip

Acrylic or glass electrode frame can be adapted for IEF with IEF gels and IPG strips respectively

SERVALYT™ PRECOTES™: OUTLINE PROTOCOL

1. Set the cooling temperature of the external chiller, connected to the cooling plate by quick-fit tubing, to 4°C at least 10 minutes before using the unit.
2. Place the gel directly on top of the area covered by Bayol F or kerosene and, by using a pipette or electrophoresis roller (42991.01), gently disperse any bubbles underneath the gel.
3. Immerse each electrode wick (42988.01) in its respective electrode solution (Scie-Plas recommends 100µl of electrode solution per cm of wick), depending on whether it is the anode (42984.03) or the cathode (42986.03). The length of the electrode wicks should correspond to the width of the precast gel.
4. Position the electrode wicks at either end of the IEF gel, at least 5mm inside each edge, so that they are aligned parallel with the red and black strips at either end of the gel. The distance between each electrode should be 10cm for SERVALYT™ PRECOTES™ IEF gels.
5. Place a clean, washed applicator strip (42915.01) in the middle of the gel.
6. Load 10µl of protein sample into each well with a pipette, reserving at least one well for a 10µl-aliquot of SERVA Liquid Mix IEF Markers 3-10 (39212.01).
7. After loading the gel, carefully lower the glass electrode weight over the anode and cathode electrodes, so that they remain in contact with the electrode wicks and gel during the application.
8. Perform IEF according to the recommended running conditions in Technical Specification. Once IEF is complete, the SERVALYT™ PRECOTES™ IEF gel is ready for staining.

ORDERING INFORMATION

Complete System

Part No.

Flat-bed isoelectric focusing unit includes running tank, lid,
1 x ceramic cooling plate, 1 x glass electrode frame, 1 x electrode frame,
1 x anode electrode, 1 x cathode electrode,
1 x glass electrode weight,
2 x quick-fit tubes and 2 x 2mm power cables

IEF-SYS

Replacement Parts & Accessories

1 x ceramic cooling plate for IEF-SYS	IEF-CP
1 x glass electrode frame for IEF-SYS	IEF-GF
1 x electrode frame for IEF-SYS	IEF-EF
1 x cathode electrode for IEF-SYS	IEF-CE
1 x anode electrode for IEF-SYS	IEF-AE
1 x glass electrode weight for IEF-SYS	IEF-GS
2 x quick-fit tubes for cooling plate for IEF-SYS	TCS-CC
2 x 1 metre power leads with shrouded 2mm power output connectors	CABLE-2
Platinum Wire	PT-0.2100CM

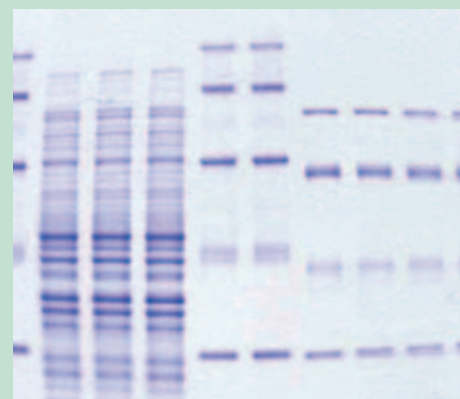

Protein samples in a SERVALYT™ PRECOTES™ Wide Range pH 3-10 IEF gel following IEF with the IEF-SYS unit and fixation and staining with SERVA Violet 17.

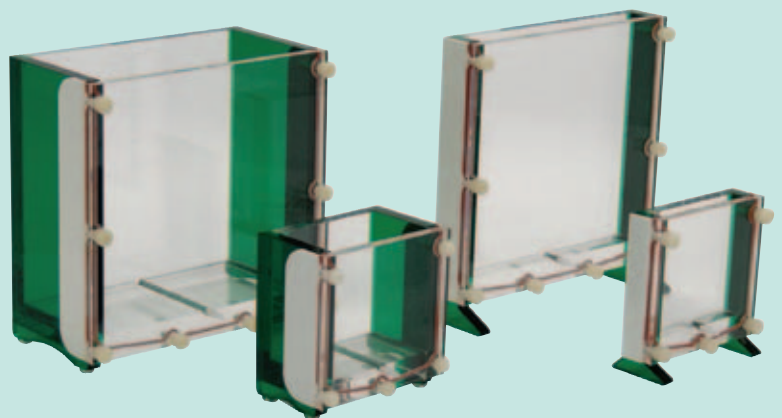



Vertical Gel Units

The TV Range

The Scie-Plas 'TV Range' vertical gel electrophoresis units offer the ultimate standards in innovative design and manufacture acquired during our 20+ year existence.

The 'TV Range' vertical gel electrophoresis units are available in a range of different sizes for applications ranging from routine SDS-PAGE mini-gels to large format nucleic acid sequencing and single-strand conformational polymorphism studies (SSCP). As with our 'Green Range' horizontal gel units, each 'TV Range' vertical gel electrophoresis unit

incorporates the many design and safety features recommended to us over the years by scientists, either from within our in-house product development team or laboratories worldwide. Accordingly, each unit is manufactured and finished to the highest specification, versatile, easy to use and fully compliant with European safety regulations.

Vertical Gel Units

FEATURES

1. Tank and Lid
2. Power Output Connectors
3. Cooling Coil
4. New-Style Gel-Running Module
5. Dummy Plate
6. Cam-Pin Casting Base
7. Silicone Seals
8. Colour-Coded Spacers
9. Colour-Coded Combs
10. Plain Glass Plates - also available with bonded spacers
11. Notched Glass Plates
12. Spacer Aligners
13. Quick-Fit Tubing With Snap-Lock Connectors
14. Electroblotting Cassette
15. Fibre Pads
16. Glass Capillary Tubes
17. Gel Extraction Platform
18. Blanking Ports
19. Capillary Gel-Running Module (CAPGRM)
20. Electroblotting Gel-Running Module (EBGRM)

BENEFITS INCLUDE

- Robust acrylic tank construction
- Safety lid with integral power leads
- Shrouded 4 and 2mm power output connectors universally compatible with modern-day low, medium and high voltage power supplies
- Long-life, 99.99% pure platinum electrodes
- Gold-plated terminals with corrosion-free stainless steel washers
- Offset asymmetric electrodes
- A versatile, time-saving gel-running module (GRM) which supports both gel-casting and electrophoresis
- Durable high-impact polystyrene (HIPS) and melinex combs which are colour-coded, corresponding to 0.25, 0.35, 0.75, 1, 1.5 and 2mm thicknesses
- Electroblotting and 2-D capillary gel modules available for use within the same tank either as part of a fully integrated system or as a stand-alone unit (TV100 & 400 units only)

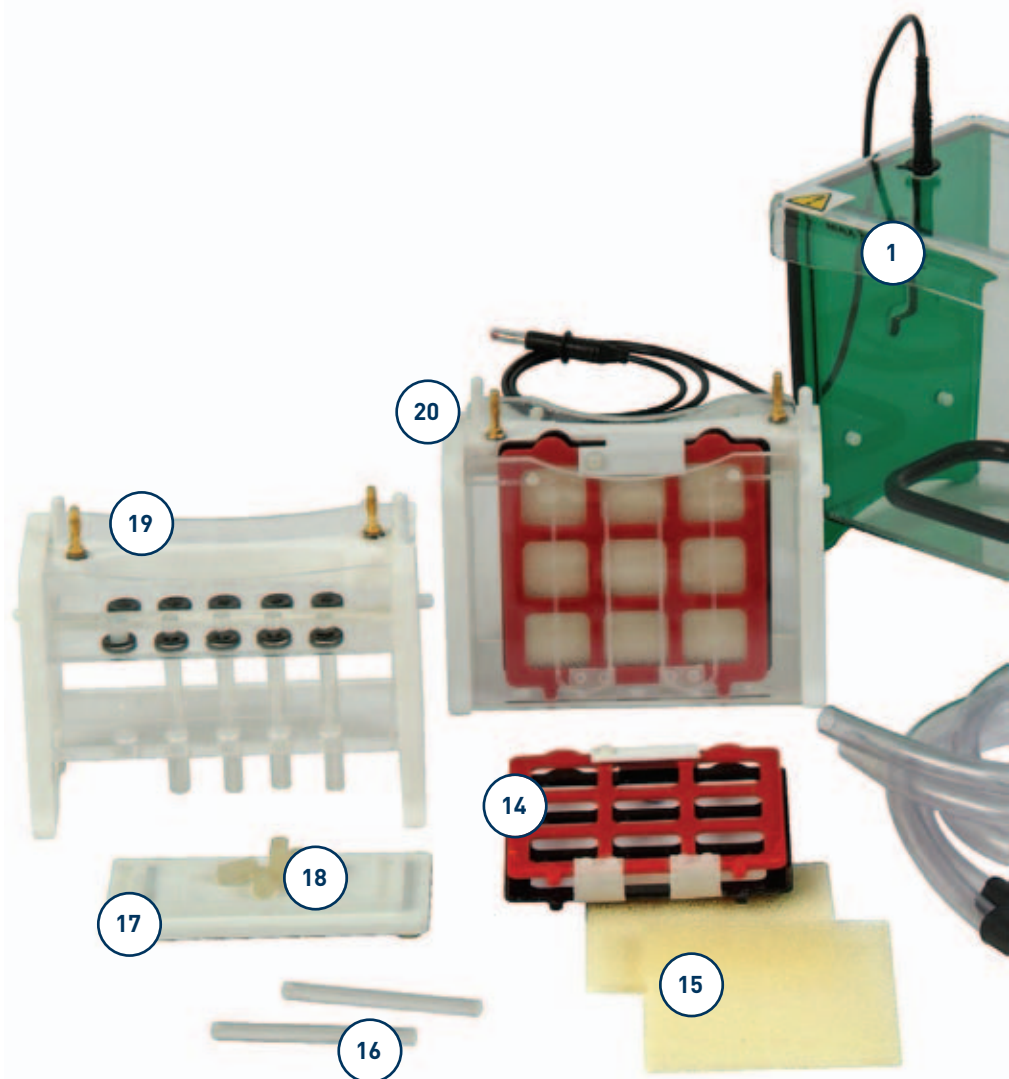

The 'TV Range' vertical gel electrophoresis units are available in a range of different formats: -

The **TV50** single-plate 10 x 10cm (W x H) mini-gel unit is a good, cost-effective option for routine, low throughput separation of proteins and nucleic acids in self-cast or commercially available precast gels.

The **TV100** twin-plate 10 x 10cm (W x H) mini-gel unit is, historically, our best selling vertical gel electrophoresis unit which is designed for all standard polyacrylamide gel electrophoresis (PAGE) applications. This unit is ideal for use with commercially available precast gels or gels cast using our new-style GRM and cam-pin casting base. Here, gel cassettes are placed within the GRM and then pulled tightly onto silicone seals by cam pins located in the casting base. Glass plate stops situated within the GRM immediately above the glass plates serve as an

immovable barrier, locking the plates firmly into position on the casting base as the cam pins are turned clockwise through 120°. The gel can then be poured in total confidence that it will be leak-free. Each TV100 unit is also available as a cooled tank option, and can be adapted, either as a stand-alone unit or as part of a fully integrated system, with specific modules for electroblotting and 2-D electrophoresis.

The **TV200** twin-plate 20.5 x 10cm (W x H) wide format mini-gel electrophoresis unit allows more samples to be run within the same gel, eliminating the problems that can be associated with comparing samples from 2 separate mini-gels. The TV200 offers the same benefits as the TV100, including a GRM with glass plate stops and cam-pin casting system, in addition to a cooled-tank and modular electroblotting and capillary gel 2-D electrophoresis options.

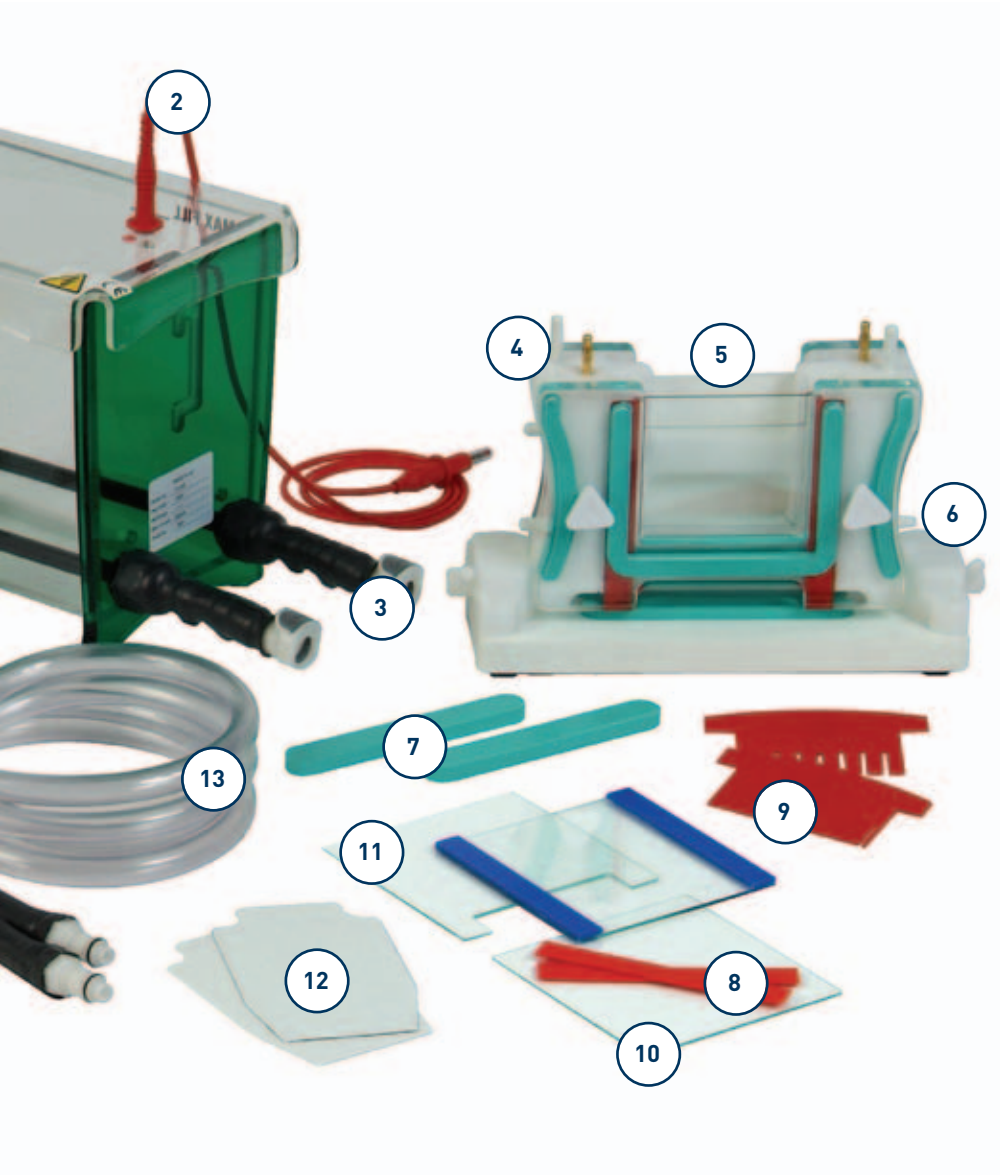

The **TV400** twin-plate 20.5 x 20cm (W x H) maxi-gel unit offers all the benefits of the TV100 and 200 units, but in a much larger gel size and with greater sample throughput. The TV400-GRM also includes glass plate stops which act in tandem with the cam-pin casting base to provide leak-proof casting, whereas an optional cooled tank format can be connected either to the laboratory water supply or external chiller to maintain the cooling necessary for high quality resolution. Specific modules again allow the TV400 to be adapted either as stand-alone electroblotting and 2-D electrophoresis units or as a fully integrated system.

The **TVS1400** single-plate 33 x 41cm (W x H) large format vertical gel unit allows more samples to be processed during each electrophoretic separation.

Format	Options Available				Recommended Applications*				
	Standard (i.e. no casting or cooling)	Casting only	Cooling only	Cooling & casting	PAGE	Electroblotting	2-D Capillary	DNA Sequencing	SSCP heteroduplex & oligonucleotide analysis
TV50 single-plate 10 x 10cm (W x H) mini-gel	✓ See TV50				✓				
TV100 twin-plate 10 x 10cm (W x H) mini-gel	✓ See TV100	✓ TV100Y	✓ TV100K	✓ TV100YK	✓ TV100, TV100Y, TV100K, TV100YK	✓ TV100YK-EBSYS, TV100YK-MODSYS	✓ TV100YK-2DSYS, TV100YK-MODSYS		
TV200 twin-plate 20.5 x 10cm (W x H) wide format mini-gel	✓ See TV200	✓ TV200Y	✓ TV200K	✓ TV200YK	✓ TV200, TV200Y,				
TV400 twin-plate 20.5 x 20cm (W x H) maxi-gel	✓ See TV400	✓ TV400Y	✓ TV400K	✓ TV400YK	✓ TV400, TV400Y, TV400K, TV400YK	✓ TV400YK-EBSYS, TV400YK-MODSYS	✓ TV400YK-2DSYS, TV400YK-MODSYS		SEE TV400-DGGE
TVS1400 single-plate 33 x 41cm (W x H) large format vertical gel	✓ See TVS1400							✓ TVS1400	✓ TVS1400

*Where the TV100YK-EBSYS & TV400YK-EBSYS units include PAGE (GRM) and electroblotting (EBGRM) gel-running modules plus casting and cooling

The TV100YK-2DSYS & TV400YK-2DSYS units include PAGE and 2-D capillary gel-running modules (CAPGRM) plus casting and cooling

The TV100YK-MODSYS & TV400YK-MODSYS units include PAGE, electroblotting and 2-D capillary gel-running modules plus casting and cooling

Vertical Gel Units

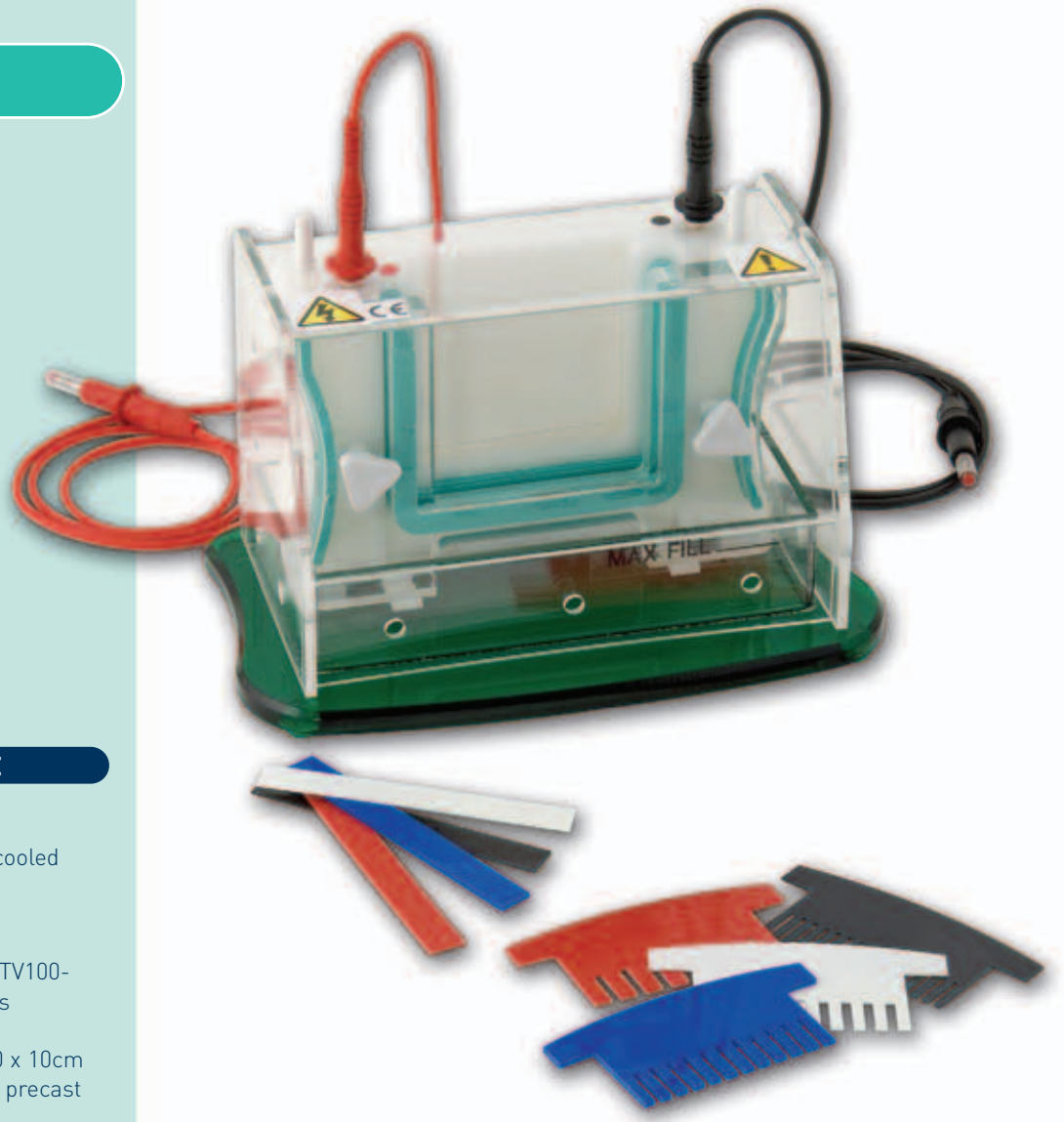

BENEFITS INCLUDE

- **Single-plate 10 x 10cm mini-gel unit** - a simple, non-cooled cost-effective solution for low throughput PAGE
- **Gel casting** - TV100-MC2 and TV100-MC10 2 and 10 gel multicasters
- **Compatible** - with standard, 10 x 10cm (W x H) commercially available precast gels
- **Optional TV100-SGB silicone gasket** - allows the GRM to be adapted for the 'non-eared' or short glass plates of major competitor brands
- **Float glass plates** - 2mm thick - guarantee uniform gel thickness and even sample migration, and with ground edges to inhibit sample leakage during casting
- **Single screws** - for fast electrophoresis set-up
- **Low buffer volumes** - within the inner chamber of the GRM and bottom reservoir economises buffer consumption
- **Ventilation holes** - prevent the build-up of condensation during electrophoresis
- **Colour-coded combs and spacers** - available in 0.75, 1, 1.5 and 2mm thicknesses
- **Small footprint area** - occupies minimal bench space

The TV50 Single-Plate Mini-Gel Electrophoresis Unit

The TV50 single-plate 10 x 10cm (W x H) mini-gel unit is the ideal cost-effective option for routine, low throughput separation of proteins and nucleic acids in self-cast or commercially available precast gels.

ORDERING INFORMATION

Complete System

Single-plate mini-gel unit with GRM and integral lower buffer chamber, lid, 2 x (10 x 10cm; W x H) plain glass plates	
2 x 1mm spacers, 2 x spacer aligners,	
2 x (10 x 10cm) notched glass plates and 1 x 1mm thick 12-sample comb	TV50

Replacement Parts & Accessories

2 x (10 x 10cm) plain glass plates with 0.75mm bonded spacers for TV50	TV100-PGS0.75
2 x (10 x 10cm) plain glass plates with 1mm bonded spacers for TV50	TV100-PGS1
2 x (10 x 10cm) plain glass plates with 1.5mm bonded spacers for TV50	TV100-PGS1.5
2 x (10 x 10cm) plain glass plates with 2mm bonded spacers for TV50	TV100-PGS2
2 x (10 x 10cm) plain glass plates for TV50	TV100-PG
2 x (10 x 10cm) notched glass plates for TV50	TV100-NG
2 x 0.75mm thick spacers for TV50	TV100-S0.75
2 x 1mm thick spacers for TV50	TV100-S1
2 x 1.5mm thick spacers for TV50	TV100-S1.5
2 x 2mm thick spacers for TV50	TV100-S2
2 x spacer aligners for TV50	TV100-SA
1 x caster system for 2 x (10 x 10cm) gradient mini-gels	TV100-MC2
1 x caster system for 10 x (10 x 10cm) gradient mini-gels	TV100-MC10
2 x 0.2mm thick, platinum electrode wire	PT-0.2
2 x 1 metre power leads with shrouded 4mm power output connectors	CABLE-4

TV50 Combs

Part No.	Thickness (mm)	Sample Throughput	Tooth Width (mm)	Tooth Height (mm)	Max. Spacing (mm)	Sample Volume / Well (µl)
*TV100-C0.75-8MC	0.75	8	6	15	3	67
TV100-C0.75-10	0.75	10	4	15	3	45
TV100-C0.75-12	0.75	12	3.75	15	2.25	42
*TV100-C0.75-16MC	0.75	16	2.5	15	2	28
TV100-C0.75-20	0.75	20	2	15	1.5	22
*TV100-C1-8MC	1	8	6	15	3	90
TV100-C1-10	1	10	4	15	3	60
TV100-C1-12	1	12	3.75	15	2.25	56
*TV100-C1-16MC	1	16	2.5	15	2	37
TV100-C1-20	1	20	2	15	1.5	30
*TV100-C1.5-8MC	1.5	8	6	15	3	120
TV100-C1.5-10	1.5	10	4	15	3	90
TV100-C1.5-12	1.5	12	3.75	15	2.25	84
*TV100-C1.5-16MC	1.5	16	2.5	15	2	55
TV100-C1.5-20	1.5	20	2	15	1.5	45
*TV100-C2-8MC	2	8	6	15	3	180
TV100-C2-10	2	10	4	15	3	120
TV100-C2-12	2	12	3.75	15	2.25	112
*TV100-C2-16MC	2	16	2.5	15	2	75

*Multi-channel compatible

TECHNICAL SPECIFICATION

Unit Dimensions (W x D x H)	21.5 x 12.5 x 13.5cm
Bottom Reservoir Dimensions (W x D x H)	16.5 x 6 x 3.5cm
Plate Dimensions (W x H x T)	10 x 10 x 0.2cm
Standard Spacer Dimensions (W x H x T)	1 x 10 x 0.1cm
Active Gel Dimensions (W x H)	8 x 8.5cm
Maximum Sample Capacity	1 x 20
Recommended Buffer Volume	
Inner Buffer Chamber	50ml
Lower Buffer Chamber	250ml
Recommended Running Conditions for Denaturing/Native PAGE Gel	
Voltage	50 - 100V (5 - 10V/cm)
Current	5 - 10mA
Time	1.5 - 2.5h
Power Output Connectors (diameter)	Shrouded, 4mm
Recommended Power Supply	Consort EV243

Exploded View of a Scie-plas Gel Cassette

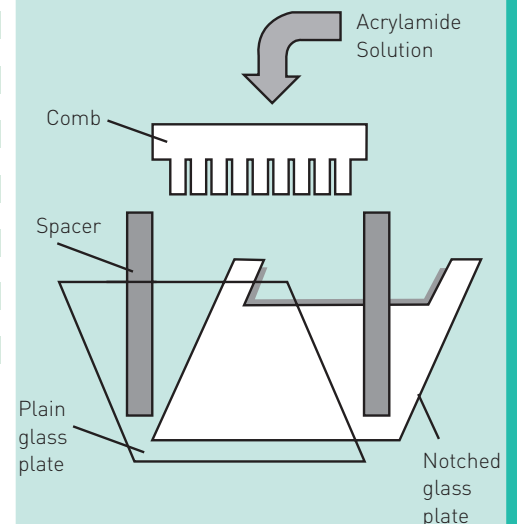

Vertical Gel Units

BENEFITS INCLUDE

- **Twin-plate 10 x 10cm mini-gel unit** - a simple cost-effective solution for PAGE techniques using either self-cast or precast gels

- **Two versions available:** -

Standard TV100 - non-cooled

Cooled TV100K - a cooling coil in the bottom of the gel tank for faster higher voltage electrophoretic separations

- **Enhanced cooling** - in the TV100K - snap-lock connectors allow the TV100K to be connected to the external chiller unit

- **Compatible** - with commercially available 10 x 10cm precast gels



- **Precast gels** - (see page 123)

- **Optional TV100-SGB silicone gasket** - allows the GRM to be adapted for the 'non-eared' or short glass plates of major alternative brands

- **Gel casting** - either with tape or the optional TV100-CB casting base or TV100-MC2 and TV100-MC10 2 and 10 gel multicasters

- **Float glass plates - 2mm thick** - guarantee uniform gel thickness and even sample migration, and with ground edges to inhibit sample leakage during casting

- **Single screws** - at either side each gel-clamping plate - act in conjunction with a counterbalanced, dovetailed silicone gasket to disperse pressure evenly along the height and breadth of the gel as the screws are tightened

- **Low buffer volumes** - within the inner chamber of the GRM and gel tank economises buffer consumption

- **Colour-coded combs and spacers** - available in 0.75, 1, 1.5 and 2mm thicknesses

- **Smaller footprint area** - occupies minimal bench space

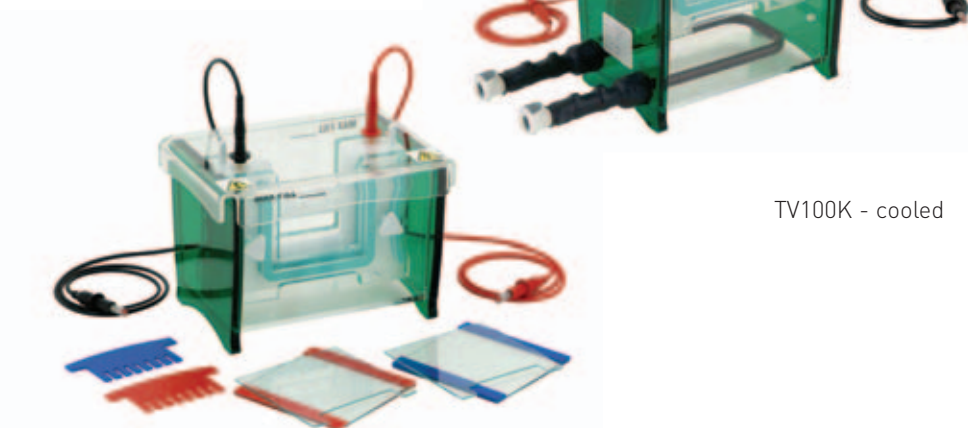

TV100 - non-cooled

TV100K - cooled

TV100 Standard & TV100K Cooled Twin-Plate Mini-Gel Electrophoresis Units

The TV100 and TV100K twin-plate 10 x 10cm (W x H) mini-gel units are ideal cost-effective solutions for standard PAGE applications, using self-cast or commercially available precast gels.

TECHNICAL SPECIFICATION

	TV100		TV100K	
Unit Dimensions (W x D x H)	20 x 15 x 14cm		28 x 15 x 18cm	
Inner Tank Dimensions (W x D x H)	16.5 x 11 x 11.5cm		16.5 x 11 x 15cm	
Plate Dimensions (W x H x T)	10 x 10 x 0.2cm		10 x 10 x 0.2cm	
Standard Spacer Dimensions (W x H x T)	1 x 10 x 0.1cm		1 x 10 x 0.1cm	
Active Gel Dimensions (W x H)	8 x 8.5cm		8 x 8.5cm	
Maximum Sample Capacity	2 x 16		2 x 16	
Recommended Buffer Volume	Inner Buffer Chamber	90ml	Inner Buffer Chamber	90ml
	Gel Tank	1200ml	Gel Tank	1600ml
Recommended Running Conditions for Denaturing/Native PAGE Gel	Voltage	50 - 100V (5 - 10V/cm)	Voltage	100 - 150V (10 - 15V/cm)
	Current	5 - 10mA	Current	10 - 15mA
	Time	1.5 - 2.5h	Time	1 - 1.75h
Snap-lock Connectors for Cooling Coil	Inner Diameter	n/a	Inner Diameter	10mm
	Outer Diameter	n/a	Outer Diameter	12mm
Quick-fit Tubing	Inner Diameter	n/a	Inner Diameter	10mm
	Outer Diameter	n/a	Outer Diameter	12mm
Power Output Connectors (diameter)	Shrouded, 4mm		Shrouded, 4mm	
Recommended Power Supply	Consort EV243		Consort EV243	

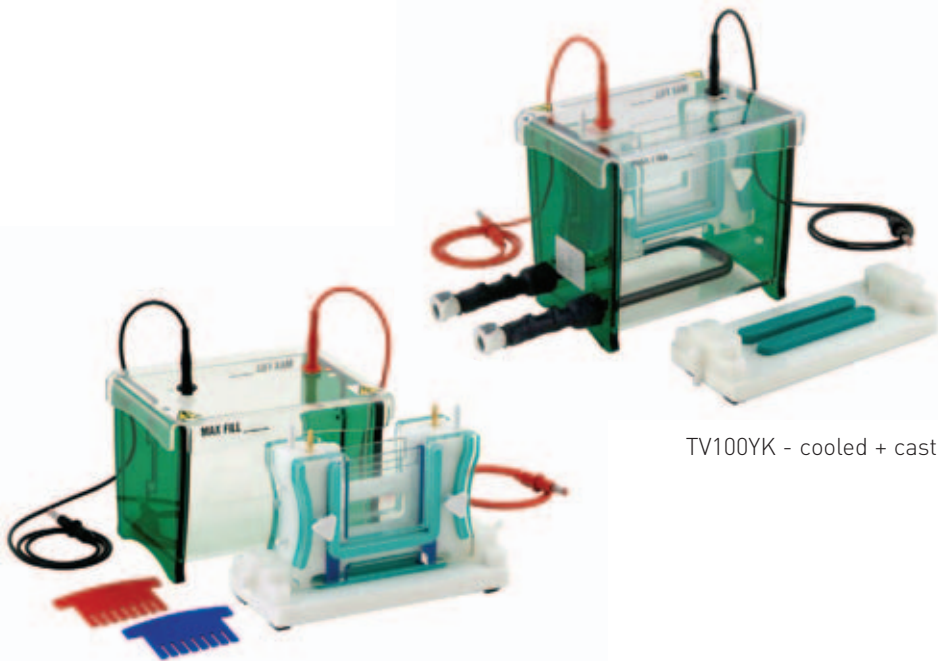

TV100Y - non-cooled + casting

TV100YK - cooled + casting

TV100Y Standard & TV100YK Cooled Twin-Plate Mini-Gel Electrophoresis Units

The TV100Y and TV100YK twin-plate 10 x 10cm (W x H) mini-gel units are ideal for standard PAGE applications requiring self-cast gels. Soft silicone gaskets in a precision engineered casting base, included as standard with each unit, act in tandem with our newly modified GRM to provide simple, leak-free gel casting and assembly.

TECHNICAL SPECIFICATION

	TV100Y	TV100YK
Unit Dimensions (W x D x H)	20 x 15 x 14cm	28 x 15 x 18cm
Inner Tank Dimensions (W x D x H)	16.5 x 11 x 11.5cm	16.5 x 11 x 15cm
Plate Dimensions (W x H x T)	10 x 10 x 0.2cm	10 x 10 x 0.2cm
Standard Spacer Dimensions (W x H x T)	1 x 10 x 0.1cm	1 x 10 x 0.1cm
Active Gel Dimensions (W x H)	8 x 8.5cm	8 x 8.5cm
Maximum Sample Capacity	2 x 16	2 x 16
Recommended Buffer Volume	Inner Buffer Chamber 90ml Gel Tank 1200ml	Inner Buffer Chamber 90ml Gel Tank 1600ml
Recommended Running Conditions for Denaturing/Native PAGE Gel	Voltage	50 - 100V (5 - 10V/cm)
	Current	5 - 10mA
	Time	1.5 - 2.5h
Snap-lock Connectors for Cooling Coil	Inner Diameter	n/a
	Outer Diameter	n/a
Quick-fit Tubing	Inner Diameter	n/a
	Outer Diameter	n/a
Casting Base Silicone Seal Dimensions (W x L x H)	1.5 x 11 x 0.8cm	1.5 x 11 x 0.8cm
Power Output Connectors (diameter)	Shrouded, 4mm	Shrouded, 4mm
Recommended Power Supply	Consort EV243	Consort EV243

BENEFITS INCLUDE

- **Twin-plate 10 x 10cm mini-gel unit** - designed specifically for PAGE techniques requiring self-cast gels, although precast gels may also be used
- **Casting base** - included as standard with both units
- **Two versions available:** -
Standard TV100Y - non-cooled + casting
Cooled TV100YK - cooled + casting
- **Glass plate stops** - within the newly modified GRM - lock the glass plates firmly into position onto soft silicone gaskets in the casting base to ensure leak-free gel-casting
- **Enhanced cooling** - in the TV100YK - snap-lock connectors allow the cooling coil to be connected to an external chiller unit for faster, higher voltage separations
- **Compatible** - with commercially available 10 x 10cm precast gels, with precast gels available through Scie-Plas for the TV100-GRM (see page 123)
- **Additional gel casting** - with the optional TV100-MC2 and TV100-MC10 2 and 2 gel multicaster
- **Float glass plates** - 2mm thick - guarantee uniform gel thickness and even sample migration, and with ground edges to inhibit sample leakage during casting
- **Single screws** - at either side each gel-clamping plate - act in conjunction with a counterbalanced, dovetailed silicone gasket to disperse pressure evenly along the height and breadth of the gel as the screws are tightened
- **Low buffer volumes** - within the inner chamber of the GRM and gel tank economises buffer consumption
- **Colour-coded combs and spacers** - available in 0.75, 1, 1.5 and 2mm thicknesses
- **Smaller footprint area** - occupies minimal bench space

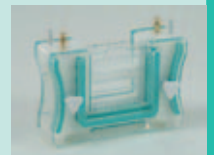

CASTING WITH NEW-STYLE GRM

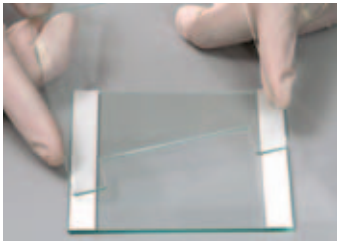

1. Place each plain glass plate on a level bench surface, followed by the spacers and then the notched glass plate

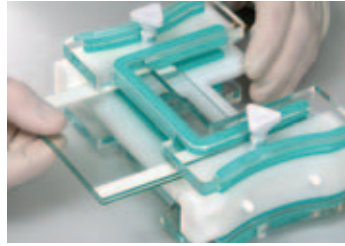

2. Insert the glass plate cassette into the gel-running module (GRM), placed on its side on the bench, and lightly tighten the screws - repeat for the other cassette by turning the GRM on its other side



3. If not using plain glass plates with bonded spacers, get a spacer aligner to align the spacers flush with the vertical edges of the plain glass plates before tightening the screws within the GRM

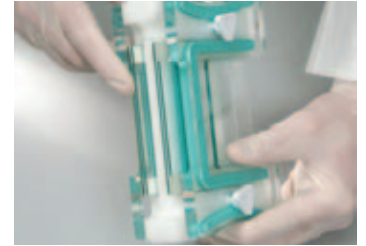

4. Run your forefinger along the bottom edge of the glass plates to ensure that they are flush with bottom edge of each spacer - if not, repeat step 3

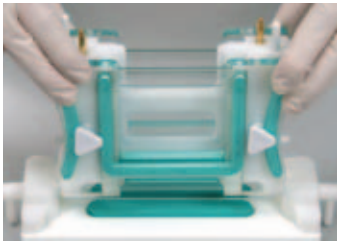

5. Lower the assembled GRM onto the casting base with the cam pins pointing downwards into the bench surface

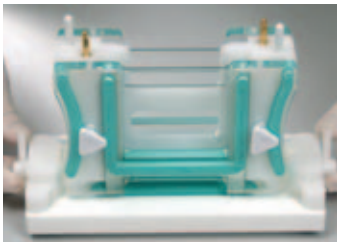

6. Turn the cam pins through 120° to secure the GRM onto the casting base - as you turn the cam pins you will experience increased resistance

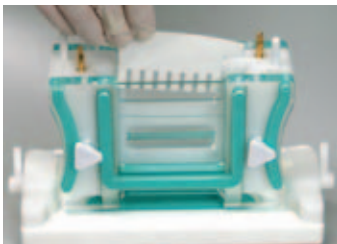

7. Carefully insert the appropriate comb allowing the gel to set for at least 30 minutes

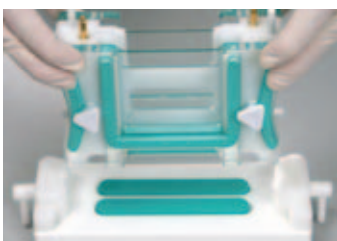

8. After carefully removing the combs, release the GRM by turning the cam pins in the opposite direction on the casting base

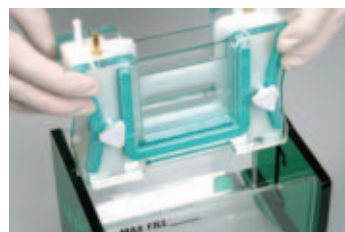

9. Place the GRM into the gel tank, ensuring that there is sufficient buffer to cover the bottom of the glass plates

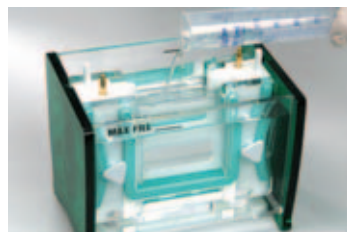

10. Fill the inner buffer chamber within the GRM so that it just covers the top of the gel - the gel is now ready to be loaded

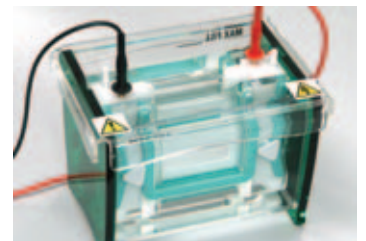

11. Replace the lid and insert the power cables into the power supply, making sure that it is first switched off - the unit is now ready for electrophoresis

Glass plate stops - serve as an immovable barrier, locking the glass plates firmly into position on the casting base

Single screws - act, as they are tightened, with a silicone dovetailed gasket to apply an even pressure across the height and breadth of the gel that prevents the inner gel chamber from leaking

Casting base - re-engineered with deeper recesses to accommodate soft silicone seals which sit flush with the bottom of each glass plate

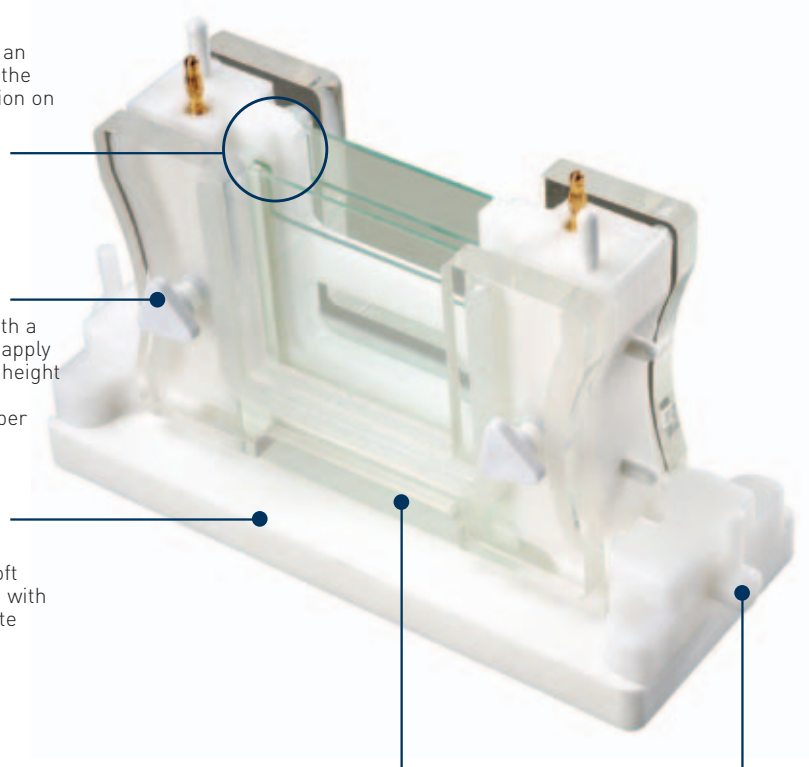

Silicone seals - form a leak-free seal as the glass plates are dragged onto the casting base

Cam pins - turned clockwise to drag the glass plates firmly onto the silicone seals within the casting base

Complete System

Twin-plate mini-gel unit with GRM and gel tank, lid,
2 x (10 x 10cm; W x H) plain glass plates, 4 x 1mm spacers,
2 x spacer aligners, 2 x (10 x 10cm) notched glass plates,
1 x dummy plate and 2 x 1mm thick 12-sample combs

Part No.



TV100

Twin-plate mini-gel unit with GRM and cooled gel tank,
with built-in cooling coil and quick-fit tubing, plus lid,
2 x (10 x 10cm; W x H) plain glass plates, 4 x 1mm spacers,
2 x spacer aligners, 2 x (10 x 10cm) notched glass plates,
1 x dummy plate and 2 x 1mm thick 12-sample combs



TV100K

Twin-plate mini-gel unit with GRM and gel tank, lid, 2 x (10 x 10cm;
W x H) plain glass plates, 4 x 1mm spacers, 2 x spacer aligners,
2 x (10 x 10cm) notched glass plates, 1 x dummy plate
and 2 x 1mm thick 12-sample combs
plus casting base and 2 x silicone seals



TV100Y

Twin-plate mini-gel unit with GRM and cooled gel tank,
with built-in cooling coil and quick-fit tubing, plus lid, 2 x (10 x 10cm;
W x H) plain glass plates, 4 x 1mm spacers, 2 x spacer aligners,
2 x (10 x 10cm) notched glass plates, 1 x dummy plate,
2 x 1mm thick 12-sample combs, casting base and 2 x silicone seals



TV100YK

Replacement Parts & Accessories

1 x TV100 gel-running module	TV100-GRM
2 x quick-fit tubes for cooling coil	TCS-CC
2 x (10 x 10cm) plain glass plates with 0.75mm bonded spacers for TV100	TV100-PGS0.75
2 x (10 x 10cm) plain glass plates with 1mm bonded spacers for TV100	TV100-PGS1
2 x (10 x 10cm) plain glass plates with 1.5mm bonded spacers for TV100	TV100-PGS1.5
2 x (10 x 10cm) plain glass plates with 2mm bonded spacers for TV100	TV100-PGS2
2 x (10 x 10cm) plain glass plates for TV100	TV100-PG
2 x (10 x 10cm) notched glass plates for TV100	TV100-NG
1 x (10 x 10 cm) dummy plate	TV100-DP
2 x 0.75mm thick spacers for TV100	TV100-S0.75
2 x 1mm thick spacers for TV100	TV100-S1
2 x 1.5mm thick spacers for TV100	TV100-S1.5
2 x 2mm thick spacers for TV100	TV100-S2
2 x spacer aligners for TV100	TV100-SA
1 x cam-pin casting base with 2 silicone seals	TV100-CB
2 x silicone seals for cam-pin casting base	TV100-CB-SEALS
1 x caster system for 2 x (10 x 10cm) gradient mini-gels	TV100-MC2
1 x caster system for 10 x (10 x 10cm) gradient mini-gels	TV100-MC10
2 x silicone gaskets for "non-eared" glass plates	TV100-SGB
2 x 0.2mm thick, platinum electrode wire	PT-0.2
2 x 1 metre power leads with shrouded 4mm power output connectors	CABLE-4

TV100 Combs

Part No.	Thickness (mm)	Sample Throughput	Tooth Width (mm)	Tooth Height (mm)	Max. Spacing (mm)	Sample Volume / Well (µl)
*TV100-C0.75-8MC	0.75	8	6	15	3	67
TV100-C0.75-10	0.75	10	4	15	3	45
TV100-C0.75-12	0.75	12	3.75	15	2.25	42
*TV100-C0.75-16MC	0.75	16	2.5	15	2	28
*TV100-C1-8MC	1	8	6	15	3	90
TV100-C1-10	1	10	4	15	3	60
TV100-C1-12	1	12	3.75	15	2.25	56
*TV100-C1-16MC	1	16	2.5	15	2	37
*TV100-C1.5-8MC	1.5	8	6	15	3	120
TV100-C1.5-10	1.5	10	4	15	3	90
TV100-C1.5-12	1.5	12	3.75	15	2.25	84
*TV100-C1.5-16MC	1.5	16	2.5	15	2	55
*TV100-C2-8MC	2	8	6	15	3	180
TV100-C2-10	2	10	4	15	3	120
TV100-C2-12	2	12	3.75	15	2.25	112
*TV100-C2-16MC	2	16	2.5	15	2	75

*Multi-channel compatible

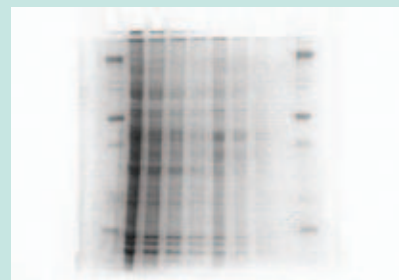

Rat supernatant proteins separated, following serial dilution, using the TV100Y mini-gel electrophoresis unit at 230V for 1 hour and 20 minutes. Proteins were resolved in a 4% polyacrylamide stacking gel and a 10% polyacrylamide resolving gel made from the following SERVA chemicals: 40% (37.5:1) acrylamide [10681.03]; 1M Tris-HCl, pH 8.5 [39794.01]; 20% (w/v) SDS solution [20767.03]; APS [13375.05]; TEMED [35925.01]; 10x Laemmli buffer [42556.01]; Tris (analytical grade) [37180.04] and Glycine (analytical grade) [23390.03]. Courtesy of The University of Coventry, UK.

DO YOU NEED...?

PRECAST SDS-PAGE GELS	SEE PAGE 123
A BLOTTING MODULE	SEE PAGE 60
ELECTROPHORESIS BUFFERS	SEE PAGE 119
RECIRCULATING CHILLER	SEE PAGE 82
COLLOIDAL COOMASSIE BLUE STAIN	SEE PAGE 119

Vertical Gel Units

BENEFITS INCLUDE

- **Twin-plate 20.5 x 10cm (W x H) wide format mini-gel unit** - designed specifically for PAGE techniques requiring self-cast gels
- **Wide format** - 20.5cm gel width effectively allows 2 mini-gels to be run within the same gel
- **Glass plate stops** - within the newly modified GRM - lock the glass plates firmly into position onto soft silicone gaskets in the casting base to ensure leak-free gel-casting
- **Additional gel casting** - with the optional TV400-CB cam-pin casting base or TV400-MC2 and 2 gel multicaster
- **Float glass plates** - 4mm thick - guarantee uniform gel thickness and even sample migration, and with ground edges to inhibit sample leakage during casting
- **Twin screws** - on each gel-clamp - act in conjunction with a counterbalanced, dovetailed silicone gasket to disperse pressure evenly along the height and breadth of the gel as the screws are tightened
- **Colour-coded combs and spacers** - available in 0.75, 1, 1.5 and 2mm thicknesses

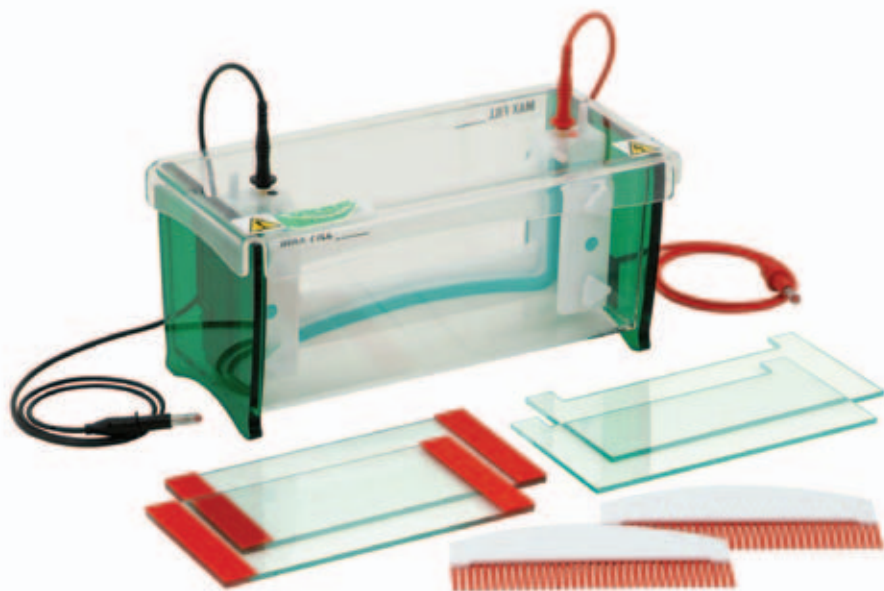

TV200

TV200 Standard Twin-Plate Wide Format Mini-Gel Electrophoresis Unit

The TV200 20.5 x 10cm (W x H) wide format mini-gel units allows more samples to be screened on the same gel, eliminating the problems associated with comparing samples from 2 separate tape-cast mini-gels.

TECHNICAL SPECIFICATION

	TV200
Unit Dimensions (W x D x H)	30 x 15 x 14cm
Inner Tank Dimensions (W x D x H)	27 x 11 x 11.5cm
Plate Dimensions (W x H x T)	20.5 x 10 x 0.4cm
Standard Spacer Dimensions (W x H x T)	2 x 20 x 0.1cm
Active Gel Dimensions (W x H)	16.5 x 8.5cm
Maximum Sample Capacity	2 x 48
Recommended Buffer Volume	Inner Buffer Chamber 300ml Gel Tank 2800ml
Recommended Running Conditions for Denaturing/Native PAGE Gel	Voltage 100 - 150V (10 - 15V/cm) Current 10 - 15mA Time 1.5 - 2h
Snap-lock Connectors for Cooling Coil	Inner Diameter n/a Outer Diameter n/a
Quick-fit Tubing	Inner Diameter n/a Outer Diameter n/a
Power Output Connectors (diameter)	Shrouded, 4mm
Recommended Power Supply	Consort EV243



TV200Y with casting

TV200Y Standard Twin-Plate Wide Format Mini-Gel Electrophoresis Unit

The TV200Y twin-plate 20.5 x 10cm (W x H) wide format mini-gel units allows more samples to be screened on the same gel, eliminating the problems associated with comparing samples from 2 separate mini-gels. This unit includes, as standard., a precision engineered casting base, which acts in conjunction with our recently modified TV200-GRM to provide simple, leak-free casting.

TECHNICAL SPECIFICATION

	TV200Y	
Unit Dimensions (W x D x H)	30 x 15 x 14cm	
Inner Tank Dimensions (W x D x H)	27 x 11 x 11.5cm	
Plate Dimensions (W x H x T)	20.5 x 10 x 0.4cm	
Standard Spacer Dimensions (W x H x T)	2 x 20 x 0.1cm	
Active Gel Dimensions (W x H)	16.5 x 8.5cm	
Maximum Sample Capacity	2 x 48	
Recommended Buffer Volume	Inner Buffer Chamber	300ml
	Gel Tank	2800ml
Recommended Running Conditions for Denaturing/Native PAGE Gel	Voltage	100 - 150V (10- 15V/cm)
	Current	10 - 15mA
	Time	1.5 - 2h
Snap-lock Connectors for Cooling Coil	Inner Diameter	n/a
	Outer Diameter	n/a
Quick-fit Tubing	Inner Diameter	n/a
	Outer Diameter	n/a
Casting Base Silicone Seal Dimensions (W x L x H)	1.7 x 22.5 x 0.8cm	
Power Output Connectors (diameter)	Shrouded, 4mm	
Recommended Power Supplies	Consort EV243	

BENEFITS INCLUDE

- **Twin-plate 20.5 x 10cm (W x H) wide format mini-gel unit** - designed specifically for PAGE techniques requiring self-cast gels
- **Wide format** - 20.5cm gel width effectively allows 2 mini-gels to be run within the same gel
- **Casting base** - included as standard
- **Glass plate stops** - within the newly modified GRM - lock the glass plates firmly into position onto soft silicone gaskets in the casting base to ensure leak-free gel-casting
- **Additional gel casting** - with the optional TV400-MC2 and 2 gel multicasters
- **Float glass plates** - 4mm thick - guarantee uniform gel thickness and even sample migration, and with ground edges to inhibit sample leakage during casting
- **Twin screws** - on each gel-clamp - act in conjunction with a counterbalanced, dovetailed silicone gasket to disperse pressure evenly along the height and breadth of the gel as the screws are tightened
- **Colour coded combs and spacers** - available in 0.75, 1, 1.5 and 2mm thicknesses

Vertical Gel Units

NATIVE PAGE

Native PAGE resolves proteins by their individual charge to mass ratios. For successful application of this technique, samples must be kept at 4°C and all conditions or steps conducive to protein denaturation, such as SDS, excessive sample agitation and heat incubation, should be omitted from the above protocol. Native PAGE is applied in many areas of research: from resolving proteins of identical molecular weight to recovering biologically active proteins from cell lysates.

Making polyacrylamide gels by the tape-casting method

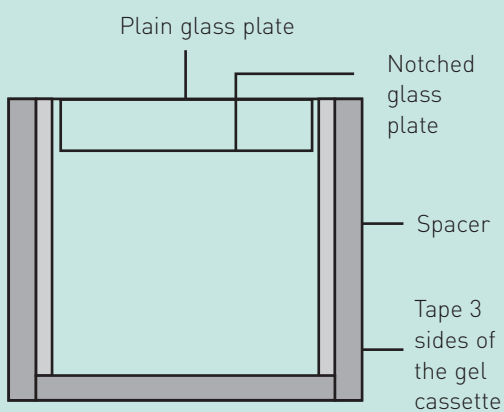

SDS-PAGE METHOD

SDS-PAGE allows proteins to separate on the basis of their molecular weight (MW) and is dependent on the action of SDS - a detergent that equalises the charge to mass ratio of each protein by coating it with a uniform negative charge - and the sieving action of the polyacrylamide gel matrix. This technique is particularly useful for determining the MW of individual protein subunits and as the first step of western blotting to examine the post-translational modification of individual proteins. Scie-Plas recommends using high quality chemicals in the application of this technique and their part numbers are shown (see pages 117-123 for further details).

1. Clean glass plates with distilled water and methanol.
2. Tape 3 sides of each gel cassette to form a leak-free seal and insert into the GRM (see diagram below for tape-cast gels).

3. Prepare and pour a 10% resolving gel as follows for two 10 x 10cm: -

Resolving gel	Part No.
7.5ml 40% (37.5:1) acrylamide	(10681.01)
11.25ml 1M Tris-HCl, pH 8.5	(39794.01)
0.15ml 20% (w/v) SDS	(20767.03)
0.1ml 10% (w/v) APS	(13375.05)
0.02ml TEMED	(35925.01)
11.0ml distilled water	-

4. Overlay distilled water on top of the gel, allowing the gel to set for 30 minutes.

5. Remove the water and prepare and pour a 4.5% stacking gel as follows: -

Stacking gel	Part No.
1.15ml 40% (37.5:1) acrylamide	(10681.01)
1.25ml 1M Tris-HCl, pH 6	(39794.01; to pH 6 with HCl)
0.05ml 20% (w/v) SDS	(20767.03)
0.03ml 10% APS	(13375.05)
0.01ml TEMED	(35925.01)
7.5ml distilled water	-

6. Insert the comb and allow the gel to set.
7. Mix the protein samples with Tris-Glycine/SDS sample buffer (2x) buffer (Tris/HCl pH 6, 126mM, glycerol 20%, SDS 4%, bromophenol blue 0.02%; 42527.01) and denature for 2 minutes at 98°C and then centrifuge for 2 minutes at 14000rpm.
8. Fill the inner buffer chamber and tank with Tris-Glycine/SDS electrophoresis buffer (10x) (0.25M Tris, 1.92M Glycine and 1% SDS; 42529.01).
9. Load the protein samples into the wells according to the well volumes in aqueous solution.
10. Run the gel according to the operating guidelines in Technical Information.
11. After electrophoresis, turn off the power supply and remove the GRM from the tank after emptying it of buffer.
12. Remove the plates from the GRM and gently prise them open with a spacer at a corner but NOT at the notched ears - the gel is now ready for the next application e.g. Western Transfer, staining etc.

Glass plate stops -

serve as an immovable barrier, locking the glass plates firmly into position on the casting base

Twin screws -

act, as they are tightened, with a silicone dovetailed gasket to apply an even pressure across the height and breadth of the gel to prevent the inner gel chamber from leaking

Casting base -

re-engineered with deeper recesses to accommodate soft silicone seals which sit flush with the bottom of each glass plate

Dovetailed silicone gasket -

forms a leak-free seal between the inner GRM and gel tank, making it ideal for discontinuous PAGE

Silicone seals - form a leak-free seal as the glass plates are dragged onto the casting base

Cam pins - turned clockwise to drag the glass plates firmly onto the silicone seals within the casting base

Complete System

Twin-plate wide format mini-gel unit with GRM and gel tank, lid, 2 x (20.5 x 10cm; W x H) plain glass plates, 4 x 1mm spacers, 2 x spacer aligners, 2 x (20.5 x 10cm) notched glass plates, 1 x dummy plate and 2 x 1mm thick 24-sample combs

Part No.



TV200

Twin-plate wide format mini-gel unit with GRM and gel tank, lid, 2 x (20.5 x 10cm; W x H) plain glass plates, 4 x 1mm spacers, 2 x spacer aligners, 2 x (20.5 x 10cm) notched glass plates, 1 x dummy plate, 2 x 1mm thick 24-sample combs, casting base and 2 x silicone seals



TV200Y

Replacement Parts & Accessories

1 x TV200 gel-running module	TV200-GRM
2 x (20.5 x 10cm) plain glass plates with 0.75mm bonded spacers for TV200	TV200-PGS0.75
2 x (20.5 x 10cm) plain glass plates with 1mm bonded spacers for TV200	TV200-PGS1
2 x (20.5 x 10cm) plain glass plates with 1.5mm bonded spacers for TV200	TV200-PGS1.5
2 x (20.5 x 10cm) plain glass plates with 2mm bonded spacers for TV200	TV200-PGS2
2 x (20.5 x 10cm) plain glass plates for TV200	TV200-PG
2 x (20.5 x 10cm) notched glass plates for TV200	TV200-NG
1 x (20.5 x 10cm) dummy plate	TV200-DP
2 x 0.75mm thick spacers for TV200	TV200-S0.75
2 x 1mm thick spacers for TV200	TV200-S1
2 x 1.5mm thick spacers for TV200	TV200-S1.5
2 x spacer aligners for TV200	TV400-SA
1 x cam-pin casting base with 2 silicone seals	TV400-CB
2 x silicone seals for cam-pin casting base	TV400-CB-SEALS
1 x caster system for 2 x (20.5 x 10cm) gradient wide format mini-gels	TV200-MC2
2 x 0.2mm thick, platinum electrode wire	PT-0.2
2 x 1 metre power leads with shrouded 4mm power output connectors	CABLE-4

TV200 Combs

Part No.	Thickness (mm)	Sample Throughput	Tooth Width (mm)	Tooth Height (mm)	Max. Spacing (mm)	Sample Volume / Well (µl)
TV400-C0.35-24	0.35	24	4.75	5	2	8
*TV400-C0.35-36MC	0.35	36	2.5	5	2	4
*TV400-C0.75-18MC	0.75	18	6	20	3	90
TV400-C0.75-24	0.75	24	4.75	20	2	71
*TV400-C0.75-36MC	0.75	36	2.5	20	2	37
TV400-C0.75-48	0.75	48	2.35	20	1	35
*TV400-C1-18MC	1	18	6	20	3	120
TV400-C1-24	1	24	4.75	20	2	95
*TV400-C1-36MC	1	36	2.5	20	2	50
TV400-C1-48	1	48	2.35	20	1	47
*TV400-C1.5-18MC	1.5	18	6	20	3	180
TV400-C1.5-24	1.5	24	4.75	20	2	142
*TV400-C1.5-36MC	1.5	36	2.5	20	2	75
TV400-C1.5-48	1.5	48	2.35	20	1	70

*Multi-channel compatible

Vertical Gel Units

BENEFITS INCLUDE

- **Twin-plate 20.5 x 20cm maxi-gel unit** - designed specifically for higher resolution PAGE techniques requiring self-cast gels
- **Large format** - 20.5 x 20cm glass plate dimensions are ideal for running higher percentage polyacrylamide gels to resolve smaller proteins of similar MW
- **Two versions available:** -
 - Standard TV400 - non-cooled
 - Cooled TV400K - includes a cooling coil in the bottom of the gel tank
- **Enhanced cooling** - in the TV400K - snap-lock connectors allow the cooling coil within TV400K to be connected to an external chiller unit for faster, higher voltage separations
- **Additional gel casting** - with the optional TV400-CB cam-pin casting base or TV400-MC2 and 2 gel multicaster
- **Float glass plates** - 4mm thick - guarantee uniform gel thickness and even sample migration, and with ground edges to inhibit sample leakage during casting
- **Triple screws** - on each gel-clamp - act in conjunction with a counterbalanced, dovetailed silicone gasket to disperse pressure evenly along the height and breadth of the gel as the screws are tightened
- **Colour-coded combs and spacers** - available in 0.75, 1, 1.5 and 2mm thicknesses

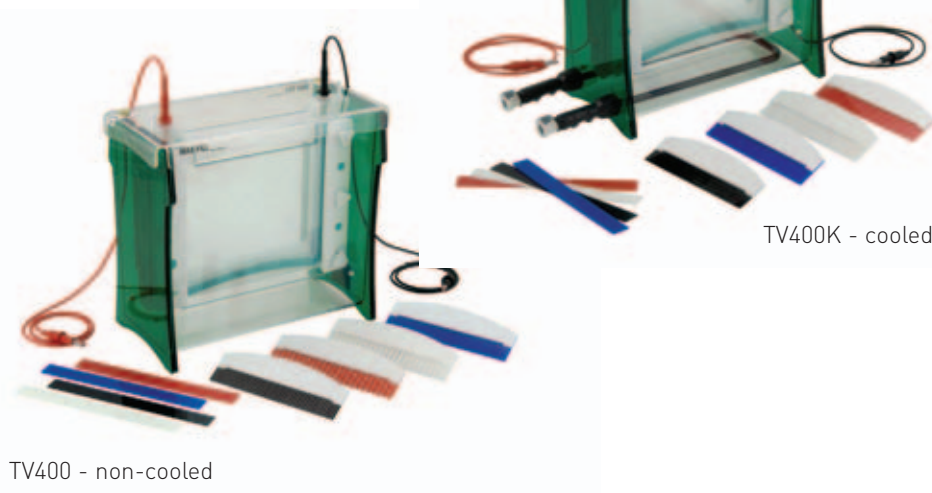

TV400 - non-cooled

TV400K - cooled

TV400 Standard & TV400K Cooled Twin-Plate Maxi-Gel Electrophoresis Units

The TV400 and TV400K twin-plate 20.5 x 20cm (W x H) maxi-gel units offer all the benefits of the TV100 and TV200 units, but in a much larger gel size and with increased sample throughput. A cooling coil within the TV400K gel tank allows faster separations to be performed at high voltage without compromising resolution.

TECHNICAL SPECIFICATION

	TV400	TV400K
Unit Dimensions (W x D x H)	28.5 x 15 x 27.5cm	38 x 15 x 27.5cm
Inner Tank Dimensions (W x D x H)	27 x 12.5 x 25cm	27 x 12.5 x 25cm
Plate Dimensions (W x H x T)	20.5 x 20 x 0.4cm	20.5 x 20 x 0.4cm
Standard Spacer Dimensions (W x H x T)	2 x 20 x 0.1cm	2 x 20 x 0.1cm
Active Gel Dimensions (W x H)	16.5 x 17.5cm	16.5 x 17.5cm
Maximum Sample Capacity	2 x 48	2 x 48
Recommended Buffer Volume	Inner Buffer Chamber 700ml Gel Tank 4200ml	Inner Buffer Chamber 700ml Gel Tank 4200ml
Recommended Running Conditions for Denaturing/Native PAGE Gel	Voltage 175 - 225V (8.75 - 11.25V/cm) Current 20 - 30mA Time 2.5 - 3.5h	Voltage 200 - 300V (10 - 15V/cm) Current 30 - 40mA Time 2 - 2.5h
Snap-lock Connectors for Cooling Coil	Inner Diameter n/a Outer Diameter n/a	Inner Diameter 10mm Outer Diameter 12mm
Quick-fit Tubing	Inner Diameter n/a Outer Diameter n/a	Inner Diameter 10mm Outer Diameter 12mm
Power Output Connectors (diameter)	Shrouded, 4mm	Shrouded, 4mm
Recommended Power Supply	Consort EV243	Consort EV243

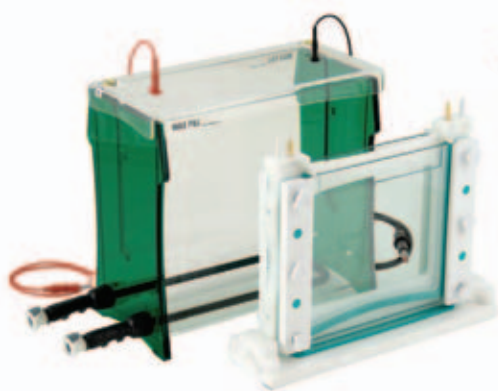

TV400YK - cooled + casting

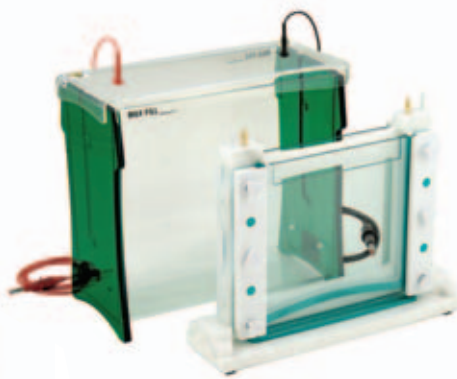

TV400Y - non-cooled + casting

TV400Y Standard & TV400YK Cooled Twin-Plate Maxi-Gel Electrophoresis Units

The TV400Y and TV400YK twin-plate 20.5 x 20cm (W x H) maxi-gel units offers all the benefits of the TV100 and TV200 units, but in a much larger gel size and with increased sample throughput. Both units include, as standard, a precision engineered casting base, which acts in tandem with our recently modified TV400-GRM to provide simple, leak-free casting.

TECHNICAL SPECIFICATION

	TV400Y	TV400YK
Unit Dimensions (W x D x H)	28.5 x 15 x 27.5cm	38 x 15 x 27.5cm
Inner Tank Dimensions (W x D x H)	27 x 12.5 x 25cm	27 x 12.5 x 25cm
Plate Dimensions (W x H x T)	20.5 x 20 x 0.4cm	20.5 x 20 x 0.4cm
Standard Spacer Dimensions (W x H x T)	2 x 20 x 0.1cm	2 x 20 x 0.1cm
Active Gel Dimensions (W x H)	16.5 x 17.5cm	16.5 x 17.5cm
Maximum Sample Capacity	2 x 48	2 x 48
Recommended Buffer Volume	Inner Buffer Chamber	700ml
	Gel Tank	4200ml
Recommended Running Conditions for Denaturing/Native PAGE Gel	Voltage	175 - 225V
		(8.75 - 11.25V/cm)
	Current	20 - 30mA
	Time	2.5 - 3.5h
Snap-lock Connectors for Cooling Coil	Inner Diameter	n/a
	Outer Diameter	n/a
Quick-fit Tubing	Inner Diameter	n/a
	Outer Diameter	n/a
Casting Base Silicone Seal Dimensions (W x L x H)	1.7 x 22.5 x 0.8cm	1.7 x 22.5 x 0.8cm
Power Output Connectors (diameter)	Shrouded, 4mm	Shrouded, 4mm
Recommended Power Supply	Consort EV243	Consort EV243

BENEFITS INCLUDE

- **Twin-plate 20.5 x 20cm maxi-gel unit** - designed specifically for higher resolution PAGE techniques requiring self-cast gels
- **Large format** - 20.5 x 20cm glass plate dimensions are ideal for running higher percentage polyacrylamide gels to resolve smaller proteins of similar molecular weight
- **Casting base** - included as standard with both units
- **Two versions available:** -
Standard TV400Y - non-cooled + casting
Cooled TV400YK - cooled + casting
- **Glass plate stops** - within the newly modified GRM - lock the glass plates firmly into position onto soft silicone gaskets in the casting base to ensure leak-free gel-casting
- **Enhanced cooling** - in the TV400YK - snap-lock connectors allow the cooling coil within TV400YK to be connected to an external chiller unit for faster, higher voltage separations
- **Additional gel casting** - with the optional TV400-MC2 and 2 gel multicaster
- **Float glass plates** - 4mm thick - guarantee uniform gel thickness and even sample migration, and with ground edges to inhibit sample leakage during casting
- **Triple screws** - on each gel-clamp - act in conjunction with a counterbalanced, dovetailed silicone gasket to disperse pressure evenly along the height and breadth of the gel as the screws are tightened
- **Colour-coded combs and spacers** - available in 0.75, 1, 1.5 and 2mm thicknesses

Complete System

Twin-plate wide format mini-gel unit with GRM and gel tank, lid, 2 x (20.5 x 20cm; W x H) plain glass plates, 4 x 1mm spacers, 2 x spacer aligners, 2 x (20.5 x 20cm) notched glass plates, 1 x dummy plate and 2 x 1mm thick 24-sample combs



Twin-plate wide format mini-gel unit with GRM and cooled gel tank, with built-in cooling coil and quick-fit tubing, plus lid, 2 x (20.5 x 20cm; W x H) plain glass plates, 4 x 1mm spacers, 2 x spacer aligners, 2 x (20.5 x 20cm) notched glass plates, 1 x dummy plate and 2 x 1mm thick 24-sample combs



Twin-plate wide format mini-gel unit with GRM and gel tank, lid, 2 x (20.5 x 20cm; W x H) plain glass plates, 4 x 1mm spacers, 2 x spacer aligners 2 x (20.5 x 20cm) notched glass plates, 1 x dummy plate, 2 x 1mm thick 24-sample combs, casting base and 2 x silicone seals



Twin-plate wide format mini-gel unit with GRM and cooled gel tank, with built-in cooling coil and quick-fit tubing, plus lid, 2 x (20.5 x 20cm; W x H) plain glass plates, 4 x 1mm spacers, 2 x spacer aligners, 2 x (20.5 x 20cm) notched glass plates, 1 x dummy plate, 2 x 1mm thick 24-sample combs, casting base and 2 x silicone seals



Replacement Parts & Accessories

1 x TV400 gel-running module	TV400-GRM
2 x quick-fit tubes for cooling coil	TCS-CC
2 x (20.5 x 20cm) plain glass plates with 0.75mm bonded spacers for TV400	TV400-PGS0.75
2 x (20.5 x 20cm) plain glass plates with 1mm bonded spacers for TV400	TV400-PGS1
2 x (20.5 x 20cm) plain glass plates with 1.5mm bonded spacers for TV400	TV400-PGS1.5
2 x (20.5 x 20cm) plain glass plates with 2mm bonded spacers for TV400	TV400-PGS2
2 x (20.5 x 20cm) plain glass plates for TV400	TV400-PG
2 x (20.5 x 20cm) notched glass plates for TV400	TV400-NG
1 x (20.5 x 20cm) dummy plate	TV400-DP
2 x 0.75mm thick spacers for TV400	TV400-S0.75
2 x 1mm thick spacers for TV400	TV400-S1
2 x 1.5mm thick spacers for TV400	TV400-S1.5
2 x 2mm thick spacers for TV400	TV400-S2
2 x spacer aligners for TV400	TV400-SA
1 x cam-pin casting base with 2 silicone seals	TV400-CB
2 x silicone seals for cam-pin casting base	TV400-CB-SEALS
1 x caster system for 2 x (20.5 x 20cm) gradient wide format mini-gels	TV400-MC2
2 x 0.2mm thick, platinum electrode wire	PT-0.2100CM
2 x 1 metre power leads with shrouded 4mm power output connectors	CABLE-4

TV400 Combs

Part No.	Thickness (mm)	Sample Throughput	Tooth Width (mm)	Tooth Height (mm)	Max. Spacing (mm)	Sample Volume / Well (µl)
TV400-C0.35-24	0.35	24	4.75	5	2	8
*TV400-C0.35-36MC	0.35	36	2.5	5	2	4
*TV400-C0.75-18MC	0.75	18	6	20	3	90
TV400-C0.75-24	0.75	24	4.75	20	2	71
*TV400-C0.75-36MC	0.75	36	2.5	20	2	37
TV400-C0.75-48	0.75	48	2.35	20	1	35
*TV400-C1-18MC	1	18	6	20	3	120
TV400-C1-24	1	24	4.75	20	2	95
*TV400-C1-36MC	1	36	2.5	20	2	50
TV400-C1-48	1	48	2.35	20	1	47
*TV400-C1.5-18MC	1.5	18	6	20	3	180
TV400-C1.5-24	1.5	24	4.75	20	2	142
*TV400-C1.5-36MC	1.5	36	2.5	20	2	75
TV400-C1.5-48	1.5	48	2.35	20	1	70

*Multi-channel compatible

DO YOU NEED...?

ACRYLAMIDE	SEE PAGE 118
A CAPILLARY GEL-RUNNING MODULE	SEE PAGE 60
A GEL DOCUMENTATION SYSTEM	SEE PAGE 96
A MULTICASTER	SEE PAGE 80
A GRADIENT MIXER	SEE PAGE 79

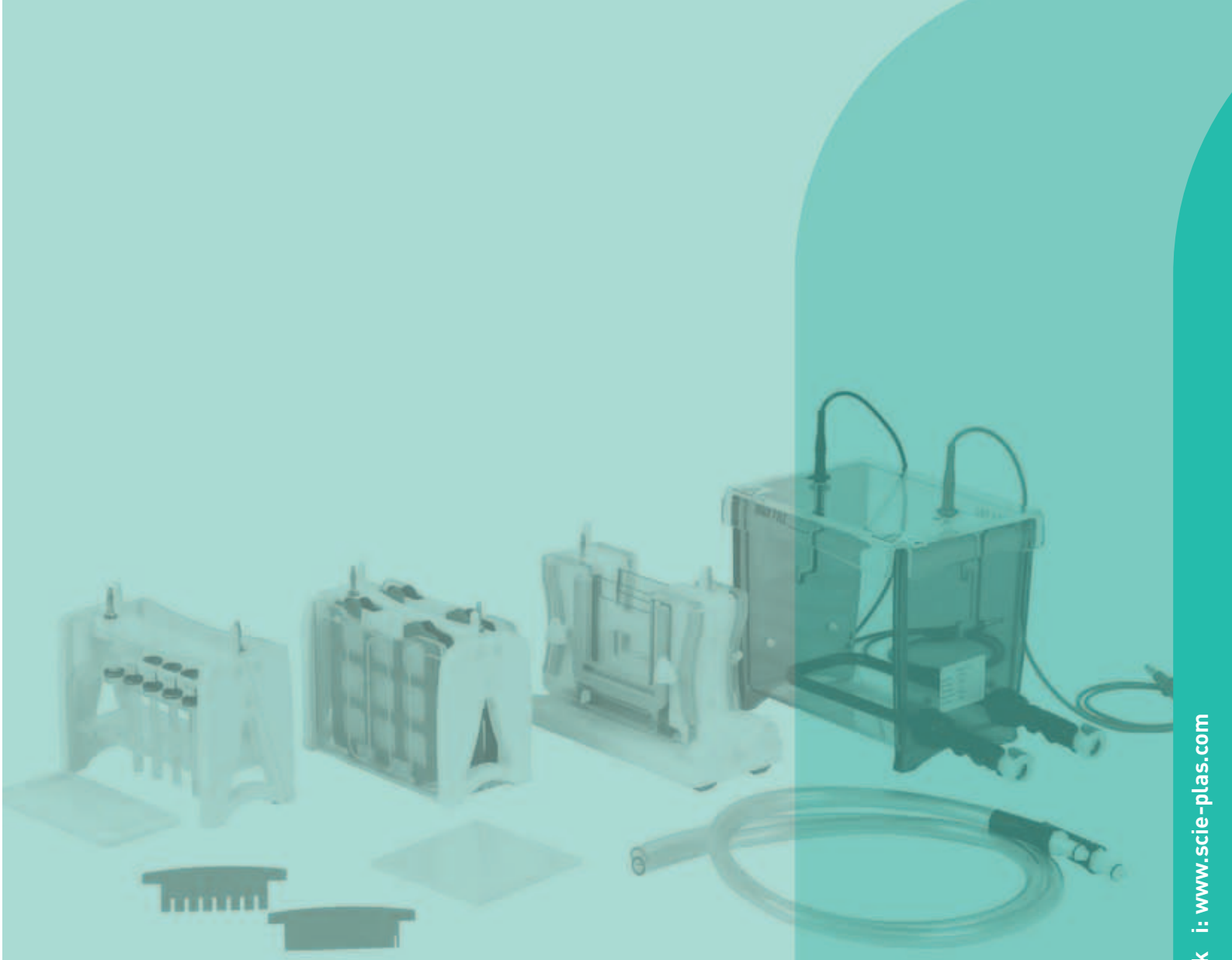

TV Modular Systems

BENEFITS INCLUDE

- **Comprises** - one standard GRM, one CAPGRM and one EBGRM, which are interchangeable within the same gel tank, allowing the user to perform PAGE, IEF and electroblotting either independently or as part of a fully integrated system
- **CAPGRM** (capillary gel running module) - for first dimension electrophoresis of up to 10 ampholyte capillary gels, a maximum 8 or 17cm in length and 1 or 4mm in internal diameter
- **Twin-plate standard GRM** - designed specifically for SDS-PAGE techniques requiring self-cast gels, although commercially available 10 x 10cm precast gels may be used in the TV100-GRM
- **Twin-cassette EBGRM** (Electroblotting Gel Running Module) - allows simultaneous transfer of 2 polyacrylamide gels in colour-coded electroblotting cassettes, while plate-electrodes only 6cm apart maximise the intensity of the electric field
- **Casting base and cooling** - included as standard - act in tandem with glass plate stops within the GRM to lock the plates firmly in position on the casting base, whereas snap-lock connectors allow the cooling coil within the tank to be connected to an external chiller unit for high voltage/current separations
- **Colour-coded combs and spacers** - available in 1 and 1.5mm thicknesses
- **Nitrocellulose and PVDF membranes available plus 10 x 10cm precast gels, ampholytes, 2-D and PAGE chemicals** - see page 118-124 for further details

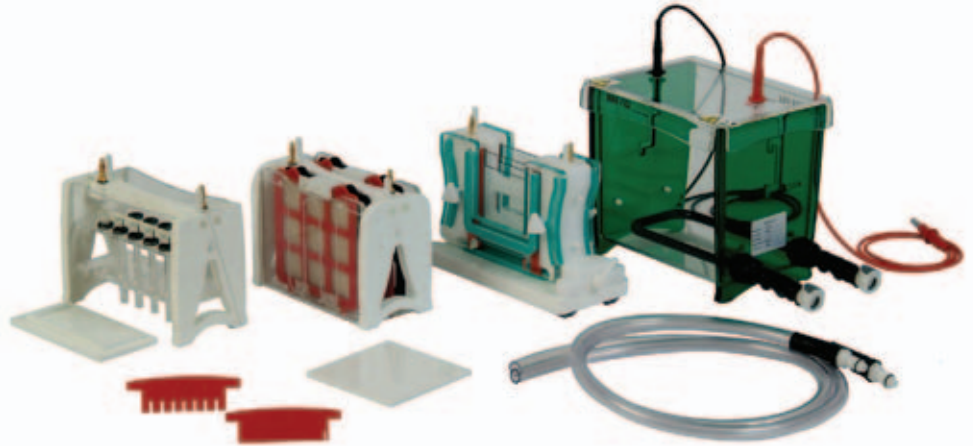

TV Complete Modular Systems

The TV complete modular systems provide a fully integrated solution within one gel tank for both two-dimensional (2-D) electrophoresis and electroblotting. These systems are available in existing TV100 and TV400 formats and comprise individual gel-running modules designed specifically for denaturing or native PAGE (GRM), capillary gel isoelectric focusing (CAPGRM) and electroblotting (EBGRM). Following 2-D electrophoresis, the EBGRM can be used to transfer second dimension SDS-PAGE gels for further analysis by western blotting, providing enhanced sensitivity.

TECHNICAL SPECIFICATION

	TV100YK-MODSYS			TV400YK-MODSYS			
Unit Dimensions (W x D x H)	28 x 15 x 18cm			38 x 15 x 27.5cm			
Inner Tank Dimensions (W x D x H)	16.5 x 11 x 15cm			27 x 12.5 x 25cm			
Plate Dimensions (W x H x T)	10 x 10 x 0.2cm			20.5 x 20 x 0.4cm			
Standard Spacer Dimensions (W x H x T)	1 x 10 x 0.1cm			2 x 20 x 0.1cm			
Active Gel Dimensions (W x H)	8 x 8.5cm			16.5 x 17.5cm			
Sample Capacity	2 x 1 / 2 x 12			2 x 1 / 2 x 24			
Recommended Buffer Volume (PAGE GRM)	Inner Buffer Chamber	90ml		700ml			
	Gel Tank	1600ml		4200ml			
Recommended Running Conditions for SDS-PAGE	Voltage	100 - 150V (10 - 15V/cm)		200 - 300V (10 - 15V/cm)			
	Current	10 - 15mA		30 - 40mA			
	Time	1 - 1.75h		2 - 2.5h			
Capillary Dimensions	Inner Diameter	1mm		1mm			
	Outer Diameter	5mm		5mm			
	Length	80mm		170mm			
Recommended Buffer Volume (CAPGRM)	Upper Buffer Chamber	200ml		300ml			
	Gel Tank	1600ml		4200ml			
Recommended Running Conditions for IEF of Capillary Gels		Pre-run	Separation	End of Run	Pre-run	Separation	End of Run
	Voltage	200V	400V	500V	200V	400V	500V
	Time	0.5h	3h	0.5h	0.5h	6h to 18h	0.5h
	Volt-hours	100Vh	1200Vh	250Vh	100Vh	2400 - 7200Vh	250Vh
Distance Between Plate Electrodes in EBGRM	6cm			6cm			
Electroblotting Cassette Dimensions (W x L)	11.5 x 10.5cm			20.5 x 20cm			
Active Transfer Area	71cm ²			289cm ²			
Recommended Running Conditions for Electroblotting	Voltage	100V		200V			
	Current	75mA (0.6-0.8mA/cm ²)		150mA (0.8-1.0mA/cm ²)			
	Time	4 - 6h		6h to overnight			
Snap-lock Connectors for Cooling Coil	Inner Diameter	10mm		10mm			
	Outer Diameter	12mm		12mm			
Quick-fit Tubing	Inner Diameter	10mm		10mm			
	Outer Diameter	12mm		12mm			
Casting Base Silicone Seal Dimensions (W x L x H)	1.5 x 11 x 0.8cm			1.7 x 22.5 x 0.8cm			
Power Output Connectors (diameter)	Shrouded, 4mm			Shrouded, 4mm			
Recommended Power Supplies	Consort EV215 or EV261			Consort EV215 or EV261			

ORDERING INFORMATION

Complete System

Twin-plate mini-gel unit with GRM and cooled gel tank, with built-in cooling coil and quick-fit tubing, lid, 2 x (10 x 10cm; W x H) plain glass plates, 2 x (10 x 10cm) notched glass plates, 1 x dummy plate, 4 x 1mm thick spacers, 2 x spacer aligners and 2 x 1mm thick 12-sample combs, casting base and 2 x silicone seals; CAPGRM, 10 x 1mm glass capillaries, 4 x 1.5mm thick spacers, 2 x 1.5mm thick 1-D preparatory combs, 10 x blanking ports and 1 x gel extraction platform; plus EBGRM, 2 x electroblotting cassettes and 4 x fibre pads

Part No.



TV100YK-MODSYS

Twin-plate maxi-gel unit with GRM and cooled gel tank, with built-in cooling coil and quick-fit tubing, lid, 2 x (20.5 x 20cm; W x H) plain glass plates, 2 x (20.5 x 20cm) notched glass plates, 1 x dummy plate, 4 x 1mm thick spacers, 2 x spacer aligners and 2 x 1mm thick 24-sample combs, casting base and 2 x silicone seals; CAPGRM, 10 x 1mm glass capillaries, 4 x 1.5mm thick spacers, 2 x 1.5mm thick 1-D preparatory combs, 10 x blanking ports and 1 x gel extraction platform; plus EBGRM, 2 x electroblotting cassettes and 4 x fibre pads



TV400YK-MODSYS

Vertical Gel Units

BENEFITS INCLUDE

- **Comprises** - one standard GRM and one EBGRM, which are interchangeable within the same gel tank, allowing the user either to perform electroblotting independently or as part of a fully integrated system
- **Twin-cassette EBGRM** - available in 2 sizes to allow simultaneous transfer of 2 polyacrylamide gels



- **Plate-electrodes** - only 6cm apart - maximise the intensity of the electric field, allowing rapid transfer in as little as 1 hour
- **Colour-coded electroblotting cassettes** - corresponding to the anode and cathode - ensure that transfer is performed in the correct orientation, while fibre pads compress the gel against the membrane for uniform transfer
- **Twin-plate standard GRM** - designed specifically for SDS-PAGE techniques requiring self-cast gels, although commercially available 10 x 10cm precast gels may be used in the TV100-GRM
- **Casting base and cooling** - included as standard - act in tandem with glass plate stops within the GRM to lock the plates firmly in position on the casting base, whereas snap-lock connectors allow the cooling coil within the tank to be connected to an external chiller unit for high voltage/current separations
- **Colour-coded combs and spacers** - available in 1mm thickness
- **Nitrocellulose and PVDF membranes available plus 10 x 10cm precast gels and blotting buffers** - see pages 118-124 for further details

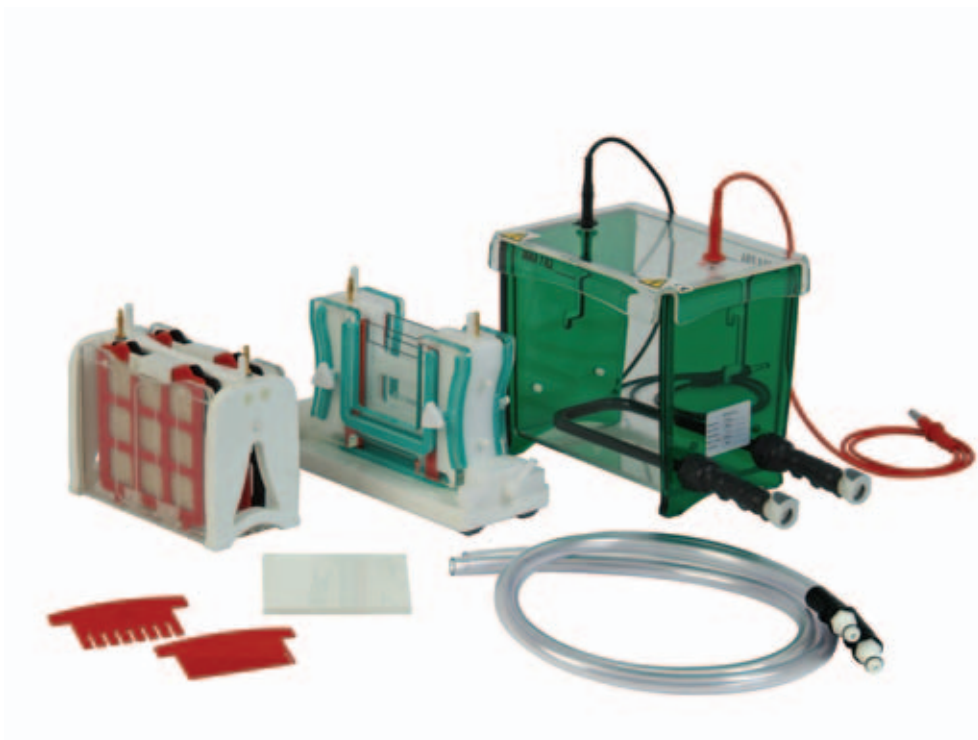

TV Modular Electroblotting Systems

The TV modular electroblotting systems provide a complete solution within one gel tank for PAGE and electroblotting. These systems are available in existing TV100 and TV400 formats, and comprise individual gel-running modules designed specifically for PAGE (GRM) and electroblotting (EBGRM).

TECHNICAL SPECIFICATION

		TV100YK-EBSYS	TV400YK-EBSYS
Unit Dimensions (W x D x H)		28 x 15 x 18cm	38 x 15 x 27.5cm
Inner Tank Dimensions (W x D x H)		16.5 x 11 x 15cm	27 x 12.5 x 25cm
Plate Dimensions (W x H x T)		10 x 10 x 0.2cm	20.5 x 20 x 0.4cm
Standard Spacer Dimensions (W x H x T)		1 x 10 x 0.1cm	2 x 20 x 0.1cm
Active Gel Dimensions (W x H)		8 x 8.5cm	16.5 x 17.5cm
Sample Capacity		2 x 12	2 x 24
Recommended Buffer Volume (PAGE GRM)	Inner Buffer Chamber	90ml	700ml
	Gel Tank	1600ml	4200ml
Recommended Running Conditions for SDS-PAGE	Voltage	100 - 150V (10 - 15V/cm)	200 - 300V (10 - 15V/cm)
	Current	10 - 15mA	30 - 40mA
	Time	1 - 1.75h	2 - 2.5h
Distance Between Plate Electrodes in EBGRM		6cm	6cm
Electroblotting Cassette Dimensions (W x L)		11.5 x 10.5cm	20.5 x 20cm
Active Transfer Area		71cm ²	289cm ²
Recommended Running Conditions for Electroblotting	Voltage	100V	200V
	Current	75mA (0.6-0.8mA/cm ²)	150mA (0.8-1.0mA/cm ²)
	Time	4 - 6h	6h to overnight
Snap-lock Connectors for Cooling Coil	Inner Diameter	10mm	10mm
	Outer Diameter	12mm	12mm
Quick-fit Tubing	Inner Diameter	10mm	10mm
	Outer Diameter	12mm	12mm
Casting Base Silicone Seal Dimensions (W x L x H)		1.5 x 11 x 0.8cm	1.7 x 22.5 x 0.8cm
Power Output Connectors (diameter)		Shrouded, 4mm	Shrouded, 4mm
Recommended Power Supplies		Consort EV215 or EV261	Consort EV215 or EV261

ORDERING INFORMATION

Complete System

Twin-plate mini-gel unit with GRM and cooled gel tank, with built-in cooling coil and quick-fit tubing, lid, 2 x (10 x 10cm; W x H) plain glass plates, 2 x (10 x 10cm) notched glass plates, 1 x dummy plate, 4 x 1mm thick spacers, 2 x spacer aligners and 2 x 1mm thick 12-sample combs, casting base and 2 x silicone seals; plus EBGRM, 2 x electroblotting cassettes and 4 x fibre pads

Part No.



TV100YK-EBSYS

Twin-plate maxi-gel unit with GRM and cooled gel tank, with built-in cooling coil and quick-fit tubing, lid, 2 x (20.5 x 20cm; W x H) plain glass plates, 2 x (20.5 x 20cm) notched glass plates, 1 x dummy plate, 4 x 1mm thick spacers, 2 x spacer aligners and 2 x 1mm thick 24-sample combs, casting base and 2 x silicone seals; plus EBGRM, 2 x electroblotting cassettes and 4 x fibre pads



TV400YK-EBSYS

Vertical Gel Units

BENEFITS INCLUDE

- **Comprises** - one standard GRM and one CAPGRM, which are interchangeable within the same gel tank, allowing the user either to perform PAGE and IEF independently or as part of a fully integrated 2-D system
- **CAPGRM** - available in 2 sizes for first dimension electrophoresis of up to 10 ampholyte capillary gels, a maximum 8 or 17cm in length and 1 or 4mm in internal diameter

TV400-CAPGRM



TV100-CAPGRM

- **Capillary gels** - available in standard 1mm internal diameter for analytical IEF, or as optional 4mm capillaries for protein isolation
- **Gel extraction platform (GEP)** - for safe and easy collection and transfer of fragile, extruded capillary gels
- **Twin-plate standard GRM** - designed specifically for SDS-PAGE techniques requiring self-cast gels, although commercially available 10 x 10cm precast gels may be used in the TV100-GRM
- **Casting base and cooling** - included as standard - act in tandem with glass plate stops within the GRM to lock the plates firmly in position on the casting base, whereas snap-lock connectors allow the cooling coil within the tank to be connected to an external chiller unit for high voltage/current separations
- **Colour-coded combs and spacers** - available in 1 and 1.5mm thicknesses, the latter suited to 1.5mm thick capillary gels for second dimension 2-D electrophoresis
- **Ampholytes, 2-D and PAGE chemicals available** - see pages 118-124 for further details

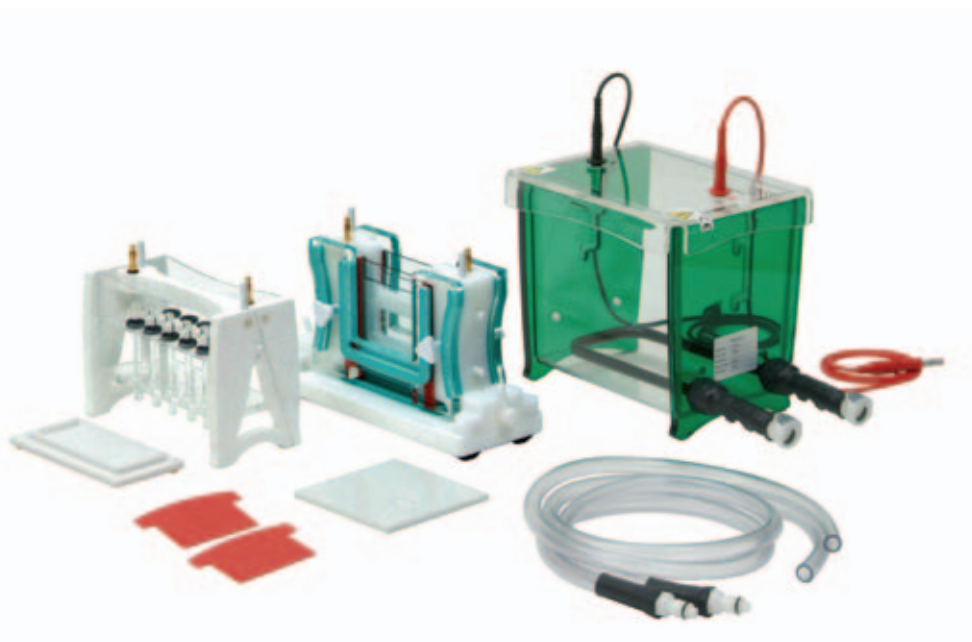

TV Modular 2-D Systems

The TV modular 2-D systems provide a complete solution within one gel tank for two-dimensional (2-D) electrophoresis. These systems are available in existing TV100 and TV400 formats and comprise individual gel-running modules designed specifically for denaturing or native PAGE (GRM) and isoelectric focusing (IEF) with capillary gels (CAPGRM).

TECHNICAL SPECIFICATION

		TV100YK-2DSYS	TV400YK-2DSYS				
Unit Dimensions (W x D x H)		28 x 15 x 18cm	38 x 15 x 27.5cm				
Inner Tank Dimensions (W x D x H)		16.5 x 11 x 15cm	27 x 12.5 x 25cm				
Plate Dimensions (W x H x T)		10 x 10 x 0.2cm	20.5 x 20 x 0.4cm				
Standard Spacer Dimensions (W x H x T)		1 x 10 x 0.1cm	2 x 20 x 0.1cm				
Active Gel Dimensions (W x H)		8 x 8.5cm	16.5 x 17.5cm				
Sample Capacity		2 x 1 / 2 x 12	2 x 1 / 2 x 24				
Recommended Buffer Volume (PAGE GRM)	Inner Buffer Chamber	90ml	700ml				
	Gel Tank	1600ml	4200ml				
Recommended Running Conditions for SDS-PAGE	Voltage	100 - 150V (10 - 15V/cm)	200 - 300V (10 - 15V/cm)				
	Current	10 - 15mA	30 - 40mA				
	Time	1 - 1.75h	2 - 2.5h				
Capillary Dimensions	Inner Diameter	1mm	1mm				
	Outer Diameter	5mm	5mm				
	Length	80mm	170mm				
Recommended Buffer Volume (CAPGRM)	Upper Buffer Chamber	200ml	200ml				
	Gel Tank	1600ml	1600ml				
Recommended Running Conditions for IEF of Capillary Gels		Pre-run	Separation	End of Run	Pre-run	Separation	End of Run
	Voltage	200V	400V	500V	200V	400V	500V
	Time	0.5h	3h	0.5h	0.5h	6h to 18h	0.5h
	Volt-hours	100Vh	1200Vh	250Vh	100Vh	2400Vh -7200Vh	250Vh
Snap-lock Connectors for Cooling Coil	Inner Diameter	10mm	10mm				
	Outer Diameter	12mm	12mm				
Quick-fit Tubing	Inner Diameter	10mm	10mm				
	Outer Diameter	12mm	12mm				
Casting Base Silicone Seal Dimensions (W x L x H)		1.5 x 11 x 0.8cm	1.7 x 22.5 x 0.8cm				
Power Output Connectors (diameter)		Shrouded, 4mm	Shrouded, 4mm				
Recommended Power Supplies		Consort EV215 or EV261	Consort EV215 or EV261				

ORDERING INFORMATION

Complete System

Twin-plate mini-gel unit with GRM and cooled gel tank, with built-in cooling coil and quick-fit tubing, lid, 2 x (10 x 10cm; W x H) plain glass plates, 2 x (10 x 10cm) notched glass plates, 1 x dummy plate, 4 x 1mm thick spacers, 2 x spacer aligners and 2 x 1mm thick 12-sample combs, casting base and 2 x silicone seals; CAPGRM, 10 x 1mm glass capillaries, 4 x 1.5mm thick spacers, 2 x 1.5mm thick 1-D preparatory combs, 10 x blanking ports and 1 x gel extraction platform

Part No.



TV100YK-2DSYS

Twin-plate maxi-gel unit with GRM and cooled gel tank, with built-in cooling coil and quick-fit tubing, lid, 2 x (20.5 x 20cm; W x H) plain glass plates, 2 x (20.5 x 20cm) notched glass plates, 1 x dummy plate, 4 x 1mm thick spacers, 2 x spacer aligners and 2 x 1mm thick 24-sample combs, casting base and 2 x silicone seals; CAPGRM, 10 x 1mm glass capillaries, 4 x 1.5mm thick spacers, 2 x 1.5mm thick 1-D preparatory combs, 10 x blanking ports and 1 x gel extraction platform



TV400YK-2DSYS

TV Modular Systems Accessories

Replacement Parts & Accessories

Description	TV100YK-MODSYS	TV400YK-MODSYS
	Part No.	Part No.
1 x gel-running module	TV100-GRM	TV400-GRM
2 x quick-fit tubes for cooling coil	TCS-CC	TCS-CC
2 x plain glass plates	TV100-PG	TV400-PG
2 x notched glass plates	TV100-NG	TV400-NG
1 x dummy plate	TV100-DP	TV400-DP
2 x 1mm thick spacers	TV100-S1	TV400-S1
1 x 1mm thick 12-sample combs	TV100-C1-12	-
1 x 1mm thick 24-sample combs	-	TV400-C1-24
2 x spacer aligners	TV100-SA	TV400-SA
1 x cam-pin casting base with 2 silicone seals	TV100-CB	TV400-CB
2 x silicone seals for cam-pin casting base	TV100-CB-SEALS	TV400-CB-SEALS
2 x 0.2mm thick, platinum electrode wire	PT-0.2	PT-0.2
2 x 1 metre power leads with shrouded 4mm power output connectors	CABLE-4	CABLE-4
2 x 1.5mm thick spacers	TV100-S1.5	TV400-S1.5
1 x 1.5mm thick 1-D preparatory combs	TV100-C1-1D	TV400-C1-1D
1 x capillary gel-running module	TV100-CAPGRM	TV400-CAPGRM
10 x 1mm glass capillaries	TV100-CAPROD	TV400-CAPROD
10 x 4mm glass capillaries, ideal for preparatory IEF and protein purification	TV100-CAPROD4	TV400-CAPROD4
10 x blanking ports	TV100-CAPB	TV100-CAPB
1 x gel extraction platform	TV100-GEP	TV400-GEP
1 x electroblotting gel-running module with built-in plate electrodes	TV100-EBGRM	TV400-EBGRM
1 x colour-coded electroblotting cassette	TV100-EBC	TV400-EBC
4 x fibre pads	TV100-FP	TV400-FP

 Use these part numbers when ordering replacement parts for each TV100 and TV400 complete modular MODSYS system

 Use these part numbers when ordering replacement parts for each TV100 and TV400 modular 2DSYS system

 Use these part numbers when ordering replacement parts for each TV100 and TV400 modular EBSYS system



See pages 117-124 for chemicals, reagents and buffers for SDS-PAGE, electroblotting and 2-D capillary gel electrophoresis



See page 124 for Scie-Plas blotting membranes

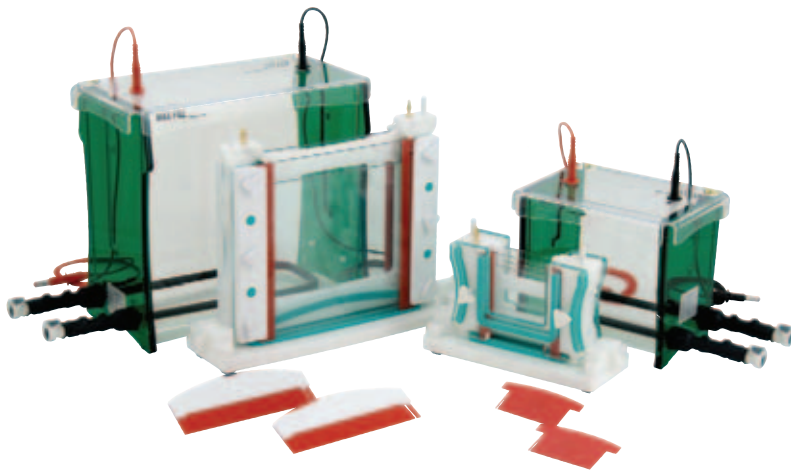

The TV100YK and TV400YK-2D-IEF-SYS Units: Dedicated 2-D Electrophoresis Systems

Scie-Plas now provide the first of a series of innovative solutions for scientists who prefer the latest advances in IPG (immobilised pH gradient) strip technology to more traditional capillary gels as the first step of 2-D electrophoresis. Our recently improved flat-bed isoelectric focusing system (IEF-SYS) allows 1st dimension 2-D electrophoresis to be performed with multiple IPG strips within the same tank, while 2nd dimension SDS-PAGE is carried out in our existing TV100 and 400 Mini- and Maxi-gel formats (TV100YK or TV400YK).

Scie-Plas offer the complete 2-D electrophoresis system with everything you need for running reproducible 2-D gels.

IEF-SYS FOR THE 1ST DIMENSION

A recently redesigned IEF-SYS unit where a maximum of 30 SERVA IPG strips, each 3mm wide and up to 24cm in length, may be run simultaneously on a 27 x 27cm ceramic cooling plate.

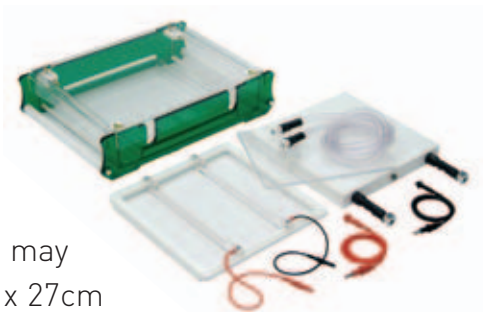

FOR THE 2ND DIMENSION

Either the TV100YK twin-plate 10 x 10cm (W x H) mini-gel unit Or the TV400YK twin-plate 20.5 x 20cm (W x H) maxi-gel unit

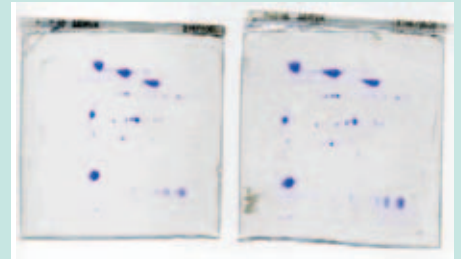

Separation of SERVA proteome markers (39220.01) by 2-D electrophoresis using 18cm long SERVA IPG Bluestrips, pH 3-10, on the IEF-SYS unit in the first dimension, followed by SDS-PAGE in the TV400Y unit in the second dimension. An overview of 2-D electrophoresis is provided in the Outline Protocol, while further details can be found in our 2-D Technical. Manual available from sales@scie-plas.co.uk.

BENEFITS INCLUDE

- **Glass electrode frame** - sits flush with the ceramic cooling plate for optimal cooling efficiency
- **Positive and negative electrodes** - made from clear acrylic clip neatly within a glass electrode frame that allows the voltage gradient to be fine-tuned along the entire length of each IPG strip
- **Glass electrode support slab** - ensures that the electrodes remain in complete contact with the positive and negative ends of each IPG strip during IEF

BENEFITS INCLUDE

- **Casting & cooling included as standard**
- **New-style GRM for leak-free casting**

Adaptable either for 1mm or 1.5mm thick gels in the 2nd dimension

Vertical Gel Units

BENEFITS INCLUDE

- **Nine different program settings** - each with 9 different parameters - allow more complex, multi-step techniques to be programmed and stored, while voltage ramping, automatic crossover and recovery after power failure are included as standard
- **High voltage 3kV output** - allows desired Volt-hours to be attained faster at maximum voltage during IEF resulting in shorter overall run time
- **4/2MMA adaptors** - compatible with the 2mm recessed outputs of the power supply - adapt the 4mm shrouded power connectors of the TV100YK and TV400YK units for lower voltage 2nd dimension SDS-PAGE

See page 92 for further details

BENEFITS INCLUDE

- **Temperature range: -20 to +40°C**
- **Can be easily adjusted to +20°C** - the ideal temperature for running IPG strips
- **Flow rate 15L/min / Maximum pressure 350mbar**

See page 82 for further details

EV232 High-Voltage 3kV Power Supply

The Consort EV232 power supply - 3000V, 150mA, 150W



FL300 Chiller Unit

Maintains cooling plate temperature during IEF



2-D ELECTROPHORESIS: OUTLINE PROTOCOL

1. Incubate the IPG strips overnight in a rehydration tray with buffer (e.g. 8M Urea, 1% CHAPS, 13mM DTT and 0.5% SERVALYT™ 3-10, corresponding to the pH gradient of the IPG strip), overlaid with silicone oil, containing the protein of interest.
2. Connect the ceramic cooling plate of the IEF-SYS to the external chiller preset at 20°C, before placing the glass electrode frame directly on the cooling plate. Apply a thin layer of silicone oil over the glass plate before laying out the IPG strips at least 3mm apart.
3. After covering the anode and cathode ends of the IPG strips with electrode wicks saturated with deionised water, clip each electrode into its respective position within the glass electrode frame, before overlaying the glass electrode weight.
4. Cover the IPG strips with silicone oil to protect them from heat desiccation during IEF.
5. After IEF incubate the IPG strips for 10 minutes in Equilibration Buffer 1 (50mM Tris-HCl, pH 8.8, 6M Urea, 30% glycerol, 2% SDS, 0.01% bromophenol blue and 1% (w/v) DTT) by placing the rehydration tray on to an agitating platform. Repeat this for a further 10 minutes with Equilibration Buffer 2 (50mM Tris-HCl, pH 8.8, 6M Urea, 30% glycerol, 2% SDS, 0.01% bromophenol blue and 5% (w/v) iodoacetamide).
6. Dip each strip briefly in 1 x Laemmli Buffer before aligning it by its 1mm thick edge along the top of a pre-made 10% acrylamide gel.
7. Having covered each strip with 0.5% agarose solution, perform second-dimension SDS-PAGE .

ORDERING INFORMATION

Complete System

TV100YK + IEF-SYS + EV232 + external chiller unit

Twin-plate mini-gel unit with PAGE GRM and cooled gel tank, lid, 2 x (10 x 10cm; W x H) plain glass plates, 2 x (10 x 10cm) notched glass plates, 1 x dummy plate, 4 x 1mm spacers, 4 x 1.5mm spacers, 2 x spacer aligners, 2 x 1mm thick 1-D combs, 2 x 1.5mm thick 1-D combs, casting base, 2 x silicone seals, 1 x dummy plate, 2 x quick-fit tubes, 2 x 4mm power cables and 2 x 4/2mm power output adaptors

Flat-bed isoelectric focusing unit includes running tank, lid, 1 x ceramic cooling plate, 1 x glass plate, electrode frame, 1 x anode electrode, 1 x cathode electrode, 1 x glass electrode weight, 2 x quick-fit tubes and 2 x 2mm power cables

Consort EV232 3000V, 150mA, 150W power supply

Recirculating Chiller

Part No.

TV100YK-2D-IEF-SYS

TV100YK

IEF-SYS

EV232

FL300

Complete System

TV400YK + IEF-SYS + EV232 + external chiller unit

Twin-plate maxi-gel unit with PAGE GRM and cooled gel tank, lid, 2 x (20.5 x 20cm; W x H) plain glass plates, 2 x (20.5 x 20cm) notched glass plates, 1 x dummy plate, 4 x 1mm spacers, 4 x 1.5mm spacers, 2 x spacer aligners, 2 x 1mm thick 1-D combs, 2 x 1.5mm thick 1-D combs, casting base, 2 x silicone seals, 1 x dummy plate, 2 x quick-fit tubes, 2 x 4mm power cables and 2 x 4/2mm power output adaptors

Flat-bed isoelectric focusing unit includes running tank, lid, 1 x ceramic cooling plate, 1 x glass plate, electrode frame, 1 x anode electrode, 1 x cathode electrode, 1 x glass electrode weight, 2 x quick-fit tubes and 2 x 2mm power cables

Consort EV232 3000V, 150mA, 150W power supply

Recirculating Chiller

Part No.

TV400YK-2D-IEF-SYS

TV400YK

IEF-SYS

EV232

FL300

Technical Specification

TV100YK-2D-IEF-SYS / TV400YK-2D-IEF-SYS Units

IEF-SYS (1st dimension IEF)

Maximum Sample Capacity	30 x 7cm IPG strips (dimensions: 70 x 3 x 1mm/L x W x T) - TV100YK-2D-IEF-SYS 30 x 18cm IPG strips (dimensions: 180 x 3 x 1mm/L x W x T) - TV400YK-2D-IEF-SYS						
Unit dimensions (W x D x H)	46 x 41 x 11.5cm						
Inner Tank Dimensions (W x D x H)	37 x 31 x 8.5cm						
Glass Plate Dimensions (W x L x T)	27 x 27 x 0.5cm						
Electrode Frame Dimensions (W x L x T)	27 x 27 x 1cm						
Cooling Plate Dimensions (W x L x T)	27 x 27 x 3cm						
Glass Electrode Weight (W x L x T)	20 x 26.5 x 1cm						
Adjustable Electrodes Active Dimensions (W x L x T)	10 x 265 x 13mm						
Recommended Temperature for Cooling Plate during IEF with IPG strips	20°C						
Power Output Connectors (diameter)	Shrouded, 2mm						
Recommended Running Conditions for IEF of 7cm IPG strips (TV100YK-2D-IEF-SYS)	Voltage Step	1	2	3	4	5	6 end of run
	Voltage (V)	150	300	600	1500	3000	330
	Time (h)	0.5	0.5	0.5	0.5	2.5	<20
	Volt-hours	75	150	300	750	7500	-
Recommended Running Conditions for IEF of 18cm IPG strips (TV400YK-2D-IEF-SYS)	Voltage Step	1	2	3	4	5	end of run
	Voltage (V)	300	600	1500	3000	330	
	Time (h)	1	1	1	12.5	<20	
	Volt-hours	300	600	1500	37500	-	
Snap-lock Connectors for Cooling Coil	Inner Diameter	10mm			Outer Diameter	12mm	
Quick-fit Tubing	Inner Diameter	10mm			Outer Diameter	12mm	

TV100YK (2nd dimension PAGE)

TV400YK (2nd dimension PAGE)

Maximum Sample Capacity	2 x 7cm IPG strips		2 x 18cm IPG strips (trimmed) / 2 x 11cm IPG strips from other commercial sources	
Unit Dimensions (W x D x H)	20 x 15 x 18cm		38 x 15 x 27.5cm	
Inner Tank Dimensions (W x D x H)	16.5 x 11 x 15cm		27 x 12.5 x 25cm	
Plate Dimensions (W x H x T)	10 x 10 x 0.2cm		20.5 x 20 x 0.4cm	
Spacer Dimensions (W x H x T)	1 x 10 x 0.1/0.15cm		2 x 20 x 0.1/0.15cm	
Active Gel Dimensions (W x H)	8 x 8.5cm		16.5 x 17.5cm	
Casting Base Silicone Seal Dimensions (W x L x H)	1.5 x 11 x 0.8cm		1.7 x 22.5 x 0.8cm	
Power Output Connectors (diameter)	Shrouded, 4mm - use 4/2MMA adaptors for EV232 power supply		Shrouded, 4mm - use 4/2MMA adaptors for EV232 power supply	
Recommended Buffer Volume (PAGE GRM)	Inner Buffer Chamber	90ml	Inner Buffer Chamber	700ml
	Gel Tank	1600ml	Gel Tank	4200ml
Recommended Running Conditions for Denaturing PAGE	Voltage	100 - 150V (10 - 15V/cm)	Voltage	200 - 300V (10 - 15V/cm)
	Current	10 - 15mA	Current	30 - 40mA
	Time	1 - 1.75h	Time	2 - 2.5h
Snap-lock Connectors for Cooling Coil	Inner Diameter	10mm	Inner Diameter	10mm
	Outer Diameter	12mm	Outer Diameter	12mm
Quick-fit Tubing	Inner Diameter	10mm	Inner Diameter	10mm
	Outer Diameter	12mm	Outer Diameter	12mm

Vertical Gel Units

BENEFITS INCLUDE

- **Safety lid** - although light weight and easily detachable, the lid cannot be removed during electrophoresis without breaking the electrical circuit
- **Ventilation grille** - aids heat dispersal during electrophoresis and can be replaced by the optional thermostatic fan kit (see FHS-KIT)
- **High voltage power cables** - oriented asymmetrically for correct polar orientation - with 2mm shrouded output connectors that are universally compatible with modern high voltage power supplies
- **Safety handles** - complimented by a new streamlined and light weight design - allow easy transportation around the lab
- **Spring-loaded plate clamps** - act in conjunction with counterbalanced silicone gaskets to maintain uniform gel thickness and even distribution of pressure across the 4mm thick float glass plates
- **Aluminium back plate** - serves as a heat sink to prevent sample distortion and 'smiling'
- **Lower buffer chamber** - clips directly onto the anode and can also be used to drain buffer from the upper chamber
- **Optional FHS-KIT** - an adjustable, thermostatically controlled fan kit powered independently to maintain gel temperature
- **Melinex combs and spacers** - 0.25 and 0.35mm thick - precision machined for maximum loading accuracy and optimum band resolution

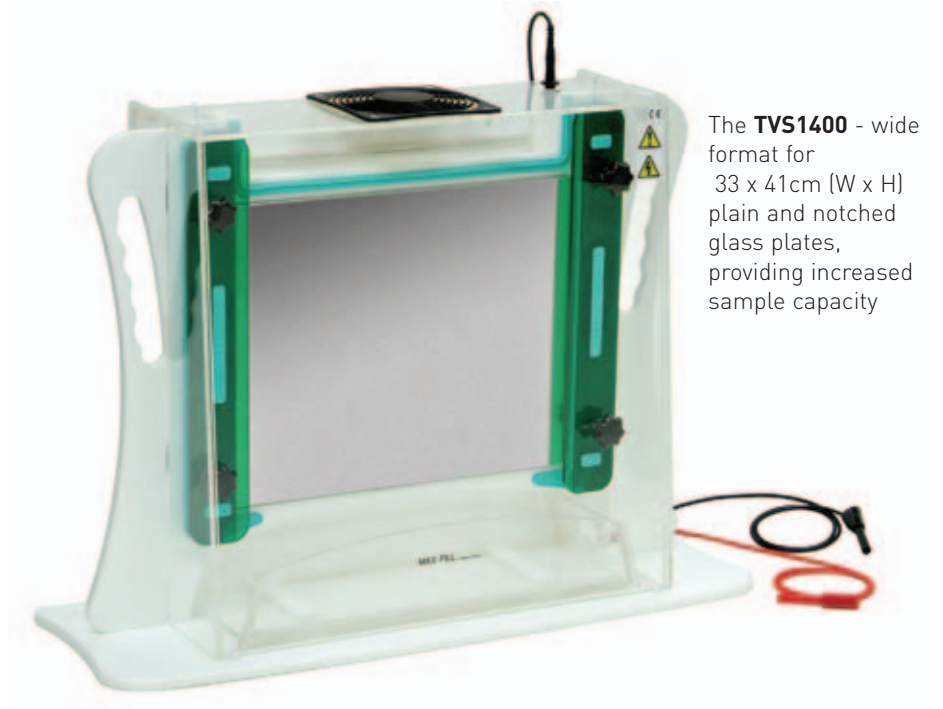

The **TVS1400** - wide format for 33 x 41cm (W x H) plain and notched glass plates, providing increased sample capacity

The TVS1400 Single-Plate Large Format Vertical Gel Electrophoresis Unit

The Scie-Plas single-plate large format vertical gel electrophoresis unit is ideal for high-resolution techniques, such as DNA sequencing, DNase and RNase footprinting, and heteroduplex and oligonucleotide analysis, which require longer separation distances.

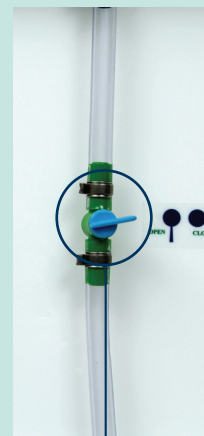

Drainage tap -
allows the upper
buffer chamber
to be emptied
safely and easily

TECHNICAL SPECIFICATION

TVS1400

Unit Dimensions (W x D x H)	63 x 21.5 x 50cm	
Plate Dimensions (W x H x T)	33 x 41 x 0.4cm	
Standard Spacer Dimensions (W x H x T)	10 x 410 x 0.35mm	
Active Gel Dimensions (W x H)	29 x 38.5cm	
Maximum Sample Capacity	1 x 96	
Recommended Buffer Volume	Upper Buffer Chamber	1200ml
	Lower Buffer Chamber	1200ml
Recommended Running Conditions for 6% Denaturing PAGE Gel Using Passive Ventilation at 20°C Ambient Temperature	Power	45 - 55W
	Gel Temperature	50 - 60°C
Recommended Running Conditions for 6% Denaturing PAGE Gel Using FHS-KIT at 20°C Ambient Temperature	Power	75W
	Gel Temperature	55°C
	Time	1.75h
Power Output Connectors (diameter)	Shrouded, 2mm	
Recommended Power Supplies	Consort EV232 & EV233	

Vertical Gel Units

TECHNICAL SPECIFICATION

	FHS-KIT
Unit Dimensions (W x D x H)	9.6 x 14 x 8cm
Temperature Control Range	0 - 100°C
Temperature Control Accuracy	+/-2%
Fan Dimensions (W x D x H)	12 x 12 x 3.8cm
Fan Operating Speed	2700rpm
Flow Rate	>84CFM
Noise Rating	36 dBA

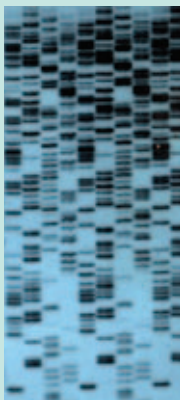

An autoradiograph of a 0.35mm 6% sequencing gel run in 1.75h on a TVS1400 single-plate vertical gel electrophoresis unit, at 75W constant power with the gel temperature maintained at 55°C using the FHS-KIT. Further details on operation of the TVS1400 units can be found in our Technical Manual available from sales@scie-plas.co.uk.



**ELECTROPHORESIS
CHEMICALS
SEE PAGES 117-123**

DO YOU NEED...?

GEL DRYERS
VACUUM PUMP
A POWER SUPPLY
ACRYLAMIDE

SEE PAGE 73
SEE PAGE 75
SEE PAGES 91-92
SEE PAGE 118

Optional FHS-KIT

- Comprises a fan operated by a heat sensor temperature control unit
- Gel temperature is set by manual adjustment of the dial on the front panel of the control unit
- Fan is screwed onto the lid of the TVS1400 in place of the ventilation grille
- Fan is activated within 4°C of the preset temperature
- Separations performed in less than 2 hours at 55°C at 75W constant power



ORDERING INFORMATION

Complete System

Single-plate vertical gel electrophoresis unit with integral GRM and aluminium back plate; upper and lower buffer chambers; lid, 2 x (33 x 41cm; W x H) plain glass plates, 2 x (33 x 41cm) notched glass plates, 2 x 0.35mm melinex spacers and 1 x 0.35mm thick 48-sample shark's tooth melinex comb

Part No.

TVS1400

Replacement Parts & Accessories

2 x (33 x 41cm) plain glass plates for TVS1400	TVS1400-PG
2 x (33 x 41cm) notched glass plates for TVS1400	TVS1400-NG
2 x 0.35mm thick spacers for TVS1400	TVS1400-S0.35

Fan sensor kit including heat sensor temperature control unit, fan and mains power lead for TVS1400 (220-240Va.c.)	FHS-KIT
Fan sensor kit including heat sensor temperature control unit, fan and mains power lead for TVS1400 (100-110Va.c.)	FHS-KIT-A
2 x 0.2mm thick, platinum electrode wire for TVS1400	PT-0.2
2 x 1 metre power leads with shrouded 2mm power output connectors TVS1400	CABLE-2

TVS1400 Combs

Part No.	Thickness (mm)	Sample Throughput	Tooth Width (mm)	Tooth Height (mm)	Max. Spacing (mm)	Sample Volume / Well (µl)
TVS1400-C0.35-40	0.35	40	4	5	3	7
*TVS1400-C0.35-60MC	0.35	60	2	5	2.5	3.5

Shark's Tooth Combs

TVS1400-SC-M0.35-48	0.35	24	3	10	2.8	5
*TVS1400-SC-M0.35-60MC	0.35	60	2.5	10	5.6	4
TVS1400-SC-M0.35-96	0.35	96	2.5	9	4.5	3.5

*Multi-channel compatible

The GD-4534 and GD-5040 Gel Dryers

The GD-4534 and GD-5040 vacuum gel dryers are ideal for drying sequencing gels or multiple small format gels.

A cast-aluminium base, overlaid with a porous stainless steel sheet, evenly distributes the heat generated by an 800-Watt heating element, which is set in increments of +/- 2°C to a maximum temperature of 90°C. Both the heating element and vacuum pump are timer-controlled so that the drying time and vacuum pump can be set in 1-minute increments to a maximum of 5 hours, while each unit is lightweight, despite its robust construction, for easy transportation around the laboratory. Each gel dryer can be either purchased individually or as part of a complete system with the Vacuubrand® gel pump.



TECHNICAL SPECIFICATION

	GD-4534		GD-5040	
Unit Dimensions (W x D x H)	57 x 40 x 11cm		63 x 48 x 12cm	
Active Transfer Area (W x L)	45 x 34cm		50 x 40cm	
Sample Throughput	One 33 x 41cm TVS1400 sequencing gel; fifteen 10 x 10cm mini-gels		Two 20 x 50cm TVS1000 sequencing gels; twenty 10 x 10cm mini-gels	
Timer Range, Vacuum	0-5h		0-5h	
Timer Range, Temperature	0-5h		0-5h	
Temperature Range	Ambient-90°C		Ambient-90°C	
Recommended Drying Conditions	40min at 80°C for ≤1.5mm sequencing gel 2-3 hours at 50°C for >1.5mm agarose gel		40min at 80°C for ≤1.5mm sequencing gel 2-3 hours at 50°C for >1.5mm agarose gel	
Dimensions of Vacuum Port	Internal	External	Internal	External
	8mm	9mm	8mm	9mm
Pore Size of Porous Polyethylene Cover Sheet	0.75mm		0.75mm	
Pore Size of Stainless Steel Sheet	1mm		1mm	
Required Flow Rate of Vacuum Source	25-100L/min		25-100L/min	

BENEFITS INCLUDE

- **2 sizes available:** -
 - GD-4534 - 45 x 34cm (W x L) format - accommodates one TVS1400 gel or up to fifteen 10 x 10cm mini-gels
 - GD-5040 - 50 x 40cm (W x L) format - accommodates up to twenty 10 x 10cm mini-gels
- **Drying assured within 1 hour** - for sequencing gels of dimensions up to 50 x 40cm
- **Accurate temperature control** - in +/- 2°C increments to a maximum of 90°C
- **Accurate timer control** - of the heating element and vacuum pump - in +/- 1 minute increments to a maximum of 5 hours
- **Detachable mylar sheet and porous polyethylene sheet** - allow the gel dryer to be adapted for thin polyacrylamide gels and thicker agarose gels
- **Stainless steel screen** - acts in conjunction with a cast-aluminium base to serve as a porous gel support, uniformly distributing the heat and vacuum to prevent gel cracking during drying
- **Translucent silicone rubber overlay** - allows the gels to be visualised during the drying process
- **Vacuubrand® MZ 2C + 2AK pump available**

For a 110VAC electrical system use codes GD-4534-A & GD-5040-A

Complete System

	Part No.
45 x 34cm (W x L) Slab Gel Dryer System, including stainless steel sheet, mylar sheet, porous polyethylene sheet and clear silicone rubber overlay sheet	GD-4534

Replacement Parts & Accessories

Stainless steel sheet for GD-4534	VGD-SSS
Mylar sheet for GD-4534	VGD-MS
Porous polyethylene sheet for GD-4534	VGD-PPS
Clear silicone rubber overlay sheet for GD-4534	VGD-SRO

Complete System

	Part No.
50 x 40cm (W x L) Slab Gel Dryer System, including stainless steel sheet, mylar sheet, porous polyethylene sheet and clear silicone rubber overlay sheet	GD-5040

Replacement Parts & Accessories

Stainless steel sheet for GD-5040	GD-SSS
Mylar sheet for GD-5040	GD-MS
Porous polyethylene sheet for GD-5040	GD-PPS
Clear silicone rubber overlay sheet for GD-5040	GD-SRO



GD-4534 shown with Vacuubrand MZ 2C+2 AK Vacuum Pump (can be purchased separately)

The Vacuubrand® MZ 2C + 2 AK Vacuum Pump

The Vacuubrand® MZ 2C + 2 AK is a quiet, low maintenance, oil-free diaphragm pump that supplies the low vacuum necessary for fast gel drying with the GD-4534 and GD-5040 units.

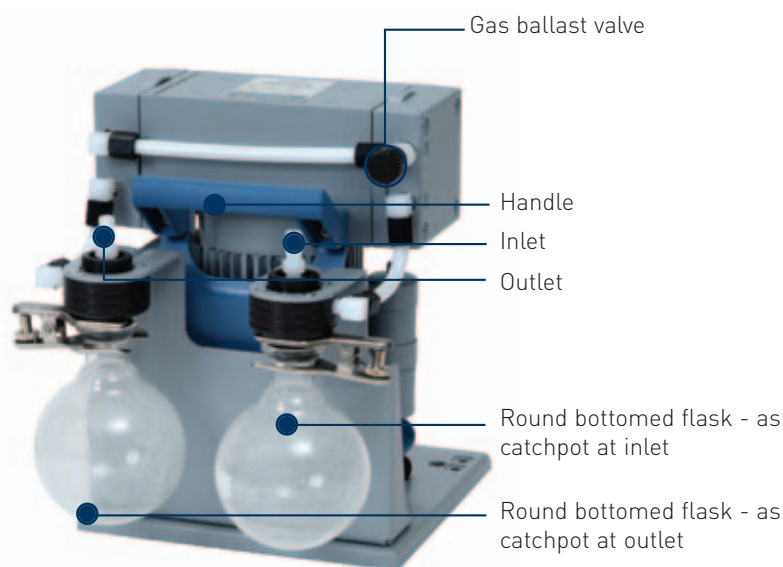

MZ 2C + 2 AK

The chemistry vacuum system MZ 2C + 2 AK is equipped with an inlet and outlet separator. The inlet separator prevents droplets and particles from entering the pump. The outlet separator allows a controlled collection of condensed solvent vapours and prevents condensate in the exhaust line from draining back into the pump.

ORDERING INFORMATION

Complete System

Chemistry diaphragm pump MZ 2C mounted on pump support. Separator at inlet and outlet. On/off switch, cable with plug and instructions for use.

Part No.

68 80 18

Replacement Parts & Accessories

Hose (rubber) NW 10mm

68 60 02

BENEFITS INCLUDE

- **Oil-free vacuum down to ~ 9mbar ultimate vacuum** - i.e. the lowest pressure that can be produced and measured reproducibly in a vacuum system at room temperature
- **Selected chemically resistant material**
- **Gas ballast valve as standard for working with condensable vapours**
- **High pumping speed sustained at nearly ultimate vacuum**
- **Solvent recovery close to 100%**
- **Long lifetime, easy-to-change diaphragms and valves**
- **Quiet, low noise**
- **Compact design**
- **Efficient and environmentally friendly**

TECHNICAL SPECIFICATION

	MZ 2C + 2 AK
Unit Dimensions (W x L x H)	24.1 x 34.5 x 32.6cm
Vacuum Pump	Chemistry Diaphragm Pump, MZ 2C
Number of Stages	2
Pumping Speed 50/60 Hz	1.9m ³ /h / 2.1 m ³ /h // 1.2cfm
Ultimate Vacuum (total)	9 mbar // 6.8 Torr
Ultimate Vacuum with Gas Ballast	15 mbar // 11 Torr
Inlet Connection (IN)	Hose nozzle NW 10mm
Outlet Connection (EX)	Hose nozzle NW 10mm
Weight	11.9kg
Pump Flow Rate	35L/min

For a 110VAC electrical system use code 68 80 18-A

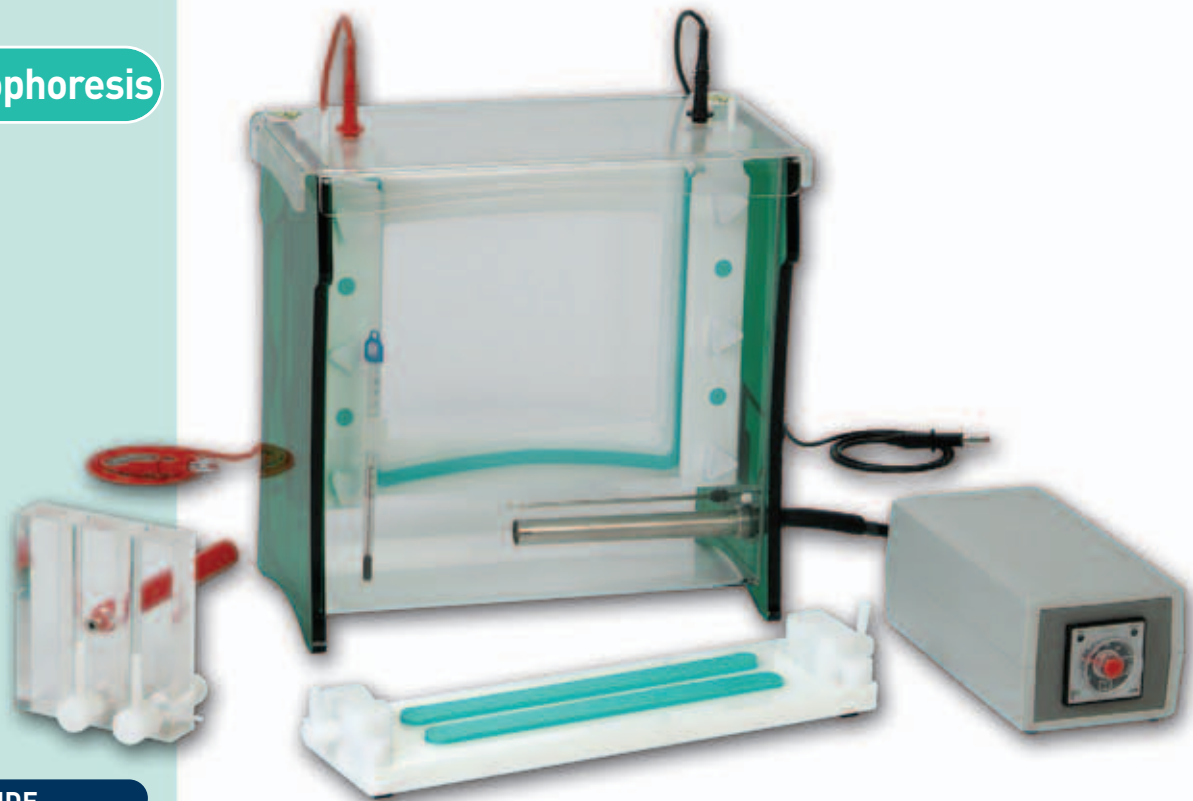

BENEFITS INCLUDE

- **Maximum 96-sample throughput** - using two 48-sample combs - allows samples to be transferred quickly and easily to the each gel from standard 96-well microplates or thermal cycler blocks
- **Large format** - 20.5 x 20cm glass plates allow gradient gels to be poured containing wider ranges of denaturant concentration, maximising sensitivity and resolution
- **100ml gradient mixer** - used with the new-style TV400-GRM and casting base to make two 1mm parallel denaturing gradient gels
- **Formamide, urea and acrylamide available** - to pour denaturing gradient gels - contact sales@scie-plas.co.uk
- **Can also be adapted for constant denaturing gel electrophoresis (CDGE)** - if the denaturant concentration required for partial melting of the DNA target sequence is already known



The TV400-DGGE Denaturing Gradient Gel Electrophoresis System

The TV400-DGGE denaturing gradient gel electrophoresis system is a cost-effective solution for researchers studying mutations and DNA polymorphisms critical in disease aetiology and genetic diversity. Designed primarily for parallel denaturing gradient gel electrophoresis (DGGE), where electrophoresis and the denaturing gradient run in the same direction, the TV400-DGGE has a maximum 96-sample throughput compatible with standard microplates and thermal cycler blocks. A 100ml gradient mixer is also included to pour gradient gels using our newly designed gel-running module and cam-caster, while a 400W heater, regulated by an external temperature control unit connected to a heat sensor within the gel tank, allows the gel temperature to be set to the predetermined melting temperature (T_m) of the PCR[®]-amplified DNA polymorphism or mutation of interest.

- **400W heating element** - manually controlled by a temperature control unit connected to a PT100 heat sensor - enables the gel and buffer temperature to be set in 1°C increments to a predetermined T_m , to a maximum 70°C

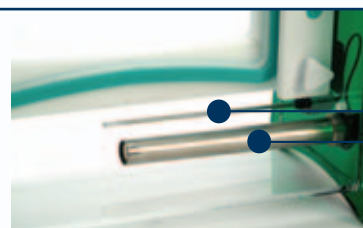

PT100
Heat
Sensor

400W
heating
element

TECHNICAL SPECIFICATION

TV400 GRM + Heated Tank		
Unit Dimensions (W x D x H)	28.5 x 15 x 29cm	
Inner Tank Dimensions (W x D x H)	27 x 12.5 x 26cm	
Plate Dimensions (W x H x T)	20.5 x 20 x 0.4cm	
Standard Spacer Dimensions (W x H x T)	2 x 20 x 0.1cm	
Active Gel Dimensions (W x H)	16.5 x 17.5cm	
Sample Capacity	2 x 24	
Recommended Buffer Volume	Inner Buffer Chamber	700ml
	Gel Tank	4200ml
Recommended Running Conditions for Denaturing/Native PAGE Gel	Voltage	175 - 225V (8.75 - 11.25V/cm)
	Current	20 - 30mA
	Time	2.5 - 3.5h
Temperature Range Thermometer	0 - 100 °C	
Power Output of Heating Element	400W	
Heating Element Dimensions (L x D)	14 x 1.5cm	
Operating Range of PT100 Temperature Sensor	-50 to +200 °C	
PT100 Temperature Sensor Dimensions (L x D)	14 x 0.3cm	
Casting Base Silicone Seal Dimensions (W x L x H)	1.7 x 22.5 x 0.8cm	
Power Output Connectors (diameter)	Shrouded, 4mm	
Recommended Power Supplies	Consort EV243	
HS-UNIT		
Unit Dimensions (W x D x H)	9.6 x 14 x 8cm	
Recommended Temperature Control Range	50 to 70 °C	
Temperature Control Accuracy	+/-1 °C	
GM100		
Unit Dimensions (W x D x H)	11 x 3 x 13.5cm	
Internal Dimensions of Mixing and Reservoir Chambers (Diameter x Height)	2.5 x 12.5cm	
Volume of Each Chamber	50ml	
Internal Diameter of Outlet Port	2mm	

HS-UNIT heat sensor control unit - manually adjustable in 1°C increments to the desired T_m



PARALLEL DGGE - OVERVIEW

Parallel DGGE is based on the application of a denaturant concentration gradient - increasing in the direction of electrophoresis within a polyacrylamide gel - and uniform temperature to induce the partial unwinding or melting of double-stranded DNA by distinct domains in a sequence-specific manner. Melting breaks the hydrogen bonds holding together each base pair within a DNA sequence: with domains rich in G-C base pairs melting at higher temperatures than those with high A-T base-pair content. Incorporating sequence high in G-C content into the DNA target sequence by PCR[®] amplification (GC-clamping) prevents the DNA target with the lowest melting domain from melting completely at its predetermined T_m , which is maintained by the application of a constant temperature across the gel and within the buffer. Because both gel temperature and increasing denaturant concentration act to melt DNA in a sequence- and domain-specific manner, any point mutations amplified within a PCR[®] product will affect its T_m so that its subsequent mobility within a polyacrylamide gel differs from its wild type counterpart (see schematic diagram). Consequently, the sensitivity of this technique in distinguishing individual DNA sequences, which might differ only by a single point mutation, has proven highly attractive to scientists screening for unknown mutations.

Schematic of Parallel DGGE

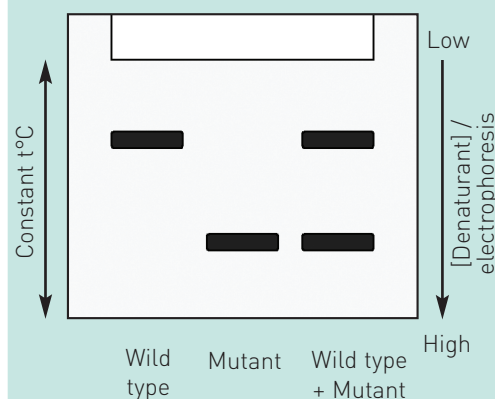

ORDERING INFORMATION

Complete System

Twin-plate maxi-gel unit with GRM, heated gel tank with PT100 temperature sensor and thermometer, lid, 2 x (20.5 x 20cm; W x H) plain glass plates, 2 x (20.5 x 20cm) notched glass plates, 4 x 1mm spacers, 2 x spacer aligners and 2 x 1mm thick 24-sample combs, casting base, 2 x silicone seals and 1 x dummy plate; plus GM100 gradient mixer and heat sensor control unit

Part No.

TV400-DGGE

as above for 110VAC

TV400-DGGE-A

Replacement Parts & Accessories

1 x TV400 gel-running module	TV400-GRM
2 x (20.5 x 20cm) plain glass plates for TV400	TV400-PG
2 x (20.5 x 20cm) notched glass plates for TV400	TV400-NG
1 x dummy plate	TV400-DP
2 x 1mm thick spacers for TV400	TV400-S1
2 x spacer aligners for TV400	TV400-SA
1 x cam-pin casting base with 2 silicone seals	TV400-CB
2 x silicone seals for cam-pin casting base	TV400-CB-SEALS
1 x 100ml gradient mixer	GM100
1 x caster system for 2 x (20.5 x 20cm) gradient maxi-gels	TV400-MC2
2 x 0.2mm thick, platinum electrode wire	PT-0.2
2 x 1 metre power leads with shrouded 4mm power output connectors	CABLE-4

Reagents & Chemicals

1 x Formamide, 100ml	21710.01
1 x Urea, 1kg	24524.02
1 x Acrylamide-Bis Solution, 37.5:1 (40% w/v), 2.6%C, 500ml	10681.01

TV400-DGGE Combs

Part No.	Thickness (mm)	Sample Throughput	Tooth Width (mm)	Tooth Height (mm)	Max. Spacing (mm)	Sample Volume / Well (µl)
TV400-C1-24 (standard)	1	24	4.75	20	2	95
TV400-C1-48 (optional)	1	48	2.35	20	1	47

DO YOU NEED...?

A GRADIENT MIXER	SEE PAGE 79
ACRYLAMIDE	SEE PAGE 118
A GEL MULTICASTER	SEE PAGE 80
A POWER SUPPLY	SEE PAGES 91-92
A GEL DOCUMENTATION SYSTEM	SEE PAGE 96



Gradient Mixers

Available in 15, 25, 50, 100 and 500ml volumes, Scie-Plas's gradient mixers are ideal for pouring polyacrylamide gradient gels and centrifugation gradients using sucrose or caesium chloride solutions. Each gradient mixer is precision engineered from high quality acrylic plastic and comprises leak-free valves that control mixing between the reservoir and mixing chambers and the resultant output flow.

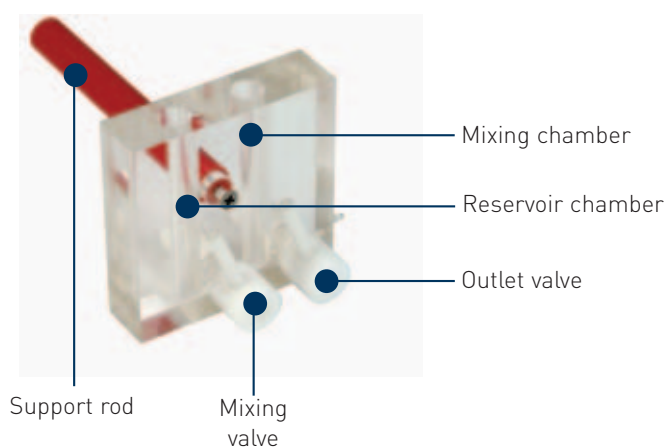

TECHNICAL SPECIFICATION

	GM15	GM25	GM50	GM100	GM500
Unit Dimensions (W x D x H)	9 x 2.4 x 9cm	10 x 2.4 x 11.5cm	10 x 2.4 x 11.5cm	11 x 3 x 13.5cm	13 x 6 x 14cm
Internal Dimensions of Mixing and Reservoir Chambers (Diameter x Height)	1.3 x 8cm	1.4 x 10cm	1.9 x 10cm	2.5 x 12.5cm	5.4 x 13cm
Volume of Each Chamber	7.5ml	12.5ml	25ml	50ml	250ml
Internal Diameter of Outlet Port	2mm	2mm	2mm	2mm	5mm

ORDERING INFORMATION

Complete System

1 x 15ml gradient mixer
 1 x 25ml gradient mixer
 1 x 50ml gradient mixer
 1 x 100ml gradient mixer
 1 x 500ml gradient mixer

Part No.

GM15
 GM25
 GM50
 GM100
 GM500

BENEFITS INCLUDE

- Available in 5 different sizes - for different applications
 - **GM15 and GM25** - 15 and 25ml volumes for sucrose and caesium chloride gradients; the GM25 can also make two 1mm thick, 10 x 10cm gradient gels in the TV100-MC2 2-gel multicaster
 - **GM50** - 50ml volume sufficient to pour up to five 1mm thick, 10 x 10cm gradient gels or one standard 1mm thick, 20.5 x 20cm gel using the TV400 casting base
 - **GM100** - 100ml volume for pouring up to ten 1mm thick, 10 x 10cm gels in the TV100-MC10 10-gel multicaster or two 1mm thick, 20.5 x 20cm gels using the TV400-MC2 2-gel multicaster
 - **GM500** - 500ml volume suitable for up to ten 1mm thick, 20.5 x 20cm gels
- **Reservoir chamber** - designed to contain higher percentage acrylamide solution when making gradient gels with the TV100 and TV400 multicasters
- **Mixing chamber** - each is of sufficient diameter to accommodate a magnetic stirrer to mix lower percentage acrylamide with higher percentage acrylamide from the reservoir chamber
- **Valves** - control output flow from both the reservoir and mixing chambers
- **Flat base** - allows each gradient mixer to be placed onto a magnetic stirring plate
- **Support rod** - secures each gradient mixer to a retort stand
- **Can be used in conjunction with the Buffer Recirculation Pump** - see page 35

BENEFITS INCLUDE

- **Available in 4 different formats:** -
 - **TV100-MC2** - casts two 1mm thick, 10 x 10cm standard or gradient mini-gels
 - **TV100-MC10** - casts up to ten 1mm thick, 10 x 10cm standard or gradient mini-gels
 - **TV200-MC2** - casts two 1mm thick, 20.5 x 10cm standard or gradient wide format mini-gels
 - **TV400-MC2** - casts two 1mm thick, 20.5 x 20cm standard or gradient maxi-gels
- **Dovetailed silicone gasket** - acts in conjunction with 5 nylon screws to distribute pressure evenly across the glass plates for leak-free casting
- **Separation sheets** - 1mm thick - for easy separation of each gel cassette after casting and to maintain the correct pressure between the glass plates and the front plate of the casting chamber, ensuring that straight gels, of uniform thickness, are poured
- **V-shaped cavity** - stabilises the gradient in the bottom of casting chamber
- **Inlet ports** - maintain the steady flow of acrylamide into the casting unit before polymerisation

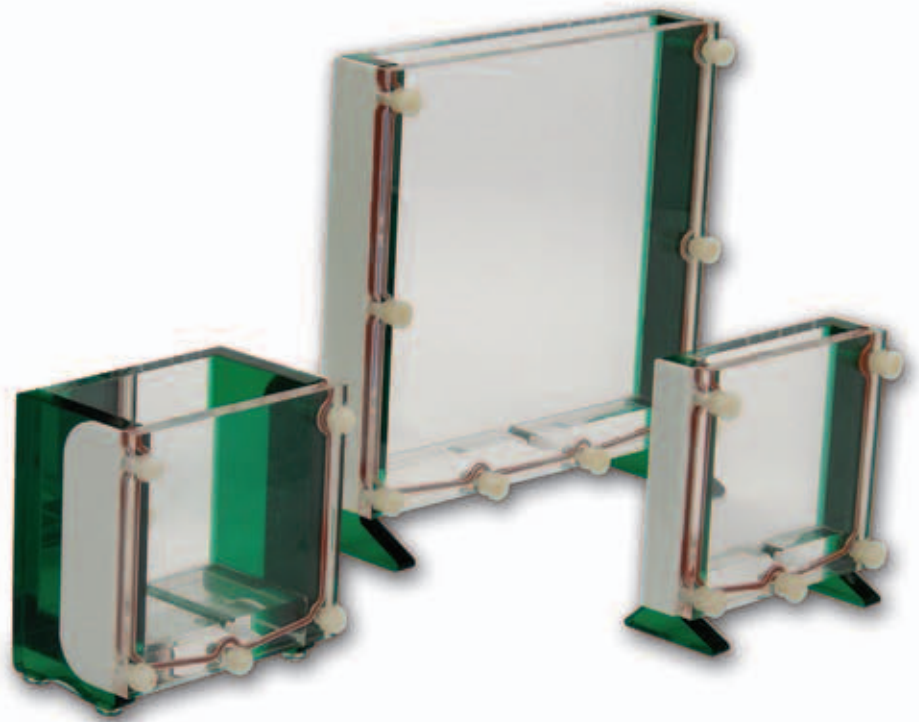

TV100, TV200 and TV400 Gel Multicasters

Scie-Plas now offers 2 and 10 gel multicasters for use with its 10 x 10cm (W x H) TV100 mini-gel, 20.5 x 10cm TV200 wide format mini-gel and 20.5 x 20cm TV400 maxi-gel units. Gels can be poured either as gradient gels with the hose connected to the inlet port at the bottom of the front plate, or as standard polyacrylamide gels from the top of the casting chamber using a pipette.

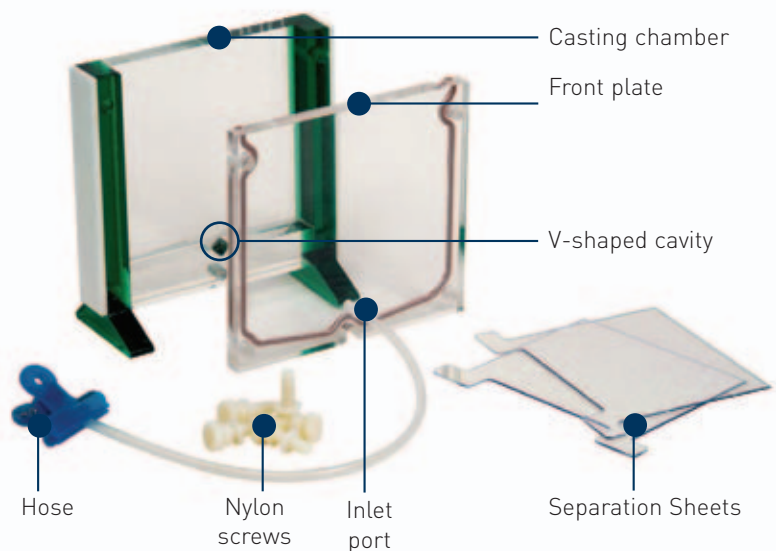

TECHNICAL SPECIFICATION

	TV100-MC2	TV100-MC10	TV200-MC2	TV400-MC2
Unit Dimensions (W x D x H)	13 x 3.2 x 13.5cm	13 x 8 x 13.5cm	23.5 x 4 x 11.5cm	23.5 x 4 x 21.5cm
Casting Chamber Dimensions (W x D x H)	10 x 1.2 x 10cm	10 x 6 x 10cm	20.5 x 2 x 10cm	20.5 x 2 x 20cm
Internal Diameter of Outlet Port	2mm	2mm	2mm	2mm
Compatible gradient mixer	GM25/GM50	GM100	GM50/100	GM100

ORDERING INFORMATION

Complete System

1 x 2-gel multicaster for 10 x 10cm mini-gels includes 10 x 1mm separation sheets, 2 x 0.4mm spacer aligners and 3mm internal diameter nylon hose

Part No.

TV100-MC2

1 x 10-gel multicaster for 10 x 10cm mini-gels includes 20 x 1mm separation sheets, 2 x 0.4mm spacer aligners and 3mm internal diameter nylon hose

TV100-MC10

Replacement Parts & Accessories

10 x 1mm separation sheets for TV100-MC2 and TV100-MC10

TV100-SS

2 x spacer aligners for TV100

TV100-SA

Complete System

1 x 2-gel multicaster for 20.5 x 10cm wide format mini-gels includes 10 x 1mm separation sheets, 2 x 0.4mm spacer aligners and 3mm internal diameter nylon hose

Part No.

TV200-MC2

Replacement Parts & Accessories

10 x 1mm separation sheets for TV200-MC2

TV200-SS

2 x spacer aligners for TV200

TV200-SA

Complete System

1 x 2-gel multicaster for 20.5 x 20cm maxi-gels includes 10 x 1mm separation sheets, 2 x 0.4mm spacer aligners and 3mm internal diameter nylon hose

Part No.

TV400-MC2

Replacement Parts & Accessories

10 x 1mm separation sheets for TV400-MC2

TV400-SS

2 x spacer aligners for TV400

TV400-SA

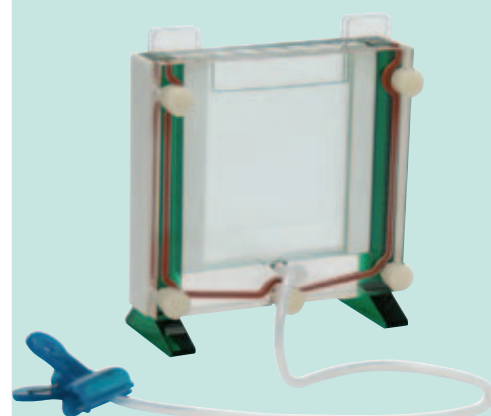

For glass plates and spacers compatible with the...

- TV100-MC2 and TV100-MC10 - see page 51
- TV200-MC2 see page 55
- TV400-MC2 see page 58

Gel Temperature Control

BENEFITS INCLUDE

- **Ergonomic design and easy operation**
- **Splash-proof keypad** with integrated mains switch
- **Large, bright LED**
- **Reliable microprocessor PID temperature control**
- **Filling level indicator**
- **Powerful immersion pumps** - suitable for continuous operation
- **Maximum permissible temperature of +80°C** - in the return line from the unit to the chiller
- **Easy access to filling chamber** - via a hinged lid at the top of the unit
- **Low liquid level protection with visible and audible alarm signal**
- **Integrated stainless steel bath tanks**
- **Removable venting grid for cleaning of the condenser**
- **Front drain**
- **No side vents** - allow multiple units to be stacked alongside each other
- **RS232 interface for PC connection**
- **IP class according to IEC 529: IP21**

TECHNICAL SPECIFICATION

Working Temperature Range	-20 to +40°C
Temperature Control	PID
Temperature Stability	±0.5°C
Display	LED
Display Resolution	0.1°C
Integrated Programmer	Not available
Heater Capacity	0W
Cooling Capacity	20 10 0 -5 -20 °C 300 250 200 150 100 W
Refrigerant	R134a
Pump Capacity	Pressure: 350mbar Flow rate: 15L/min
Digital Interfaces	RS232
Filling Volume	3 to 4.5L
Suitable Fluids	Water, water-glycerol & JULABO thermal bath fluids
Fittings	Barbed fittings for tubing of 8 and 12mm internal diameter
Pump Connections	M16x1 male
Dimensions (W x L x H)	25 x 50 x 60cm
Weight	41kg
Ambient Temperature	5 to 40°C
Classification according to DIN 12876-1	-
Available mains power	230V/50Hz; 115V/60Hz; 230V/60Hz

Recirculating Cooler/Chiller

The recommended recirculating cooler/chiller option for all Scie-Plas horizontal and vertical cooled gel electrophoresis units. Unlike other chiller units, which are factory preset at 4°C, the working temperature of the FL300 can be set anywhere between -20 and +40°C, making it ideally suited to many techniques ranging from standard cooled gel electrophoresis to IEF with IPG strips. PID (Proportional Band, Integral, Derivative) control guarantees thermal stability within ±0.5°C of the set temperature, obviating the need for continuous



operator monitoring. Each unit can be easily cleaned and is supplied with a splash-proof keypad with a bright, easy-to-read LED that indicates the current temperature, while an RS232 interface is located at the front of each unit for PC connection and alarm shutdown. A lift-up cover on the top of the unit allows access to the filling port, while another hinged tray serves as storage for the operating manual and installation documents. A removable venting grid provides ready access to the condenser and drainage tap for cleaning. All models include an easily visible level indicator for the coolant, whereas vents positioned at the front and rear allow multiple units to be placed side by side, saving space within the laboratory.

ORDERING INFORMATION

Complete System

FL300 recirculating cooler/chiller unit for 230 Vac
mains power supply
(please specify if 230V/50Hz or 230V/60Hz is required)
FL300 recirculating cooler/chiller unit for 110 Vac
mains power supply

Part No.

FL300

FL300-A

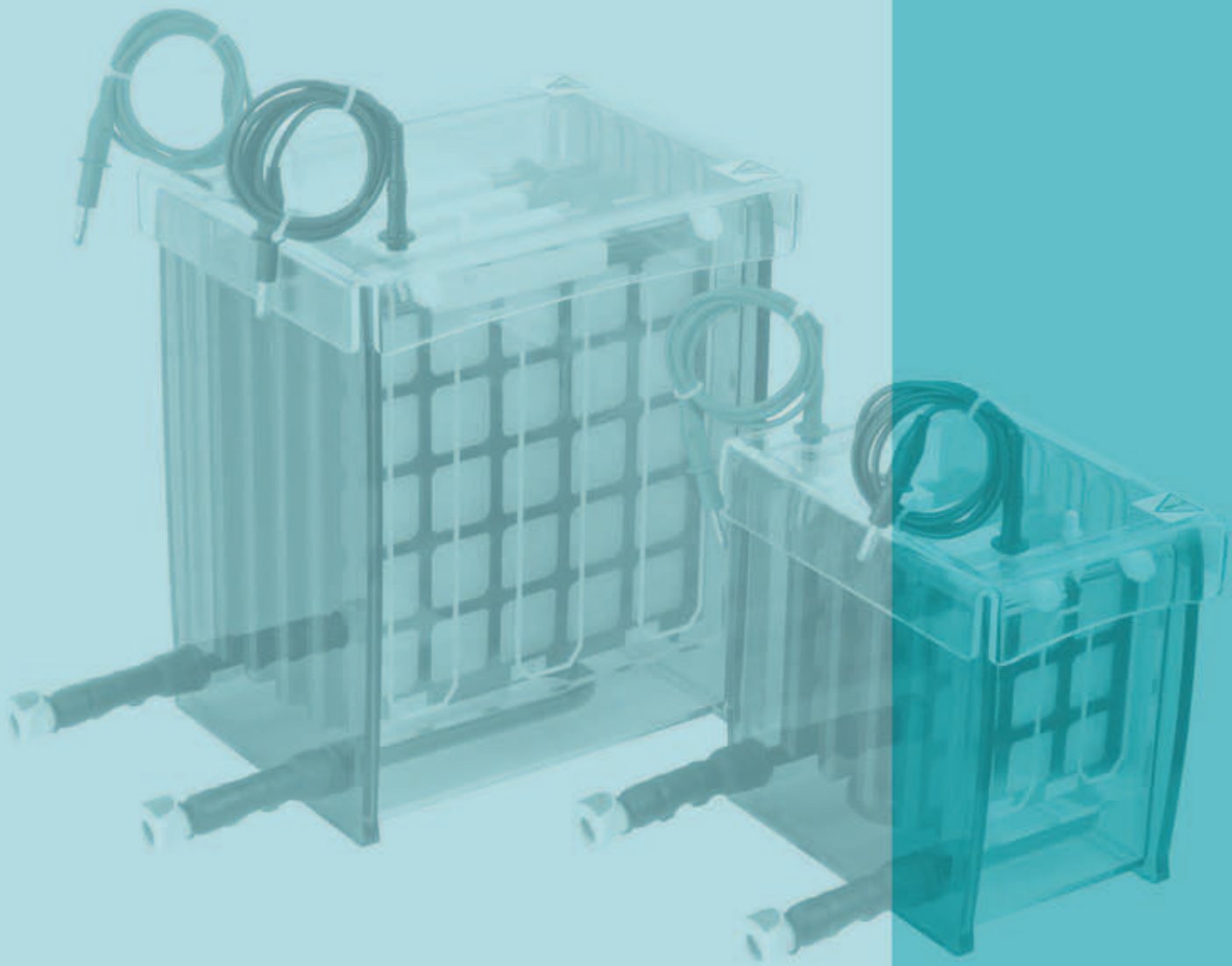

Blotting Units

Blotting Units

BENEFITS INCLUDE

- **Available in 2 different formats:** -
 - **TV100-EBK** - accommodates a maximum of four 10 x 10cm electroblotting cassettes
 - **TV400-EBK** - accommodates a maximum of four 20.5 x 20cm electroblotting cassettes
- **Asymmetric, colour-coded cassettes** - hinged, with red and black covers corresponding to the anode and the cathode, to ensure correct transfer
- **Fibre pads** - compress the gel against the nitrocellulose membrane for uniform transfer
- **Plate-electrodes** - 12.8cm apart - maximise the intensity of the electric field, allowing rapid transfer within 4 to 6 hours
- **Enhanced cooling** - included as standard - snap-lock connectors allow the cooling coil within each unit to be connected to an external chiller units for faster, high-intensity transfers, or extended overnight runs without buffer depletion
- **Flat bottom** - allows each electroblotter to be placed directly onto a magnetic stirring plate
- **Blotting paper, membranes and chemicals also available see pages 117-124**

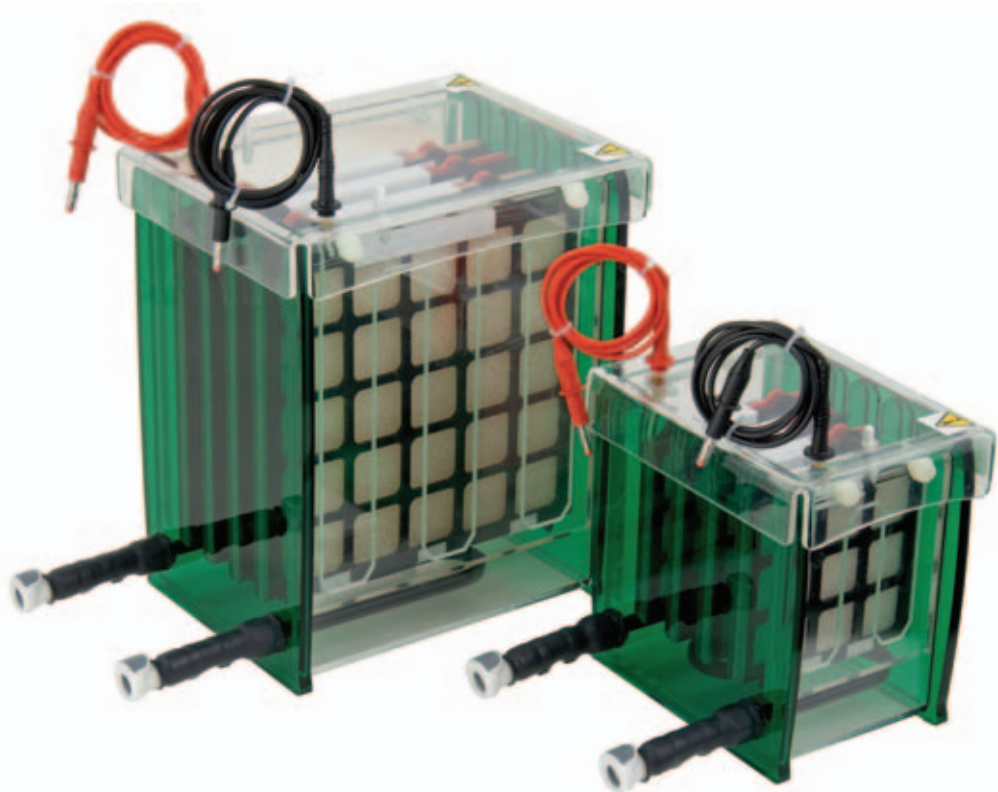

The TV100-EBK Mini and TV400-EBK Maxi Electroblotters

Recently redesigned to accommodate up to 4 electroblotting cassettes, the Scie-Plas TV100-EBK and TV400-EBK electroblotters provide a cost-effective and safe and easy to use system for the transfer of proteins and nucleic acids from 10 x 10cm mini and 20.5 x 20cm maxi gels. Both units are supplied with asymmetric colour-coded cassettes as a unique design feature to prevent them from being inserted into the tank in the wrong orientation, against the direction of transfer.

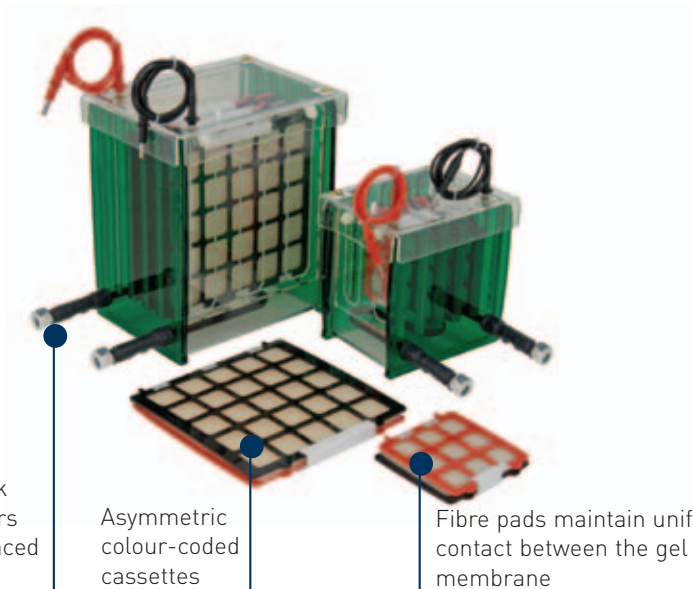

ELECTROBLOTTING CASSETTE ASSEMBLY

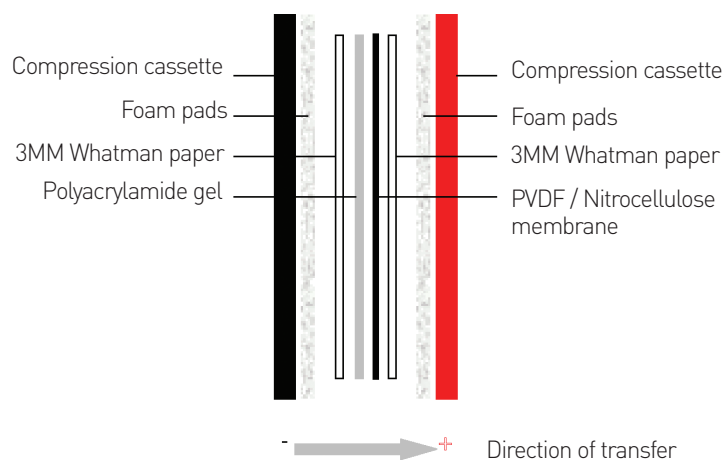

TECHNICAL SPECIFICATION

	TV100-EBK	TV400-EBK
Unit Dimensions (W x D x H)	20 x 22.5 x 18.5cm	19.5 x 32.5 x 28.5cm
Inner Tank Dimensions (W x D x H)	12.8 x 11 x 17cm	12.8 x 21 x 26cm
Maximum Sample Capacity	4 cassettes	4 cassettes
Recommended Buffer Volume	2000ml	6300ml
Recommended Running Conditions for Electroblotting	Voltage	50 - 100V
	Current	75mA [0.6-0.8mA/cm ²]
	Time	2-4h
Distance Between Plate Electrodes in EBGRM		12.8cm
		12.8cm
Electroblotting Cassette Dimensions (W x L)	11.5 x 10.5cm	20.5 x 20cm
Active Transfer Area	71cm ²	289cm ²
Snap-lock Connectors for Cooling Coil	Inner Diameter	10mm
	Outer Diameter	12mm
Quick-fit Tubing	Inner Diameter	10mm
	Outer Diameter	12mm
Power Output Connectors (diameter)	Shrouded, 4mm	Shrouded, 4mm
Recommended Power Supply	Consort EV243	Consort EV243

ORDERING INFORMATION

Complete System

Complete electroblotting system for four 10 x 10cm mini-gels, including 4 x electroblotting cassettes, 4 x fibre pads, cooled tank, lid and quick-fit tubing

Part No.

TV100-EBK

Complete electroblotting system for four 20.5 x 20cm maxi-gels, including 4 x electroblotting cassettes, 4 x fibre pads, cooled tank, lid and quick-fit tubing

TV400-EBK

Replacement Parts & Accessories

1 x (10 x 10cm) hinged, colour-coded cassette with fibre pads	TV100-EBC
4 x (10 x 10cm) fibre pads	EB-FPS
1 x (20.5 x 20cm) hinged, colour-coded cassette with fibre pads	TV400-EBC
4 x (20.5 x 20cm) fibre pads	EB-FPL
2 x quick-fit tubes for cooling coil	TCS-CC
2 x 0.2mm thick, platinum electrode wire	PT-0.2100CM
2 x 1 metre power leads with shrouded 4mm power output connectors	CABLE-4



DO YOU NEED...?

BLOTTING PAPER & MEMBRANES	SEE PAGE 124
TRANSFER BUFFER	SEE PAGE 124
A RECIRCULATING CHILLER	SEE PAGE 82
A POWER SUPPLY	SEE PAGES 91-92

BENEFITS INCLUDE

- **2 sizes available:** -
 - **V10-SDB** – 10 x 10cm format - accommodates one 10 x 10cm mini-gel
 - **V20-SDB** – 20 x 20cm format - accommodates up to four 10 x 10cm mini-gels or one 20 x 20cm maxi-gel
- **Gels can be stacked** – for higher throughput blotting
- **Rapid transfer assured within 1 hour** – for lower molecular weight proteins and nucleic acids; larger molecules transferred in 2 hours
- **Semi-dry format** – minimises buffer consumption, with no need for mess and additional accessories
- **Colour-coded, corrosion-free plate electrodes** – platinum-coated titanium anode and stainless steel cathode maximise the transfer area, so that full electrical contact is made between the gel and the membrane, while corrosion-resistant metal prolongs lifespan and durability
- **Blotting paper, membranes and chemicals also available** – see page 124

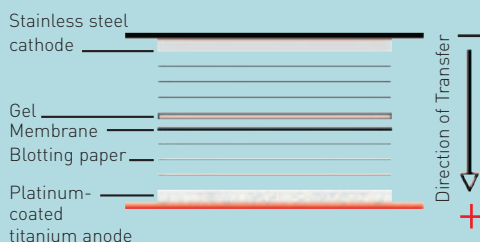

Semi-dry blotting with Scie-Plas V10-SDB and V20-SDB units

Three sheets of blotting paper, saturated with transfer buffer, are first superimposed over the anode plate, followed by the membrane, the gel and a further 3 sheets of blotting paper. The cathode plate is then placed over the blotting sandwich and the current applied at 0.8mAcm^{-2} for 1 to 2 hours.



The V10-SDB and V20-SDB Semi-Dry Blotters

The V10-SDB 10 x 10cm and V20-SDB 20 x 20cm semi-dry blotters are ideal for fast transfer of proteins and nucleic acids without the need for costly accessories such as gel cassettes and tanks. Corrosion-free platinum-coated titanium and stainless steel plate electrodes, corresponding to the anode and cathode, maximise the active area of transfer so that full electrical contact is made between the gel and the membrane, allowing transfer to be completed within an hour with the minimum of heat dissipation, buffer consumption and mess in the laboratory, normally associated with wet blotting techniques.

TECHNICAL SPECIFICATION

	V10-SDB	V20-SDB
Unit Dimensions (W x D x H)	17 x 7.5 x 17cm	27 x 7.5 x 27cm
Active Transfer Area (W x L)	10 x 10cm	20 x 20cm
Sample Throughput	One 10 x 10cm mini-gel	Four 10 x 10cm mini-gels; One 20 x 20cm maxi-gel
Recommended Current Setting	80mA / 0.8mAcm^{-2}	320mA / 0.8mAcm^{-2}
Power Output Connectors (diameter)	4mm	4mm
Recommended Power Supplies	EV243	EV265, 261 & 215

ORDERING INFORMATION

Complete System

10 x 10cm semi-dry blotter
20 x 20cm semi-dry blotter

Part No.

V10-SDB
V20-SDB



The CP-2826 Maxi Capillary Blotter

The CP-2826 maxi capillary blotter is ideal for the simultaneous Northern and Southern transfer of multiple gels. A novel design feature of a permanent wick set within the lower tank is optimised to draw up more buffer than traditional systems, eliminating the need for messy overhanging paper wicks and maximising transfer efficiency to less than 3 hours for nucleic acids

Floating lid maintains even pressure across the gel without the need to apply extra weight.

The gel-membrane sandwich is overlaid with additional materials in the following order:

1. blotting paper,
2. absorbent towel
- and 3. cardboard.

The porous polyethylene wick serves as a gel support, which draws transfer buffer from the lower chamber by capillary action.

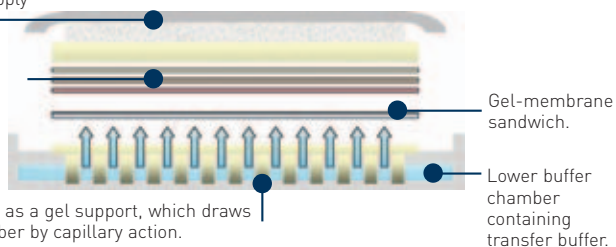

Gel-membrane sandwich.

Lower buffer chamber containing transfer buffer.

Schematic Diagram of the Maxi Capillary Blotter

Once impregnated with buffer the porous polyethylene wick draws buffer through the gel by capillary action, evenly transferring nucleic acids onto the membrane regardless of their molecular weight. Any surrounding area of the wick not involved in transfer is masked with cellophane wrapping to prevent uneven transfer.

TECHNICAL SPECIFICATION

	CP-2826
Unit Dimensions (W x D x H)	41.5 x 29 x 10.5cm
Inner Tank Dimensions (W x D x H)	38.5 x 27 x 5cm
Active Transfer Area	728cm ²
Recommended Buffer Volume	500ml
Transfer Time for DNA/RNA from a 6mm, 0.8 to 1.2% Agarose Gel	2h

ORDERING INFORMATION

Complete System

Capillary blotting unit (28 x 26cm; W x L)

Part No.

CP-2826

BENEFITS INCLUDE

- **CP-2826** – 28 x 26cm wick - for simultaneous transfer of seven 10 x 10cm gels
- **Permanent wick** – serves as porous support for the gel, eliminating the problems associated with uneven transfer by allowing buffer to be drawn more efficiently from the lower tank, thus effecting nucleic acid transfer in <3 hours
- **Simple design** – guarantees fast and easy set up
- **Floating lid** – compresses the gel against the membrane for uniform transfer without the need to apply a weight, causing mechanical damage to the gel
- **Blotting paper, membranes and chemicals also available see pages 117-124**

Blotting Units

BENEFITS INCLUDE

- **Rapid transfer assured within minutes**
 - dot/slot microfiltration manifold allows unfractionated samples to be immobilised onto a membrane for immediate screening with nucleic acid probes or antibodies
- **Available in 3 different formats:**
 - **DHM-48** - for 5 x 12.8cm membranes - 48-sample throughput
 - **DHM-96** - for 7.5 x 11.3cm membranes - 96-sample throughput
 - **SHM-48** - for 5 x 12.8cm membranes - 48-sample throughput
- **Compatibility (DHM Only)** - with multi-channel pipettes and standard 96-well microtitre plates ensures fast loading of the manifold
- **Simple design** - based on the alignment of stainless steel thumbscrews and mating screws - guarantees fast and easy set up without the need for gaskets and 'O' rings
- **Dot/slot blot imaging and quantitation** - available on the Vision gel documentation system
- **Blotting paper, membranes and chemicals also available see pages 117-124**

DO YOU NEED...?

BLOTTING PAPER & MEMBRANES	SEE PAGE 124
A VACUUM PUMP	SEE PAGE 75
A THERMAL CYCLER	SEE PAGE 99
A UV STERILISATION CABINET	SEE PAGE 98



Dot and Slot Blot Microfiltration Manifolds

Available in alphanumeric 48 and 96 sample throughputs, Scie-Plas's dot and slot blot microfiltration manifolds provide an easy and reproducible means to hybridise proteins and nucleic acids in solution onto membranes. These manifolds, which are machined from high-density acrylic, have precision-lapped mating surfaces that ensure uniform filter/membrane contact without gaskets and 'O' rings. Manifold assembly is simple, being achieved by the alignment and tightening of stainless steel thumbscrews and mating screws, while filters can be cut down to the exact size of the template. Standard manifold configurations are available with the DHM-48 and -96 units providing 48 and 96 dots, 3mm in diameter, that are compatible with the configuration of 96-well microtitre plates. The SHM-48 units focus up to 48 samples into thin lines, less than 0.5 x 6mm in size, making densitometric quantitation more reproducible. Each hybridisation manifold requires a vacuum pump or water aspirator equivalent to 600mm Hg (0.8 Bar).

Upper manifold - allows sample to be loaded into each dot/slot

Template - allows membranes to be cut down to size

Vacuum Port - can be connected to a water aspirator or vacuum pump

Vacuum reservoir - serves as a collection chamber for filtrate

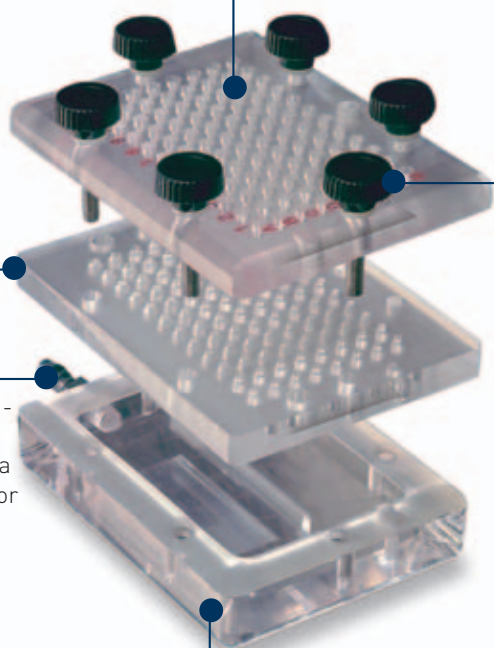

Stainless steel thumbscrews and precision-lapped mating surfaces - maintain vacuum transfer without sample smearing, cross contamination and leakage

TECHNICAL SPECIFICATION

	SHM-48	DHM-48	DHM-96
Unit Dimensions (W x D x H)	18.5 x 7.5 x 7cm	18.5 x 7.5 x 7cm	17 x 10.5 x 7cm
Maximum Sample Capacity	48	48	96
Dot Diameter	-	3mm	3mm
Slot Dimensions (W x L)	3 x 12mm	-	-
Sample Volume / Dot	-	100µl	100µl
Sample Volume / Slot	300µl	-	-
Minimum Membrane Size (W x L)	5 x 12.8cm	5 x 12.8cm	7.5 x 11.3cm
Vacuum Port External Diameter	7mm	7mm	7mm
Vacuum Port Internal Diameter	6mm	6mm	6mm
Maximum Operating Temperature	65°C	65°C	65°C
Working Pressure of Pump or Water Aspirator	600mm Hg (0.8 Bar)	600mm Hg (0.8 Bar)	600mm Hg (0.8 Bar)

ORDERING INFORMATION

Complete System

	Part No.
48-well Dot Blot Hybridisation Manifold in 3 x 16 array, comprising paired upper dot-forming modules for dots 3mm in diameter, and lower vacuum chamber module.	DHM-48
96-well Dot Blot Hybridisation Manifold in 8 x 12 array, comprising paired upper dot-forming modules for dots 3mm in diameter, and lower vacuum chamber module.	DHM-96
48-well Slot Blot Hybridisation Manifold in 3 x 16 array, comprising paired upper slot-forming module for slots 0.5 x 6mm in size, and lower vacuum chamber module.	SHM-48

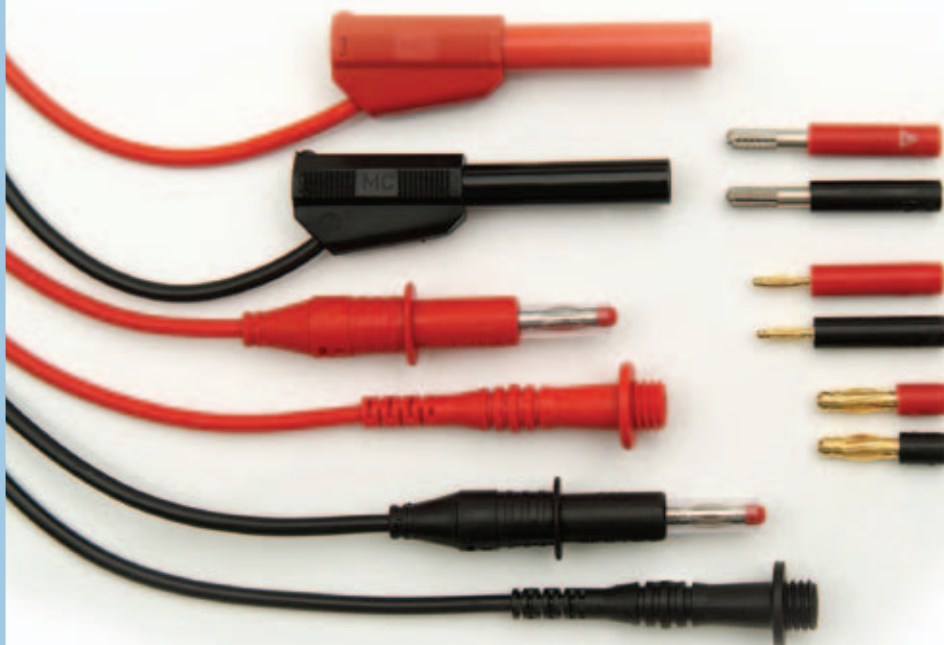

Power Supply Accessories

- **CABLE-4** - power output connectors, 4mm in diameter, designed for low-to-medium voltage power supplies. Supplied with all Scie-Plas horizontal and vertical gel electrophoresis units except the IEF-SYS.
- **CABLE-2** - power output connectors, 2mm in diameter, designed for high voltage power supplies. Only supplied with the IEF-SYS and TVS1400 units.

Although the power cables supplied with all standard Scie-Plas horizontal and vertical gel electrophoresis units have 4mm output connectors that are compatible with most modern low-to-medium voltage power supplies, problems with compatibility do arise occasionally when the power supply in the laboratory is from a different manufacturer. Scie-Plas has three solutions available to address this: -

- **4/4MMA adaptors** - allow standard Scie-Plas horizontal and vertical gel electrophoresis units to be connected to competitor low-to-medium voltage power supplies with deeply recessed power output terminals (i.e. banana jacks), 4mm in diameter
- **4/2MMA adaptors** - allow standard Scie-Plas horizontal and vertical gel electrophoresis units to be connected to high voltage power supplies and those with deeply recessed power output terminals (i.e. banana jacks), 2mm in diameter
- **2/4MMA adaptors** - allow the 2mm output connectors on Scie-Plas's specialised high-voltage electrophoresis units, such as the IEF-SYS and TVS1400, to be connected to low voltage powers supplies with 4mm outputs for low voltage applications

ORDERING INFORMATION

Accessory	Part No.
2 x 4mm-to-4mm adaptors for power supplies with 4mm output terminals	4/4MMA
2 x 4mm-to-2mm adaptors for power supplies with 2mm output terminals	4/2MMA
2 x 2mm-to-4mm adaptors for power supplies with 4mm output terminals	2/4MMA
2 x 1 metre power leads with 2mm output connectors	CABLE-2
2 x 1 metre power leads with 4mm output connectors	CABLE-4

Consort EV200 Range Power Supply Units

The Consort EV200 power supplies cover the range of voltages and currents used with all Scie-Plas electrophoresis units, whether it is for routine low voltage horizontal and vertical gel electrophoresis or high voltage applications such as isoelectric focusing and sequencing.



The voltage and current can be adjusted at any time during a run, and are displayed on the unit in bright, easy-to-read digits. Nine different program settings, each with 9 different parameters, allow more complex, multi-step techniques to be programmed and stored. All Consort EV200 power supplies include voltage ramping, automatic crossover and recovery after power failure as standard, in addition to full protection against overload and accidental short circuit.

Also introducing... The NEW Consort EV222 Power Supply

An ideal low cost power supply for routine horizontal and vertical gel electrophoresis which includes many features of the Consort EV200 units: manual programming, timer, automatic crossover, recovery after power failure and a 3-year warranty.



ORDERING INFORMATION

Power Supply

	Part No.
200 Volt, 200 Milliamp, 20 Watt power supply for 230Vac mains supply	EV222
300 Volt, 1000 Milliamp, 150 Watt power supply for 230Vac mains supply	EV231
300 Volt, 2000 Milliamp, 300 Watt power supply for 230Vac mains supply	EV202
400 Volt, 300 Milliamp, 50 Watt power supply for 230Vac mains supply	EV243
600 Volt, 500 Milliamp, 150 Watt power supply for 230Vac mains supply	EV265
600 Volt, 1000 Milliamp, 300 Watt power supply for 230Vac mains supply	EV261
1200 Volt, 500 Milliamp, 300 Watt power supply for 230Vac mains supply	EV215
3000 Volt, 150 Milliamp, 150 Watt power supply for 230Vac mains supply	EV232
3000 Volt, 300 Milliamp, 300 Watt power supply for 230Vac mains supply	EV233
6000 Volt, 150 Milliamp, 300 Watt power supply for 230Vac mains supply	EV262

For 110VAC electricity systems add -A to the end of these codes

BENEFITS INCLUDE

- Compact, portable and safe
- Manual and method programming
- Constant voltage, current or power settings
- Automatic crossover
- Overload protection
- Short circuit protection
- Three-year warranty

TECHNICAL SPECIFICATION

	EV222
Voltage	0...200V
Current	0...200mA
Power	0...20W
Parameter Range	1...100% of full scale
Timer	0...99:59h
Volt-hours	n/a
Display	LCD, 2x16 characters
Resolution	1V, 1mA, 1W
Programs	1 set of parameters
Outputs	3 in parallel, 4mm sockets
Minimum load resistance	15Ω
Buffer depletion detection	n/a
No load detection	on/off, programmable
Ground leakage detection	✓
Overload detection	✓
Computer control	n/a
Data/Logging	n/a
RS232	n/a
Ambient Temperature	0...40°C
Relative Humidity	0...95%, non condensing
Power Requirements	210...250VAC, 50/60Hz, 35W
Dimensions (WxDxH)	24x20x13cm
Weight	2kg

TECHNICAL SPECIFICATION

	EV243	EV231	EV265
VOLTAGE	0...400V	0...300V	0...600V
CURRENT	0...300mA	0...1000mA	0...500mA
POWER	0...50W	0...150W	0...150W
PARAMETER RANGE	1...100% of full scale	1...100% of full scale	1...100% of full scale
TIMER	0...99:59h	0...99:59h	0...99:59h
VOLT-HOURS	0...99.99kVh	0...99.99kVh	0...99.99kVh
DISPLAY	LCD, 2x16 characters	LCD, 2x16 characters	LCD, 2x16 characters
RESOLUTION	1V, 1mA, 1W	1V, 1mA, 1W	1V, 1mA, 1W
PROGRAMS	9x9 set of parameters	9x9 set of parameters	9x9 set of parameters
OUTPUTS	3 in parallel, 4mm sockets	4 in parallel, 4mm sockets	4 in parallel, 4mm sockets
MINIMUM LOAD RESISTANCE	30Ω	10Ω	30Ω
BUFFER DEPLETION DETECTION	on/off, programmable	on/off, programmable	on/off, programmable
NO LOAD DETECTION	on/off, programmable	on/off, programmable	on/off, programmable
GROUND LEAKAGE DETECTION	✓	✓	✓
OVERLOAD DETECTION	✓	✓	✓
COMPUTER CONTROL	✓	✓	✓
DATA/LOGGING	3600 values	3600 values	3600 values
RS232	9600b/s	9600b/s	9600b/s
AMBIENT TEMPERATURE	0...40°C	0...40°C	0...40°C
RELATIVE HUMIDITY	0...95%, non condensing	0...95%, non condensing	0...95%, non condensing
POWER REQUIREMENTS	210...250VAC, 50/60Hz, 75W	210...250VAC, 50/60Hz, 200W	210...250VAC, 50/60Hz, 200W
DIMENSIONS (WxDxH)	24x20x13cm	31x26x15cm	31x26x15cm
WEIGHT	3kg	6kg	6kg
	EV202	EV261	EV215
VOLTAGE	0...300V	0...600V	0...1200V
CURRENT	0...2000mA	0...1000mA	0...500mA
POWER	0...300W	0...300W	0...300W
PARAMETER RANGE	1...100% of full scale	1...100% of full scale	1...100% of full scale
TIMER	0...99:59h	0...99:59h	0...99:59h
VOLT-HOURS	0...99.99kVh	0...99.99kVh	0...99.99kVh
DISPLAY	LCD, 2x16 characters	LCD, 2x16 characters	LCD, 2x16 characters
RESOLUTION	1V, 1mA, 1W	1V, 1mA, 1W	1V, 1mA, 1W
PROGRAMS	9x9 set of parameters	9x9 set of parameters	9x9 set of parameters
OUTPUTS	4 in parallel, 4mm sockets	4 in parallel, 4mm sockets	4 in parallel, 4mm sockets
MINIMUM LOAD RESISTANCE	5Ω	15Ω	70Ω
BUFFER DEPLETION DETECTION	on/off, programmable	on/off, programmable	on/off, programmable
NO LOAD DETECTION	on/off, programmable	on/off, programmable	on/off, programmable
GROUND LEAKAGE DETECTION	✓	✓	✓
OVERLOAD DETECTION	✓	✓	✓
COMPUTER CONTROL	✓	✓	✓
DATA/LOGGING	3600 values	3600 values	3600 values
RS232	9600b/s	9600b/s	9600b/s
AMBIENT TEMPERATURE	0...40°C	0...40°C	0...40°C
RELATIVE HUMIDITY	0...95%, non condensing	0...95%, non condensing	0...95%, non condensing
POWER REQUIREMENTS	210...250VAC, 50/60Hz, 360W	210...250VAC, 50/60Hz, 360W	210...250VAC, 50/60Hz, 360W
DIMENSIONS (WxDxH)	31x26x15cm	31x26x15cm	31x26x15cm
WEIGHT	10kg	10kg	10kg
	EV232	EV233	EV262
VOLTAGE	0...3000V	0...3000V	0...6000V
CURRENT	0...150mA	0...300mA	0...150mA
POWER	0...150W	0...300W	0...300W
PARAMETER RANGE	1...100% of full scale	1...100% of full scale	1...100% of full scale
TIMER	0...99:59h	0...99:59h	0...99:59h
VOLT-HOURS	0...99.99kVh	0...99.99kVh	0...99.99kVh
DISPLAY	LCD, 2x16 characters	LCD, 2x16 characters	LCD, 2x16 characters
RESOLUTION	1V, 1mA, 1W	1V, 1mA, 1W	1V, 1mA, 1W
PROGRAMS	9x9 set of parameters	9x9 set of parameters	9x9 set of parameters
OUTPUTS	4 in parallel, 2mm sockets	4 in parallel, 2mm sockets	4 in parallel, 2mm sockets
MINIMUM LOAD RESISTANCE	600Ω	300Ω	1200Ω
BUFFER DEPLETION DETECTION	on/off, programmable	on/off, programmable	on/off, programmable
NO LOAD DETECTION	on/off, programmable	on/off, programmable	on/off, programmable
GROUND LEAKAGE DETECTION	✓	✓	✓
OVERLOAD DETECTION	✓	✓	✓
COMPUTER CONTROL	✓	✓	✓
DATA/LOGGING	3600 values	3600 values	3600 values
RS232	9600b/s	9600b/s	9600b/s
AMBIENT TEMPERATURE	0...40°C	0...40°C	0...40°C
RELATIVE HUMIDITY	0...95%, non condensing	0...95%, non condensing	0...95%, non condensing
POWER REQUIREMENTS	210...250VAC, 50/60Hz, 200W	210...250VAC, 50/60Hz, 360W	210...250VAC, 50/60Hz, 360W
DIMENSIONS (WxDxH)	31x26x15cm	31x26x15cm	31x26x15cm
WEIGHT	6kg	10kg	10kg

Electrodialysis

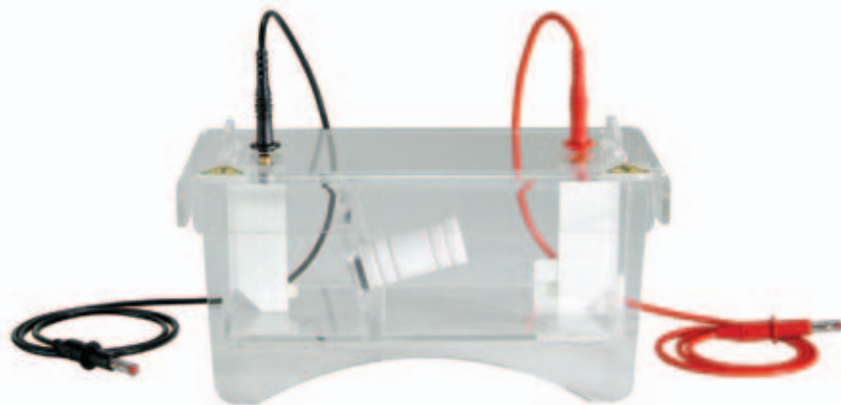

The ElectroPrep™

The ElectroPrep™ system from Harvard Apparatus is an extremely versatile patented sample preparation technology based on the principles of electrophoresis and dialysis. This ElectroPrep™ system is ideal for the rapid purification of proteins, nucleic acids, carbohydrates and other biological molecules.

With a run-time of 5 to 10 minutes, ElectroPrep™ provides speed and convenience, even at the very low 5 to 10mA currents used with this system. The sample chambers are made of Teflon, a completely inert material especially suited to high sample recovery. Membranes with molecular weight cut off points (MWCOs), ranging from 100 to 300,000 Daltons, may be used in combination with different Dialysis and Link Chambers for selective elution, filtration, dialysis, fractionation and concentration of complex samples, while Union chambers enable different Dialysis Chambers to be joined together to increase sample volume.

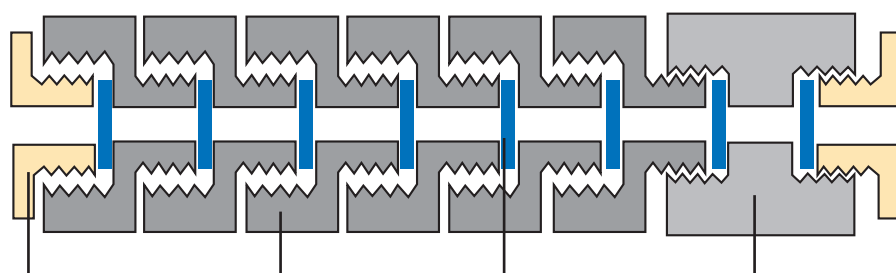

Teflon Caps - lock membranes into position, and, in their simplest format, are used to concentrate or desalt sample as shown in (iv) over the page.

Link Chamber - available in 25, 50, 100, 250 and 500µl volumes - can be connected to a Dialysis Chamber of greater volume to concentrate dialysed product, or can be joined in series with other link chambers and membranes of different MWCOs for the size-fractionation of different dialysed products

Membranes - with different MWCOs to accommodate biological molecules ranging from 100 to 300,000Da

Dialysis Chamber - the major receptacle for sample or dialysed product

BENEFITS INCLUDE

- **Fast dialysis times** - due to rapid movement of charged molecules in an electric field
- **Re-usable**
- **Different chambers** - for large or small sample volumes
- **Membranes available** - with MWCOs to suit almost any application or molecule size
- **Easy to use**
- **Leak proof**
- **Autoclavable**
- **Inert Teflon construction** - minimises non-specific protein and nucleic acid binding to the sample chamber, enhancing sample recovery
- **Highly versatile** - can be adapted for multiple dialysis applications

Applications

- Electroelution from gels and solutions - e.g. gel extraction of vector and insert during cloning
- Electrodialysis (with an average buffer exchange time of 5 to 10 minutes)
- On-line electrodialysis
- Electroconcentration
- Selective electrofiltration
- Size-fractionation of DNA and proteins from complex lysates
- Primer removal following PCR® amplification
- Salt removal from DNA mini-preps
- Detergent removal
- Dye-Terminator removal

TECHNICAL SPECIFICATION

Unit Dimensions (W x L x H)	12.5 x 25 x 14cm
Internal Dimensions (W x L x H)	9.5 x 20 x 8cm
Buffer Volume	1500ml
Recommended Running Conditions	5 to 10mA; 10 minutes run-time
Power Output Connectors (diameter)	Shrouded, 4mm
Recommended Power Supplies	Consort EV243

ORDERING INFORMATION

Unit Only

ElectroPrep™ Tank, including 4mm shrouded power connectors

Part No.

EP-74-1101

Replacement Parts & Accessories

2 x 1-metre power leads with shrouded 4 mm power output connectors

CABLE-4

See Tables 1a, 1b, 2a & 2b to order Dialysis Chambers, Link Chambers, Unions and Membranes

Electrodialysis

How to select your chamber and membrane configurations?

1. Decide upon your application - e.g. electroelution, electrofiltration, electrofiltration or electroconcentration
2. Select a Dialysis Chamber able to accommodate the desired sample volume - e.g. 50, 100, 200, 500, 1000 or 1500µl - N.B. a Dialysis Chamber can be joined to a Union to increase the sample volume
3. Choose membranes with the appropriate MWCO, depending on the technique being performed (see i to iv) and the molecular weight of the biological molecule of interest (dialysed product), taking into account each membrane's suitability for use in aqueous solutions or organic solvents
 - For organic solvents, use either regenerated cellulose or polycarbonate
 - For aqueous solutions, use cellulose acetate
4. Connect the Dialysis Chamber via a membrane and Union to another Dialysis Chamber for electrofiltration (i) or electroelution (ii); a Dialysis Chamber of smaller volume can also be attached to concentrate the dialysed product (iii)
5. When desalting PCR[®] products, membranes can be secured at each end of the Dialysis Chamber by Teflon end caps (iv)
6. Link chambers can be attached to the Dialysis Chamber via a membrane to filter samples according to their size; multiple link chambers can be used with different membranes for size-fractionation of different dialysed products

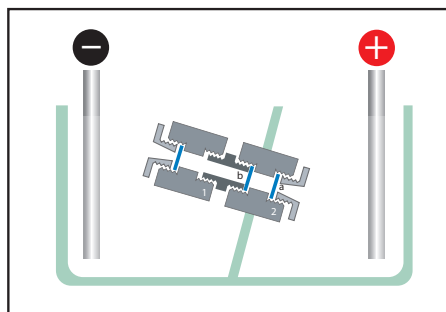

(i) Rapid and Selective Electro-Filtration / Concentration

The sample is placed in a compartment comprising the Dialysis Chamber (1) and the Union. The MWCO of membrane (b) is larger than the molecular weight of the biological molecule of interest, while the MWCO of membrane (a) is smaller. Upon application of the electric field, the biological molecule of interest will pass through membrane (b) and collect in Dialysis Chamber (2) while smaller molecules will pass through membranes (a) and (b) and Dialysis Chamber (2) as a result. This is a fast and effective method for the concentration of small samples as well as selective filtration.

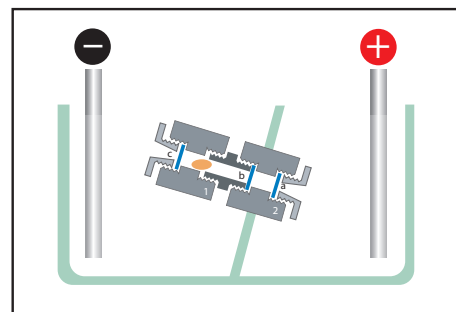
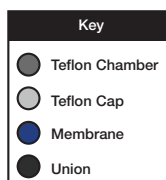

(ii) Gel extraction of DNA and protein by Electroelution

By using the ElectroPrep[™] system as shown in the schematic diagram, proteins and DNA can be eluted from a gel slice quickly and easily with excellent recovery. By using a Union, Dialysis Chambers can be joined in any combination necessary to accommodate the size of the gel slice. Samples can be concentrated if desired, by choosing a receiving chamber with a smaller volume. The MWCO of the membranes (a and b) can also be chosen to achieve very selective filtration. Membrane (b) should have a MWCO greater than the molecular weight of the sample of interest, while membranes (a) and (c) are smaller. The same principle applies as described in (i).

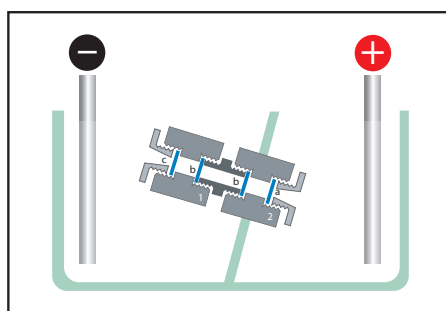
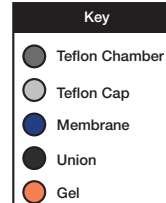

(iii) Selective Electro-Filtration / Concentration / Separation Based on Different Charges of Biological Molecules

In this configuration of the ElectroPrep[™], the sample is placed in a Union between two membranes (b), both of which should have a MWCO larger than the molecular weight of the molecule of interest, while the MWCOs of membranes (a) and (c) are smaller. Each biological molecule, including the molecule of interest, will then move either to Dialysis Chamber (1) or Dialysis Chamber (2), depending on its respective charge polarity (i.e. positive or negative), whereas those biological molecules with molecular weights lower than the sample of interest will migrate through membranes (a) and (c) into the tank. Biological molecules with unknown isoelectric points can also be separated and purified in this manner. Dialysis Chambers of smaller volumes can be used to concentrate dialysed product.

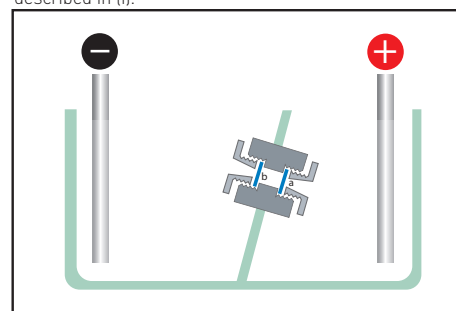
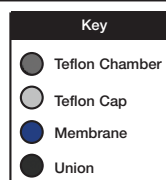

(iv) Electrodesialysis through Simultaneous Exchange of Buffers - e.g. cleaning up PCR[®] products

Following amplification, the PCR[®] product is placed in the Dialysis Chamber between membranes (a) and (b), each membrane having a MWCO lower than the molecular weight of the PCR[®] product but not the primer. Upon application of the electric field, dialysis occurs quickly by the simultaneous exchange of buffer, resulting in the migration of the lower molecular weight primers through membranes (a) and (b) while the purified PCR[®] product is retained in the Dialysis Chamber. Electrodesialysis is also effective for desalting neutral molecules that do not move in an electric field (such as sugars) or charged molecules at their isoelectric point.

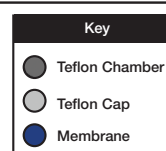

Membranes

Scie-Plas provides multiple membranes designed for use with different Dialysis Chambers, Link Chambers and Unions.

Cellulose Acetate

These membranes are low-protein-binding and have a sharp MWCO range. The membranes are pre-cut and supplied in 0.05% sodium azide solution. They are ready to use after rinsing with deionised water and buffer. Glycerol, sulphur, and heavy metals are not present in these membranes. Cellulose acetate membranes are intended only for aqueous solutions, and the presence of an organic solvent is not recommended.

Regenerated Cellulose

These membranes are more stable in organic solvents, but the MWCO range is not as sharply defined as that of cellulose acetate membranes. Regenerated Cellulose membranes are pre-cut, and supplied in a 0.05% sodium azide solution. They are ready to use after rinsing with deionised water and buffer. Glycerol, sulphur, or heavy metals are not present in these membranes.

Polycarbonate

These membranes are more stable in organic solvents. They are available in four highly controlled pore sizes for a well-defined MWCO range.

1a. Direct Compatibility Table to Connect Dialysis Chambers (50-200µl) and Link Chambers (25-100µl)

Dialysis Chamber			Union(s)				Link Chamber(s)		
Quantity	Volume	Part No.	Quantity	Volume	Part No.	See Option.	Quantity	Volume	Part No.
1	50µl	EP-74-0408	1	25-200µl to 25-200µl	EP-74-0100	A	1	25µl	EP-74-1619
5	50µl	EP-74-0400					5	25µl	EP-74-1620
1	100µl	EP-74-0409	OR				1	50µl	EP-74-1611
5	100µl	EP-74-0401					5	50µl	EP-74-1615
1	200µl	EP-74-0410	1	25-200µl to 250-1500µl	EP-74-0102	B	1	100µl	EP-74-1612
5	200µl	EP-74-0402					5	100µl	EP-74-1616

Option A: Use Union EP-74-0100 to connect together any two of the 50-200µl Dialysis Chambers [EP-74-0408 to EP-74-0402].

All 50-200µl Dialysis Chambers [EP-74-0408 to EP-74-0402] are directly compatible with all 25-100µl Link Chambers [EP-74-1619 to EP-74-1616].

Option B: Union EP-74-0102 is used to connect one 50-200µl Dialysis Chamber [EP-74-0408 to EP-74-0402] with one 500-1500µl Dialysis Chamber [EP-74-0411 to EP-74-0405].

All 500-1500µl Dialysis Chambers [EP-74-0411 to EP-74-0405] are directly compatible with all 250-500µl Link Chambers [EP-74-1613 to EP-74-1618].

1b. Membranes Compatible with 50-200µl Dialysis Chambers and 25-100µl Link Chambers

MWCO (kDa)	Cellulose Acetate Part No. 25/pack	Regenerated Cellulose Part No. 25/pack	Polycarbonate Part No. 25/pack
0.1	EP 7424-CA100		
0.5	EP 7424-CA500		
1	EP 7424-CA1K	EP 7427-RC1K	
2	EP 7424-CA2K	EP 7427-RC2K	
5	EP 7424-CA5K	EP 7427-RC5K	
10	EP 7424-CA10K	EP 7427-RC10K	
25	EP 7424-CA25K	EP 7427-RC25K	
50	EP 7424-CA50K	EP 7427-RC50K	
100	EP 7424-CA100K		
300	EP 7424-CA300K		
Membrane Pore Sizes			
0.01µM			EP 7431-PC01
0.05µM			EP 7431-PC05
0.10µM			EP 7431-PC10
0.6µM			EP 7431-PC60

2a. Direct Compatibility Table to Connect Dialysis Chambers (500-1500µl) and Link Chambers (250-500µl)

Dialysis Chamber			Union(s)				Link Chamber(s)		
Quantity	Volume	Part No.	Quantity	Volume	Part No.	See Option.	Quantity	Volume	Part No.
1	500 µl	EP-74-0411	1	250-1500µl to 250-1500µl	EP-74-1105	A	1	250µl	EP-74-1613
5	500µl	EP-74-0403					5	250µl	EP-74-1617
1	1000µl	EP-74-0412	OR				OR		
5	1000µl	EP-74-0404							
1	1500µl	EP-74-0413	1	25-200µl to 250-1500µl	EP-74-0102	B	1	500µl	EP-74-1614
5	1500µl	EP-74-0405					5	500µl	EP-74-1618

Option A: Use Union EP-74-1105 to connect together any two of the 500-1500µl Dialysis Chambers [EP-74-0411 to EP-74-0405].

All 500-1500µl Dialysis Chambers [EP-74-0411 to EP-74-0405] are directly compatible with all 250-500µl Link Chambers [EP-74-1613 to EP-74-1618].

Option B: Union EP-74-0102 is used to connect one 50-200µl Dialysis Chamber [EP-74-0408 to EP-74-0402] with one 500-1500µl Dialysis Chamber [EP-74-0411 to EP-74-0405].

All 500-1500µl Dialysis Chambers [EP-74-0411 to EP-74-0405] are directly compatible with all 250-500µl Link Chambers [EP-74-1613 to EP-74-1618].

2b. Membranes Compatible with 250-1500µl Dialysis Chambers and Link 250-500µl Chambers

MWCO (kDa)	Cellulose Acetate Part No. 25/pack	Regenerated Cellulose Part No. 25/pack	Polycarbonate Part No. 25/pack
0.1	EP 7425-CA100		
0.5	EP 7425-CA500		
1	EP 7425-CA1K	EP 7428-RC1K	
2	EP 7425-CA2K	EP 7428-RC2K	
5	EP 7425-CA5K	EP 7428-RC5K	
10	EP 7425-CA10K	EP 7428-RC10K	
25	EP 7425-CA25K	EP 7428-RC25K	
50	EP 7425-CA50K	EP 7428-RC50K	
100	EP 7425-CA100K		
300	EP 7425-CA300K		
Membrane Pore Sizes			
0.01µM			EP 7432-PC01
0.05µM			EP 7432-PC05
0.10µM			EP 7432-PC10
0.60µM			EP 7432-PC60

Scie-Plas VISION Gel Documentation System



BENEFITS INCLUDE

- **A self-explanatory simple to use system** - requiring no specialist on-site installation or training
- **Built in USB Drive** - allows rapid image saving and upgrading of software
- **High resolution images** - recorded in real time on an integrated colour LCD screen, using an 8-bit 768 x 582 pixel camera
- **Filter drawer with optional interchangeable filters** - capable of viewing a range of different fluorescent stains
- **UV-to-white light converter screen, 302 x 330mm** - for easy imaging of protein gels, autoradiographs and colony plates
- **Darkroom** - an ideal money-saving feature, universally compatible with all brands of standard mini bench top transilluminators
- **Maximum gel size** - 20 x 20cm - makes Vision the perfect gel documentation system for all standard Scie-Plas horizontal and vertical gel electrophoresis units, as well as most alternative brands
- **Save images in TIFF or BMP format** - via a USB connection either to a memory stick, network or WIFI
- **GeneTools Analysis Software** - saves time by automating analysis of gels, colony plates and blots
- **3-year warranty** - for complete peace of mind

The Scie-Plas VISION is a new compact imaging system for gel documentation, ideally suited to scientists who do not want another PC in their laboratory. Based on the latest image storage technology, VISION allows gel images to be printed instantly or saved on a USB memory stick for archiving or further processing. Also available is a network capability using either a WiFi or an ethernet connection. This easy to upgrade system comes complete with powerful GeneTools analysis software.

Using VISION is simple. The darkroom is designed to accommodate the most commonly available 20 x 20cm bench top transilluminators used to illuminate gels. Using a white light or blue light converter, VISION can be adapted to view and capture images as follows: -

- **Agar plates of dark, light or two-colour colonies**
- **Cells in flasks**
- **DNA, RNA or protein on membranes**
- **Spot and slot blots of DNA, RNA or protein**
- **Cells or solutions in microtitre plates**
- **DNA or protein macroarrays**

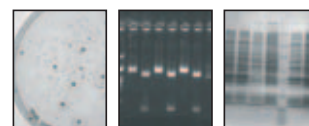

TECHNICAL SPECIFICATION

Camera	8-bit mono, 768 x 562 Pixels	
CCD	1/2 inch	
Zoom	8 - 48 manual zoom	
Lens	F1.2	
Exposure Control	0.04 - 10 seconds	
Detection Sensitivity	0.01ng	
Image Storage	USB	
Image Format	BMP or TIFF	
Transilluminator	Filter size	20 x 20cm
	Wavelength	302nm
	Variable intensity	50-100%
Compatible Dyes	Ethidium Bromide, Coomassie Blue, Silver Stain, SYBR® Gold, SYBR® Green, SYBR® Safe, GelStar®, Sypro® Red, Sypro® Ruby, Sypro® Orange, Fluorescein, Rhodamine Red™, Texas Red™, Pro Q® Diamond, Deep Purple™	

Deep Purple™ is a registered trademark of Amersham Biosciences Ltd. Pro Q®, SYBR®, Sypro®, Sypro®, Rhodamine Red™ and Texas Red™ are trademarks of Molecular Probes Inc. GelStar® is a trademark of FMC Corporation.

ORDERING INFORMATION

Complete System

Vision gel documentation system, including transilluminator, white light converter and GeneTools software for 230 Vac mains power supply

Vision gel documentation system, including transilluminator, white light converter and GeneTools software for 110 Vac mains power supply

Part No.

VISION

VISION-A

Replacement Parts & Accessories

1 x transilluminator, 302nm, 20 x 20cm

GVM20-E

1 x UV-to-white light converter, 302 x 330mm

CONVERTWHITE-2030



GeneTools Software

GeneTools is an advanced, but easy to operate, 1-D gel and 2-D spot blot analysis software that can be purchased either as part of the Scie-Plas Vision gel documentation system or separately for use with other gel documentation systems. An extensive and flexible array of analysis options enables GeneTools to handle a range of media, including gels, TLC plates, films and blots, while its many automated features allow gel images to be loaded, processed and quantified rapidly in as little as a few seconds.

ORDERING INFORMATION

Complete System

GeneTools analysis software

Part No.

GENETOOLS

BENEFITS INCLUDE

- **Compatible with multiple media formats** - horizontal and vertical gels; MADGE gels, films, ELISA and TLC plates; and dot and slot blots
- **Other applications comprise** - molecular weight/base pair; Rf and band quantity determination; colony counting; densitometry; spot blot and band matching
- **Software automation** - ensures rapid image generation and data acquisition
- **Automatic band matching and analysis of multi-layered gels** - simultaneous analysis of multiple well lines per gel
- **Automatic correction of background and band and dot distortion**
- **Automatic/manual marker assignment**
- **Integral molecular weight calibration library**
- **Full GLP reporting** - e.g. gel, lane, molecular weight, quantity and track histogram
- **Multiple data display options** - curves, bar charts, pie charts etc.
- **Results** - may be saved in Excel or *.CSV (comma-separated value) format for export

BENEFITS INCLUDE

- **Four 15-Watt UV-C bulbs** - generate sufficient high energy UV-C irradiation to denature nucleic acids in as little as 30 minutes, minimising unwanted background contamination in PCR reactions
- **Optimal reflectors** - provide uniform irradiation of the whole work surface area within the cabinet
- **Timer-control** - affords the user total control over exposure time and UV-dosage
- **Timer override switch** - for constant UV-C irradiation
- **Safety interlocks** - immediately cut out the UV source when the side doors are opened, preventing accidental UV exposure
- **10mm optical acrylic** - acts as a safety barrier to UV-C and β radiation, allowing the cabinet to be used as a radiation work station if preferred
- **White light** - illuminates the work area when the cabinet is in use
- **Recommended for use with the RPP-TY6854 safety tray and RPP-TL6854 easy-clean tray liners (not included)**
- **Techne® thermal cyclers also available**



TECHNICAL SPECIFICATION

External Dimensions (W x D x H)	56 x 42 x 77cm
Internal Dimensions (W x D x H)	54 x 40 x 75cm
Thickness of Acrylic	10mm; confers protection against the UV-C wavelength and high energy β -emitters
UV-C Bulbs	4 x 15W; 254nm wavelength
White Light Bulb	1 x 15W; visible wavelength
Timer Control	0-120 minutes
Weight	19Kg
Universal Voltage Input	100-240VAC, 50/60Hz



The GLE-UVSC PCR® UV Sterilisation Cabinet

The Scie-Plas GLE-UVSC PCR® UV sterilisation cabinet provides effective decontamination of reagents and equipment before carrying out sensitive PCR® reactions, particularly when amplifying DNA sequences which are either in limited supply or of low copy number. Four timer-controlled 15-Watt UV-C bulbs enable the user to control the exposure time and dose of high energy UV-C irradiation required to denature nucleic acids that cause unwanted background contamination, while a timer override switch allows the UV source to remain on indefinitely if preferred. Safety interlocks switch-off the UV-C bulbs automatically when the cabinet side doors are opened, preventing accidental exposure to the UV source. The cabinet's construction from UV-C-impermeable 10mm acrylic also serves as an effective barrier against radioactive isotopes, allowing the user to work in complete safety with high energy β -emitters such as ^{32}P . A single white light bulb illuminates the work area when the cabinet is in use.

PCR is a registered trademark of Hoffman LaRoche Ltd.

ORDERING INFORMATION

Complete System

UV sterilisation cabinet with universal power supply

Part No.

GLE-UVSC

Replacement Parts & Accessories

1 x UV germicidal bulb, 15W, 254nm	34-0008-01
1 x PVC radiation safety tray, 68 x 54cm (W x L)	RPP-TY6854
25 x APET liners, 68 x 54cm (W x L)	RPP-TL6854

Techne[®] TC-3000 Thermal Cycler

The TC-3000 is the latest upgrade of the Techne[®] TC-312: one of the best selling, most reliable and inexpensive personal thermal cyclers available on today's market.

Designed specifically to meet the budgets and PCR[®] applications of research and teaching laboratories, the TC-3000 offers all the benefits of the TC-312 to ensure reproducible high performance, including rapid heating and temperature uniformity of the heating block; a robust, spring-loaded heated lid; PC control and fast-programming with free software upgrades. In addition to the TC-3000, Scie-Plas can also offer many other products from the Techne[®] range, including the TC-412 and TC-512 thermal cyclers, hybridisation incubators, Dri-Block[®] heaters, water baths, sample concentrators and biological stirrers. Contact sales@scie-plas.co.uk for a full Techne[®] product catalogue and quotation.

TECHNICAL SPECIFICATION

Programming

Number of Programs	99 (3 segment programs)
Alphanumeric Key Pad	Yes
Program Naming Capability	Alphanumeric
Program Password Protection	Yes
Display	Large 4-line alphanumeric
Maximum Number of Segments/Loops	80
Maximum Number of Repeat Cycles per Program	99
End of Program Alarm	Yes (can be disabled)
Pause Facility	Yes
Incremental/Decremental Timing & Temperature	Yes
Auto Restart on Power Failure	Yes
Run End Time Calculation	Yes
Variable Programmable Ramp Rate Steps	± 0.1°C/sec

Connections and Dimensions

Serial Port RS 232 Socket	Yes
Voltage Selection Switch	Yes
Power Supply	230W
Dimensions (W x L x H)	185 x 305 x 190mm
Footprint	No more than 565cm ²
Net Weight	No more than 5Kg

Block Temperature

No of 0.2ml Wells	25
No of 0.5ml Wells	20
Colour of Wells	Blue/Black
Block Temperature Range	4°C to 99°C
Heating Ramp Rate*	3.6°C/sec minimum
Cooling Ramp Rate 0.2 ml block*	2.0°C/sec minimum
Cooling Ramp Rate 0.5 ml block*	1.8°C/sec minimum
Uniformity at 50 °C	0.2°C
Uniformity at 72 °C	0.4°C
Uniformity at 95 C	1.0°C
Accuracy at 50 °C	± 0.2°C
Accuracy at 72 °C	± 0.4°C
Accuracy at 95 °C	± 0.3°C
Temperature Set Point Adjustment	0.1°C
End of Program Cooling Below Ambient Temperature	Yes to 4°C

*Uniformity is the typical variation in temperature that may occur across the block under ambient conditions of 20°C

ORDERING INFORMATION

Complete System

	Part No.
TC-3000 thermal cycler for 25 x 0.2ml microtubes, 120V / 230V	FTC3/02
TC-3000 thermal cycler for 20 x 0.5ml microtubes, 120V / 230V	FTC3/05

Replacement Parts & Accessories

1 x TC-3000 block for 25 x 0.2ml microtubes	FTC3/02/B
1 x TC-3000 block for 20 x 0.5ml microtubes	FTC3/05/B
1 x PC connection to connect one thermal cycler to PC (RS232 ONLY), includes cable and software	FGEN232
1 x one cycler cable extension set	FGENONE
1 x two cycler cable set	FGENTWO
1 x four cycler cable set	FGENFOUR
1 x ten cycler cable set	FGENTEN
1000 x 0.2ml microtubes	FTUB02TW
1000 x 0.5ml thin walled microtubes	FTUB05TW



BENEFITS INCLUDE

- **Small, low cost** - of the world's best selling thermal cyclers, the TC-3000 is the smallest, most cost-effective unit on the market
- **Available in 25 x 0.2ml or 20 x 0.5ml microtube interchangeable block formats**
- **Fast-track programming with free software upgrades available from the Techne[®] website**
- **Ease of use** - with modern, intuitive programming and ready-to-go templates, creating even the most complicated protocols is simple
- **Reliable, high performance with quality guaranteed** - borne from 20 years' experience of manufacturing thermal cyclers
- **Portable Dual Voltage** - a compact, lightweight unit with a variable voltage selector ensures that it can be transported and used anywhere in the world
- **Unparalleled block uniformity** - ±0.1°C at 50°C, ensuring optimal reproducibility
- **Fast heating rate** - up to 3.6°C/sec heating rate and 2.0°C/sec cooling rate
- **Heated lid** - a selectable temperature range heated lid (+100°C to +115°C) is sprung to fit both 0.2ml domed and 0.5ml flat top tubes
- **Smallest footprint yet** - at only 561cm², the TC-3000 is economical on space
- **PC control & networking** - can be networked together with other Techne[®] cyclers allowing up to 32 cyclers to be connected to one PC
- **Password protection** - protects programs against unwanted modifications
- **4-year warranty**



Biostep Transilluminators

Scie-Plas is pleased to offer the best selling products from the Biostep transilluminator range. Biostep transilluminators, which are available in single and dual wavelength formats corresponding to the 254, 312 and 365nm UV wavebands.

- **K-type** - a basic, switch on/off model with constant UV intensity
- **E-type** - a basic, switch on/off model with a 50/100% UV intensity switch
- **R-type** - a basic, switch on/off model with a manual, variable 10 to 100% UV intensity setting
 - S-case - 325 x 322 x 105mm (W x D x H)

ORDERING INFORMATION

Replacement Parts & Accessories	Part No.
1 x 8 Watt tube, 254nm	BU55-W0103
1 x 8 Watt tube, 312nm	BU55-W0203
1 x 8 Watt tube, 365nm	BU55-W0403
1 x 2-sided UV protection shield for transilluminators	BU01-W8703
1 x 4-sided UV protection shield for transilluminators	BU01-W8705
1 x white-yellow UV conversion screen, 24 x 22cm (L x W)*	BC23-T2422
1 x white-yellow UV conversion screen, 32 x 27cm (L x W)*	BC23-T3227
1 x UV-transparent spot/band excision plate, 24 x 22cm (L x W)	BU53-W2422
1 x UV-transparent spot/band excision plate, 32 x 27cm (L x W)	BU53-W3227

*Suitable for gels stained with Coomassie® Blue, AmphiBlue® and Silver Stain; autoradiograms and other transparent templates

TECHNICAL SPECIFICATION & ORDER INFORMATION

Single Wavelength UV Transilluminators, S-case

Type	Filter Size	Wavelength	UV Tubes	Other Features	Part No.
E	20 x 20cm	254nm	8 x 8 Watt	<ul style="list-style-type: none"> homogeneous illumination high-quality reflector and optimal tube positioning excellent proof sensitivity integrated cooling increases tube lifespan 	UST-20S-8E
R	20 x 20cm	254nm	8 x 8 Watt	<ul style="list-style-type: none"> homogeneous illumination high-quality reflector and optimal tube positioning excellent proof sensitivity integrated cooling increases tube lifespan 	UST-20S-8R
K	20 x 20cm	312nm	6 x 8 Watt	<ul style="list-style-type: none"> homogeneous illumination 	UST-20M-8K
E	20 x 20cm	312nm	8 x 8 Watt	<ul style="list-style-type: none"> homogeneous illumination high-quality reflector and optimal tube positioning excellent proof sensitivity integrated cooling increases tube lifespan 	UST-20M-8E
R	20 x 20cm	312nm	8 x 8 Watt	<ul style="list-style-type: none"> homogeneous illumination high-quality reflector and optimal tube positioning excellent proof sensitivity integrated cooling increases tube lifespan 	UST-20M-8R
E	23 x 30cm	312nm	12 x 8 Watt	<ul style="list-style-type: none"> homogeneous illumination high-quality reflector and optimal tube positioning excellent proof sensitivity integrated cooling increases tube lifespan 	UST-30M-8E
R	23 x 30cm	312nm	12 x 8 Watt	<ul style="list-style-type: none"> homogeneous illumination high-quality reflector and optimal tube positioning excellent proof sensitivity integrated cooling increases tube lifespan 	UST-30M-8R
K	20 x 20cm	365nm	6 x 8 Watt	<ul style="list-style-type: none"> homogeneous illumination 	UST-20L-8K
E	20 x 20cm	365nm	8 x 8 Watt	<ul style="list-style-type: none"> homogeneous illumination high-quality reflector and optimal tube positioning excellent proof sensitivity integrated cooling increases tube lifespan 	UST-20L-8E
R	20 x 20cm	365nm	8 x 8 Watt	<ul style="list-style-type: none"> homogeneous illumination high-quality reflector and optimal tube positioning excellent proof sensitivity integrated cooling increases tube lifespan 	UST-20L-8R

Dual Wavelength UV Transilluminators, S-case

Type	Filter Size	Wavelength	UV Tubes	Other Features	Part No.
K	20 x 20cm	254 / 312nm	4 x 8 Watt / 4 x 8 Watt	<ul style="list-style-type: none"> homogeneous illumination 	USDT-20SM-8K
E	20 x 20cm	254 / 312nm	4 x 8 Watt / 4 x 8 Watt	<ul style="list-style-type: none"> homogeneous illumination high-quality reflector and optimal tube positioning excellent proof sensitivity integrated cooling increases tube lifespan 	USDT-20SM-8E
R	20 x 20cm	254 / 312nm	4 x 8 Watt / 4 x 8 Watt	<ul style="list-style-type: none"> homogeneous illumination high-quality reflector and optimal tube positioning excellent proof sensitivity integrated cooling increases tube lifespan 	USDT-20SM-8R
K	20 x 20cm	254 / 365nm	4 x 8 Watt / 4 x 8 Watt	<ul style="list-style-type: none"> homogeneous illumination 	USDT-20SL-8K
K	20 x 20cm	312 / 365nm	4 x 8 Watt / 4 x 8 Watt	<ul style="list-style-type: none"> homogeneous illumination 	USDT-20ML-8K
E	20 x 20cm	312 / 365nm	4 x 8 Watt / 4 x 8 Watt	<ul style="list-style-type: none"> homogeneous illumination high-quality reflector and optimal tube positioning excellent proof sensitivity integrated cooling increases tube lifespan 	USDT-20ML-8E
R	23 x 30cm	312 / 365nm	6 x 8 Watt / 6 x 8 Watt	<ul style="list-style-type: none"> homogeneous illumination high-quality reflector and optimal tube positioning excellent proof sensitivity integrated cooling increases tube lifespan 	USDT-30ML-8R

For a 110VAC electrical system add -A to the end of the Part No.





Radiation Protection

Radioactive compounds have been used in research laboratories for many years and the results of this research have benefited mankind considerably. In life science research radioactive compounds are used in the detection of nucleic acids and proteins, as well as in other techniques such as radioimmunoassay and as tracers in metabolic studies. The most commonly used isotopes which emit Beta (β) radiation particles are [^{32}P] phosphorus, [^{35}S] sulphur, [^{14}C] carbon and [^3H] tritium, while [^{125}I] iodine, [^{133}Xe] xenon, [^{57}Co] cobalt, [$^{99}\text{Tc}_m$] technetium, [^{123}I] iodine and [^{67}Ga] gallium emit Gamma (γ) particles.

Radiation Protection

BOXES are ideal for storage of racked samples or contaminated accessories

SHIELDS models for sitting; models for standing. Compatible with safety trays.

STORAGE and TRANSPORT BLOCK are ideal handling Eppendorf tubes available for Beta and Gamma radiation protection

WORK RACKS and RACK INSERTS fit both Gamma and Beta storage blocks

SAFETY TRAYS provide surface protection, spill containment and a clearly defined work area

TIP-BINS and WASTE BINS are a convenient solution for the disposal of small contaminated items



SAFETY PRECAUTIONS

12mm thick lead-acrylic is suitable only for the protection of Gamma emissions from ^{125}I and not from higher energetic isotopes of iodine. Lead or lead-acrylic is not recommended for shielding Beta emissions. When a Beta particle collides with an atom of a higher atomic number, such as lead, a hazardous X-ray like emission known as BREMSSTRAHLUNG is generated. To avoid producing significant amounts of bremsstrahlung, use only optical clear acrylic products to shield Beta emissions.

Radiation Protection

Generally, Beta emissions are negatively charged particles (electrons) emitted from the nucleus of an atom. Depending on the particular atom, the energy level of the charged particle will vary. Phosphorus is regarded as having a high energy level of Beta radiation particles, being 10 times greater than that of tritium, which can travel up to seven metres in air. Phosphorus is therefore known as a "hard" emitter of Beta radiation, while tritium, sulphur and carbon are regarded as "soft" emitters of Beta radiation.

^{125}I Iodine is a weak emitter of Gamma radiation particles. Gamma emissions are a form of electromagnetic radiation, similar to that of light generated by the nuclear decay of an unstable isotope. They are much more penetrating than Beta emissions and can travel very long distances in air.



Scie-Plas Limited manufacture the complete range of radiation protection products shown in this catalogue. Many styles and sizes of apparatus are listed for use with different applications.

BETA PROTECTION PRODUCTS

Beta emissions of ^{32}P , ^{35}S , ^3H and ^{14}C can be effectively blocked by using 10mm thick optical acrylic, which is now the accepted standard for shielding Beta emissions in biological research. The properties of this acrylic material are ideal for the construction of Beta radiation protection products. It is easy to bend, fabricate and machine into a wide range of products. Also, being transparent, the visibility of the working environment is not impaired.



GAMMA PROTECTION PRODUCTS

Protection from Gamma emitting isotopes such as ^{125}I , ^{133}Xe , ^{57}Co , ^{99}Tcm , ^{123}I and ^{67}Ga has, until recently, been achieved by lead shielding. This has its obvious disadvantages, being very heavy and non-transparent. However, a new lead containing acrylic copolymer resin is 30% wt/wt and is chemically introduced into the acrylic resin as an organolead salt. This material is transparent with a very light brown tint and it exhibits virtually all the normal chemical and physical properties of conventional acrylic resin.

Scie-Plas Limited provide a range of products using 12mm thick lead-acrylic, which is equivalent to 0.5mm thick lead. This range of products effectively blocks Gamma emissions from ^{125}I and any Gamma emitters of lesser energy. It is NOT suitable for use with more energetic isotopes of iodine. However, a 35mm thick shield is available which is equivalent to 1.7mm thick lead. This can be used with isotopes of higher energy



Radiation Protection

BENEFITS INCLUDE

- 10mm clear optical acrylic or 12mm lead acrylic for unobstructed view
- Choice of angle to suit location
- Most shields available in two sizes - small and large
- Large flat base models for under-bench protection
- Curved base models are compatible with Scie-Plas safety tray



TECHNICAL SPECIFICATION

	Dimensions (upright and horizontal)
Beta 10mm acrylic	
Gamma 12mm lead acrylic	
RPP-S015	540 x 350mm
Base	350 x 540mm
RPP-GS015	540 x 350mm
Base	350 x 540mm

Shielding

Many different styles and sizes of shield are available depending on the requirements of the user. Most shields are available in two sizes, small 450 x 300mm and large 530 x 350mm, and have either a large flat base, 300mm deep, for under-bench protection or a curved base, 120mm deep, for use with a Scie-Plas safety tray.

Adjustable 0 to 15° angle

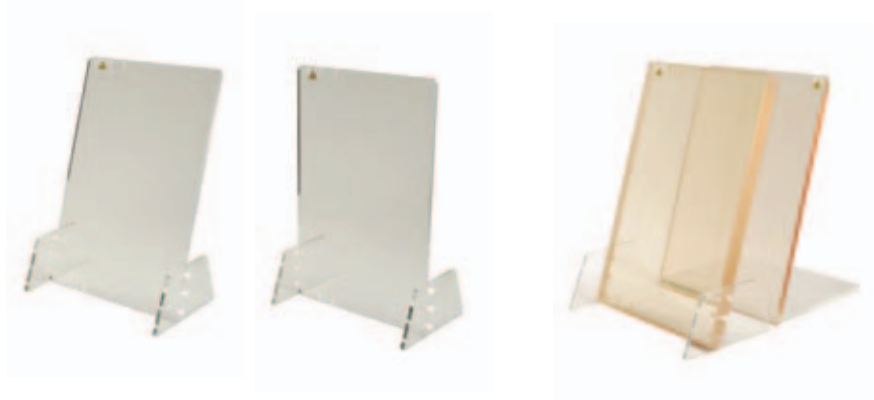

These shields are easily adjusted from an upright position to an angle of 15° depending on the application required. They can also be used in either wide or a tall position. When configured in a horizontal position, it creates a convenient side shield. The standard 12mm thick Gamma shield can be used with ¹²⁵I

ORDERING INFORMATION

Adjustable angle Beta shield	RPP-S015
Adjustable angle 12mm thick Gamma shield	RPP-GS015



Fixed Angle Shielding

Fixed 15° angle shields provide clear, non-distorted vision, reducing light images and shadows especially when the user is in a seated position. They are available in two sizes, small or large, with either a large flat base to provide under bench protection or a curved base, which fits conveniently over safety trays.

ORDERING INFORMATION

Small fixed	15° angle shield - flat base,	Beta	RPP-S15S
Small fixed	15° angle shield - flat base,	Gamma	RPP-GS15S
Small fixed	15° angle shield - curved base,	Gamma	RPP-GS15SC
Large fixed	15° angle shield - flat base,	Beta	RPP-S15L
Large fixed	15° angle shield - curved base,	Beta	RPP-S15LC
Large fixed	15° angle shield - flat base,	Gamma	RPP-GS15L
Large fixed	15° angle shield - curved base,	Gamma	RPP-GS15LC

Hourglass Shields



Hourglass shields have identical features to the fixed 15° angle shields but are cut in an hourglass shape. The curved sides provide the user with easier access to the central area behind the shield.

ORDERING INFORMATION

Hourglass shield - flat base,	Beta	RPP-SH
-------------------------------	-------------	--------

FEATURES AND BENEFITS

- 10mm clear optical acrylic or 12mm lead acrylic for an unobstructed view
- Most shields available in two sizes - small and large
- Large flat base models for under-bench protection
- Curved base models are compatible with Scie-Plas safety trays.

TECHNICAL SPECIFICATION

Beta 10mm acrylic Gamma 12mm lead acrylic	Dimensions (upright and horizontal)
RPP-S15S	450 x 300mm
Base	300 x 300mm
RPP-GS15S	450 x 300mm
Base	300 x 300mm
RPP-GS15SC	450 x 300mm
Base	150 x 300mm
RPP-S15L	530 x 350mm
Base	350 x 300mm
RPP-S15LC	530 x 350mm
Base	150 x 350mm
RPP-GS15L	530 x 350mm
Base	350 x 300mm
RPP-GS15LC	530 x 350mm
Base	150 x 350mm

TECHNICAL SPECIFICATION

Beta 10mm acrylic	Dimensions (upright and horizontal)
RPP-SH	450 x 300mm
Base	300 x 300mm

TECHNICAL SPECIFICATION

Beta 10mm acrylic Gamma 12mm lead acrylic	Dimensions (upright and horizontal)
RPP-S45S	450 x 300mm
Base	300 x 300mm
RPP-S45SC	450 x 300mm
Base	150 x 300mm
RPP-GS45SC	450 x 300mm
Base	150 x 300mm
RPP-S45L	600 x 350mm
Base	350 x 300mm

Fixed 45° Angle Shields

Fixed 45° angle shields provide clear, non-distorted vision reducing light images and shadows, especially when the user is in a standing position. They are available in two sizes, small or large, with either a large flat base to provide under bench protection or a curved base, which fits conveniently over safety trays.

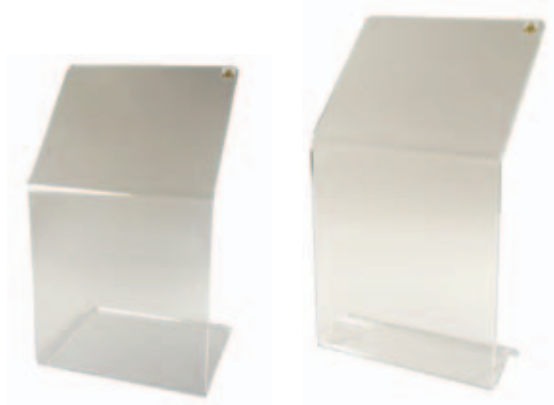

ORDERING INFORMATION

Small fixed 45° angle shield - flat base, Beta	RPP-S45S
Small fixed 45° angle shield - curved base Beta	RPP-S45SC
Small fixed 45° angle shield - curved base Gamma	RPP-GS45SC
Large fixed 45° angle shield - flat base Beta	RPP-S45L



TECHNICAL SPECIFICATION

Beta 10mm acrylic	Dimensions (upright and horizontal)
RPP-SB	500 x 460 x 300mm

3-Sided Shield



A 3-sided shield can be used with our range of Beta shields, providing further all round protection.

ORDERING INFORMATION

3-sided shield, Beta	RPP-SB
-----------------------------	--------

Storage Boxes



Beta Mini-Box with Hinged Lid

The smallest box in our range has a hinged lid and is ideal for storage when space is limited. Interchangeable box inserts are available for 16 x 1.5ml Eppendorf tubes.

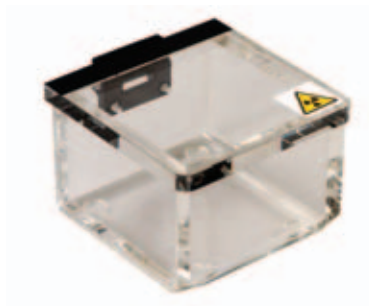

ORDERING INFORMATION

Mini-box with hinged lid, Beta	RPP-B5
Mini-box insert - 16 x 1.5ml Eppendorf tubes	RPP-BI-16

Midi-Boxes with Hinged Lids

The midi-box has a hinged lid and is designed to contain interchangeable inserts, which hold a double number of microcentrifuge tubes as the mini-box, as well as 32 x 2ml cryotubes. This model is available for either Beta or Gamma radiation protection.



ORDERING INFORMATION

Midi-box with hinged lid, Beta	RPP-B6
Midi-box with hinged lid, Gamma	RPP-GB6
Midi-box insert - 32 x 1.5ml Eppendorf tubes	RPP-BI-32

Scie-Plas Ltd manufactures a wide range of boxes and bins for the storage of samples and waste materials.

Interchangeable inserts between the boxes can hold a variety of vessels of different sizes. A range of heavy-duty waste bags with drawstrings for easy sealing are available to fit inside the waste bins.



TECHNICAL SPECIFICATION

Beta 10mm acrylic		Dimensions (H x W x D)
RPP-B5	Ext	75 x 105 x 105mm
	Int	55 x 85 x 85mm
RPP-BI-16		40 x 80 x 80mm

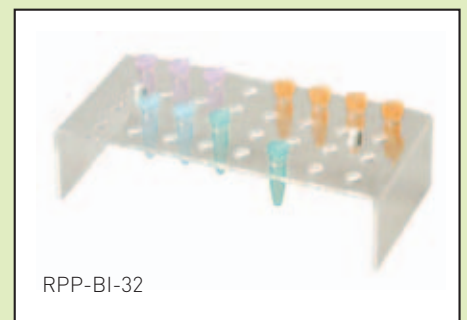

RPP-BI-32

TECHNICAL SPECIFICATION

Beta 10mm acrylic		Dimensions (H x W x D)
Gamma 12mm lead acrylic		
RPP-B6	Ext	80 x 185 x 105mm
	Int	60 x 165 x 85mm
RPP-GB6	Ext	84 x 189 x 109mm
	Int	60 x 165 x 85mm
RPP-BI-32		40 x 160 x 80mm

Maxi-Boxes with Hinged Lids



RPP-BI-6

TECHNICAL SPECIFICATION

		Dimensions (H x W x D)
Beta 10mm acrylic		
Gamma 12mm lead acrylic		
RPP-B14	Ext 160 x 300 x 185mm Int 140 x 280 x 165mm	
RPP-GB14	Ext 164 x 304 x 189mm Int 140 x 280 x 165mm	
RPP-BI-6	40 x 160 x 80mm	

TECHNICAL SPECIFICATION

	Dimensions (H x W x D)
Beta 10mm acrylic	
RPP-BX1	90 x 120 x 80mm

TECHNICAL SPECIFICATION

	Dimensions (H x W x D)
Beta 10mm acrylic	
RPP-STB	70 x 150 x 120mm



The maxi-box is designed to hold up to three midi-box inserts as well as inserts for taller tubes. This model is available for either Beta or Gamma radiation protection.

ORDERING INFORMATION

Maxi-box with hinged lids, Beta	RPP-B14
Maxi-box with hinged lids, Gamma	RPP-GB14
Maxi-box insert - 15 x 5ml scintillation vials	RPP-BI-6

Box with 2 "Pig Pens", Inserts and Hinged Lids



This box features two completely isolated chambers, each with their own hinged lid. Each chamber contains a removable insert for the safe support of vials.

ORDERING INFORMATION

2 pig-pen box, Beta	RPP-BX1
----------------------------	---------

Storage and Transport Block



A storage and transport block manufactured from solid acrylic specifically machined to accept 24 x 1.5ml and 15 x 0.5ml Eppendorf tubes.

ORDERING INFORMATION

Storage and transport box, Beta	RPP-STB
--	---------



Beta and Gamma Bins

Scie-Plas Ltd manufactures a range of bench-top bins for storing radioactive materials. All of the bins have hinged lids and cushioned anti-slip feet. Two large size Beta storage bins with hinged lids have wheels for easy manoeuvrability. Three sizes of bins are also available for Gamma radiation protection. A range of heavy-duty plastic bags with drawstrings are available to fit conveniently inside all of our bin sizes.

ORDERING INFORMATION

Bin-12, Beta (1L capacity)	RPP-B12
Bin-17, Beta (3.3L capacity) use waste bags RPP-BAG17	RPP-B17
Bin-17, Gamma (3.3L capacity) use waste bags RPP-BAG17	RPP-GB17
Bin-27, Beta (10L capacity) use waste bags RPP-BAG31	RPP-B27
Bin-27, Gamma (10L capacity) use waste bags RPP-BAG31	RPP-GB27
Bin-31, Beta (15L capacity) use waste bags RPP-BAG31	RPP-B31
Bin-42, Beta (50L capacity) use waste bags RPP-BAG42	RPP-B42
Bin-60, Beta (47L capacity) use waste bags RPP-BAG60	RPP-B60W
Bin-76, Beta (122L capacity) use waste bags RPP-BAG60	RPP-B76W



Waste Bins

- Suitable for low level radioisotope waste
- Hinged lid
- Durable PVC hinges

TECHNICAL SPECIFICATION

				Dimensions (H x W x D)
Beta 10mm acrylic	RPP-B12	Ext	150 x 120 x 100mm	
		Int	130 x 100 x 80mm	
Gamma 12mm lead acrylic	RPP-B17	Ext	170 x 170 x 170mm	
		Int	150 x 150 x 150mm	
Gamma 12mm lead acrylic	RPP-GB17	Ext	174 x 174 x 174mm	
		Int	150 x 150 x 150mm	
Beta 10mm acrylic	RPP-B27	Ext	270 x 220 x 220mm	
		Int	250 x 200 x 200mm	
Beta 10mm acrylic	RPP-GB27	Ext	274 x 224 x 224mm	
		Int	250 x 200 x 200mm	
Beta 10mm acrylic	RPP-B31	Ext	315 x 235 x 255mm	
		Int	295 x 215 x 235mm	
Beta 10mm acrylic	RPP-B42	Ext	420 x 510 x 290mm	
		Int	400 x 490 x 270mm	
Beta 10mm acrylic	RPP-B60W	Ext	600 x 305 x 290mm	
		Int	580 x 285 x 270mm	
Beta 10mm acrylic	RPP-B76W	Ext	760 x 426 x 426mm	
		Int	740 x 406 x 406mm	

Radiation Protection

- For the disposal of used pipette tips - additional hole/cover reduces exposure.
- Small and large models
- Waste bags available for easy removal of contents
- Multi-tip boxes feature a slot in the lid, to allow disposal of tips from a multi-channel pipette

TECHNICAL SPECIFICATION

		Dimensions (H x W x D)
Beta 10mm acrylic		
Gamma 12mm lead acrylic		
2L	RPP-B15SC	Ext 150 x 150 x 150mm Int 130 x 130 x 130mm
2L	RPP-GB15SC	Ext 150 x 150 x 150mm Int 126 x 126 x 126mm

TECHNICAL SPECIFICATION

		Dimensions (H x W x D)
Beta 10mm acrylic		
RPP-BTB	Ext 95 X 315 X 400mm Int 75 x 295 x 280mm	

Boxes

Beta and Gamma tip boxes



Available for either Beta or Gamma radiation protection, these boxes have a hinged lid with a central hole/slot also covered by a smaller hinged lid. The central hole/slot reduces the exposure to radiation during pipetting procedures. Models are available for single or multi-tip disposal. Convenient disposable heavy-duty plastic bags are available.

ORDERING INFORMATION

Tip box-15, Beta (2L capacity) use waste bags RPP-BAG17	RPP-B15SC
Tip box-15, Gamma (2L capacity) use waste bags RPP-BAG17	RPP-GB15SC
Multi-tip box-15, Beta (2L capacity) use waste bags RPP-BAG17	RPP-B15SCMC
Multi-tip box-15, Gamma (2L capacity) use waste bags RPP-BAG17	RPP-GB15SCMC

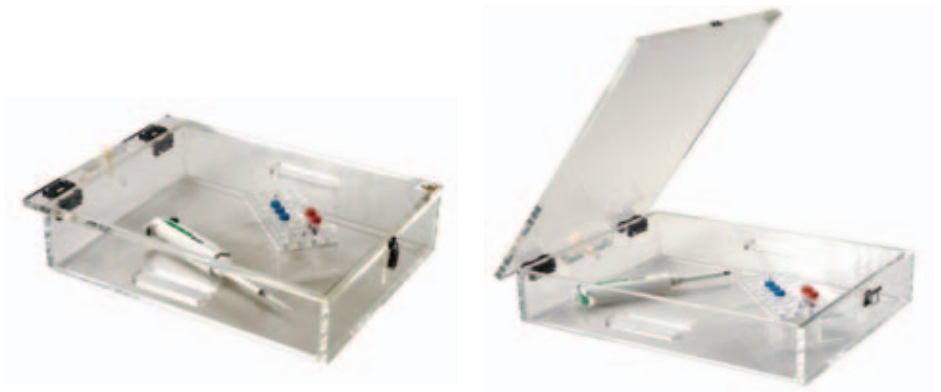

Beta Transit Box

This transit box combines a shield with a conveniently contained work area and storage container.

The hinged lid creates a 15° angled shield when fully open. The lid can be locked shut for safety while transporting the unit and its contents. Side handles are fitted for easy lifting and cushioned non-slip feet prevent slipping.

ORDERING INFORMATION

Transit box, Beta	RPP-BTB
--------------------------	---------

Beta Carboy Cover

A simple acrylic cover for the protection of carboys and laboratory equipment. An open base allows the cover to be placed over the container or equipment. It can also be removed without disturbing the container. A hinged lid provides easy access. The cover can be used in conjunction with a laboratory safety tray.



ORDERING INFORMATION

Carboy cover, **Beta**

RPP-CBC

Hazard Signs

A range of radiation hazard adhesive signs and tapes.

ORDERING INFORMATION

Radiation hazard symbol labels

25 x 25mm, pk/25

RPP-LAB25

Radiation hazard symbol labels

50 x 50mm, pk/50

RPP-LAB50

Radiation hazard tape, roll

25mm x 66m

RPP-TAPE



TECHNICAL SPECIFICATION

Beta 10mm acrylic

Dimensions
(H x W x D)

RPP-CBC

Ext 600 x 400 x 400mm
Int 590 x 380 x 380mm

Radiation Protection

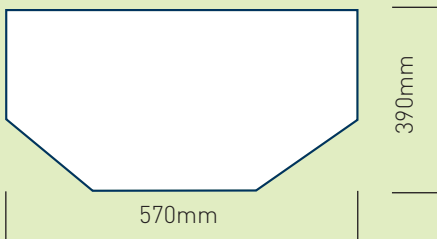
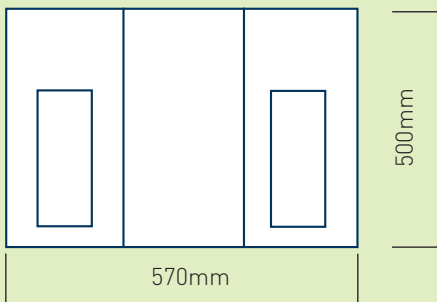

- **All-round protection for all operators and those working in nearby areas**
- **Compatible with Scie-Plas safety tray (not included)**
- **Ergonomically designed**
- **Hinged doors**

TECHNICAL SPECIFICATION

		Dimensions (H x W x D)
Beta 10mm acrylic		
Gamma 12mm lead acrylic		
RPP-C	Ext	500 x 570 x 390mm
	Int	490 x 550 x 370mm
RPP-GC	Ext	500 x 570 x 390mm
	Int	488 x 446 x 366mm



Cabinet Workstation

This cabinet has two large side doors to provide easy access for the user. It can also be used as a fully enclosed workstation. The dimensions are such that a sizeable working space is provided and the user's vision is unobstructed whether sitting or standing. A small cut-out at the rear of the unit enables services to be used inside the cabinet. When not in use, the doors can be closed and the unit used to store radioactive material.

The rear face features a convenient holder for two pipettes, which helps to keep the work surface clear, while services can be accessed through the cut-out at the base of the cabinet. The cabinet has no base in order for it to be used on a removable 5mm thick acrylic base tray. A suitable laboratory safety tray, RPP-TY6854 or RPP-TW6854, can also be used. Available for either Beta or Gamma radiation protection.

ORDERING INFORMATION

Cabinet, Beta	RPP-C
Cabinet, Gamma	RPP-GC
Base tray for cabinet, white 68 x 54cm	RPP-TW6854
Base tray for cabinet, yellow 68 x 54cm	RPP-TY6854
Tray liners for cabinet, pk/25 68 x 54cm	RPP-TL6854

Radiation Safety Bags

Heavy-duty, double heat-sealed 500 gauge polyethene with double sting neck pull. For use with Scie-Plas Beta and Gamma bins.

ORDERING INFORMATION

Bag 17	120 x 120 x 120mm, pk/25	RPP-BAG17
Bag 31	290 x 210 x 210mm, pk/25	RPP-BAG31
Bag 35	330 x 120 x 120mm, pk/25	RPP-BAG35
Bag 40	370 x 210 x 240mm, pk/25	RPP-BAG40
Bag 42	400 x 490 x 270mm, pk/25	RPP-BAG42
Bag 60	610 x 280 x 280mm, pk/25	RPP-BAG60







Safety Trays

Safety Trays and Liners

Unlike disposable paper bench protectors, Scie-Plas safety trays and tray liners are reusable. This reduces running costs and drastically reduces contaminated waste volume. The rigid PVC base features specially designed stabilising edges and rounded corners for easy cleaning. Additionally, the liner's non-porous surface allows valuable samples to be retrieved - something which is clearly not possible with absorbent paper protectors.

- Saves on running cost
- Contains liquid spillages
- Provides clearly defined work area
- Easily cleaned
- APET - environmentally friendly when incinerated
- Suitable for most hazardous spillages
- Anti-static and non-porous

ORDERING INFORMATION

	Tray Type	Ext Dimensions	Int Dimensions	Base only	APET Liners pk/25
 General Purpose		46 x 26cm	40.5 x 20cm	RPP-TW4626	RPP-TL4626
		54 x 34cm	46 x 26cm	RPP-TW5434	RPP-TL5434
		57 x 54cm	45.5 x 43cm	RPP-TW5754	RPP-TL5754
		68 x 54cm	56.5 x 42.5cm	RPP-TW6854	RPP-TL6854
		70 x 46cm	57 x 35cm	RPP-TW7046	RPP-TL7046
		113 x 54cm	100 x 42cm	RPP-TW11354	RPP-TL11354
		 Radiation Hazard		46 x 26cm	40.5 x 20cm
54 x 34cm	46 x 26cm			RPP-TY5434	RPP-TL5434
57 x 54cm	45.5 x 43cm			RPP-TY5754	RPP-TL5754
68 x 54cm	56.5 x 42.5cm			RPP-TY6854	RPP-TL6854
70 x 46cm	57 x 35cm			RPP-TY7046	RPP-TL7046
113 x 54cm	100 x 42cm			RPP-TY11354	RPP-TL11354
 Biohazard				46 x 26cm	40.5 x 20cm
		54 x 34cm	46 x 26cm	RPP-TO5434	RPP-TL5434
		57 x 54cm	45.5 x 43cm	RPP-TO5754	RPP-TL5754
		68 x 54cm	56.5 x 42.5cm	RPP-TO6854	RPP-TL6854
		70 x 46cm	57 x 35cm	RPP-TO7046	RPP-TL7046
		113 x 54cm	100 x 42cm	RPP-TO11354	RPP-TL11354

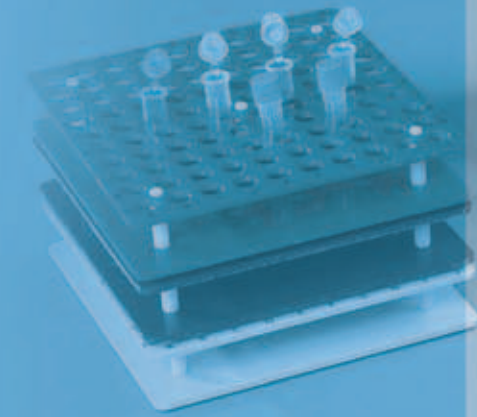

Laboratory Equipment

Serological Pipette Rack

These racks are for bench top storage of manual glass or plastic serological pipettes of 0.1ml to 25ml capacity. They have four angled compartments measuring 8 x 8 x 30cm. being fabricated from 5mm clear acrylic, stock levels of pre-packed pipettes can be constantly monitored. Additionally, each compartment can accept standard pipette cans and allow one-handed retrieval of pipettes when working in a biological hood.

ORDERING INFORMATION

Pipette rack - four shelves

GLE-PR

Coloured Tape Dispensers

Scie-Plas tape dispensers are ideal for easy one-handed access to popular coloured identification tapes. A serration on the dispensing edge allows the tape to be easily torn off. Each dispenser will take up to 12 rolls of the most popular 12.7mm wide tapes. Of smoked acrylic construction, two models are available for tapes of differing core diameters.

ORDERING INFORMATION

Small tape dispenser, tape core diameter 26mm

DISP26MM

Large tape dispenser, tape core diameter 76mm

DISP76MM

Glass Plate Racks

These sturdy racks are designed for safe drying and storage of glass plates. The small rack can hold up to twenty 2mm thick plates, while the larger rack can take up to ten 4mm thick glass plates.

ORDERING INFORMATION

Mini glass plate rack for twenty 2mm plates

GLE-MGR

Large glass plate rack for ten 4mm plates

GLE-LGR



Electrophoresis reagents, buffers, gels & membranes

Only available in EU Countries

Electrophoresis Reagents and Buffers

AGAROSE GEL REAGENTS AND BUFFERS

Agarose is a highly purified, naturally-occurring polysaccharide. The preparation of agarose gels involves simply heating the powdered agarose in buffer to dissolve it. It will then gel upon cooling. Like acrylamide the pore size of an agarose gel is inversely dependent on the agarose concentration. The pores in agarose gels are generally much larger than those in acrylamide gels, making them suitable for the separation of much larger nucleic acid fragments. There are many types of agarose available. The best choice for routine DNA electrophoresis is Agarose for DNA Electrophoresis (Catalogue Number 11404). This offers good gel strength and low impurities that might interfere with subsequent procedures.

This range of products has been continuously expanded and offers a variety of reagents for electrophoresis, including solid gel media, gel solutions, precast gels, ready-to-use buffers and solutions, as well as stains, dyes and markers.

Agarose, DNA Electrophoresis Grade

For analytical and preparative nucleic acid electrophoresis. Each batch is tested for the absence of EcoR1 inhibition.

Agarose, Electrophoresis Grade	100g	11404.03
Agarose, Electrophoresis Grade	500g	11404.07
Agarose, Electrophoresis Grade	1000g	11404.05

Agarose, Premium Molecular Biology Grade

Agarose, Molecular Biology Grade	100g	11381.02
----------------------------------	------	----------

TBE Buffer (10x)

TBE buffer is widely used in molecular biology and nucleic acid electrophoresis and has a higher buffering capacity than TAE buffer. It can be used for DNA and RNA, polyacrylamide and agarose gel electrophoresis. Supplied as a 10x concentrate. (0.89M Tris, 0.89M Boric Acid, and 0.02M EDTA in aqueous solution).

TBE Buffer, 10x	1L	42557.01
-----------------	----	----------

TAE Buffer (10x)

TAE buffer is used for the electrophoresis of nucleic acids. TAE has a lower buffering capacity than TBE, although linear dsDNA tends to run faster in TAE than in TBE buffer. Supplied as a 10x concentrate. (0.4M Tris, 0.2M Acetic Acid, 0.01M EDTA in aqueous solution).

TAE Buffer, 10x	1L	42553.01
-----------------	----	----------

DNA Marker, Lambda x BstE II

The Lambda x BstE II DNA marker contains 14 fragments, ranging from 117 to 8,454 bp: 117, 224, 702, 1264, 1371, 1929, 2323, 3675, 4324, 4822, 5687, 6369, 7242, and 8454 bp (the 5687 bp and 8453 bp fragments contain the cohesive ends of bacteriophage lambda and may hybridise resulting in a high molecular weight band at 14140 bp, although the ends may be separated by heating to 65°C for 5 minutes and placing on ice). Ideal for the analysis of DNA fragments generated from genomic or plasmid DNA.

DNA Marker, Lambda x BstE II	2 x 50µg	39301.01
------------------------------	----------	----------

Ethidium Bromide - Aqueous Solution, 1% w/v

Suitable for use in DNA isolation procedures and in the staining of DNA after electrophoresis. Concentration: 10mg/ml

Ethidium Bromide, Aqueous Solution, 1% w/v.	25ml	21251.01
---	------	----------

Ethidium Bromide Destaining Bags

Each bag will remove up to 5mg of Ethidium Bromide from solution, from an overnight preparation. The rate of destaining is improved if more destaining bags are added to the solution.



Ethidium Bromide - Destaining Bags	pk/5	90-1500
------------------------------------	------	---------

POLYACRYLAMIDE GEL REAGENTS AND BUFFERS

ACRYLAMIDE-BIS SOLUTIONS

The purity of acrylamide and bis-acrylamide is an important variable in gel electrophoresis. The most significant impurities are acrylic acid and polyacrylamide. The former can affect pH control in the gel while the latter influences the total polyacrylamide content of the gel and therefore its sieving properties. Since both of these can form on standing from highly purified material, especially with exposure to light, it is important to store these products protected from light and cold.

SERVA acrylamide solutions are prepared from powdered material which is subject to stringent quality control of the critical parameters in order to ensure consistent and reliable results.

Acrylamide-Bis Solution, 29:1, (40% w/v) 3.3% C

Solution of acrylamide and bis N,N'-methylenebisacrylamide in deionised water. Convenient to use, with reduced risk of exposure to neurotoxic acrylamide dust. Applicable to all electrophoresis techniques.

Acrylamide:Bis Solution, 29:1 (40% w/v)	500ml	10680.01
---	-------	----------

Acrylamide-Bis Solution, 37.5:1, (30% w/v) 2.6% C

Solution of acrylamide and bis N,N'-methylenebisacrylamide in deionised water. Convenient to use, with reduced risk of exposure to neurotoxic acrylamide dust. Applicable to all electrophoresis techniques.

Acrylamide:Bis Solution, 37.5:1 (30% w/v)	500ml	10688.01
---	-------	----------

REAGENTS AND BUFFERS

Ammonium Persulphate (APS), Analytical Grade

A high speed initiator used in polyacrylamide gel electrophoresis.

Ammonium Persulphate (APS)	50g	13375.01
----------------------------	-----	----------

N,N,N',N'-Tetramethylethylenediamide (TEMED)

Catalyses the formation of free radicals by ammonium persulphate and accelerates the polymerisation of acrylamide and bis-acrylamide.

TEMED	100ml	35925.01
-------	-------	----------

Laemmli Electrophoresis Buffer (10x)

A tris-glycine/SDS electrophoresis buffer supplied as a 10x concentrate for SDS-PAGE. (0.25M Tris, 1.92M Glycine and 1% SDS in aqueous solution).

Laemmli Buffer 10x	2L	42556.01
--------------------	----	----------

Tris-Glycine/SDS Sample Buffer (2x)

A tris-glycine/SDS sample buffer supplied as a 2x concentrate. (Tris-HCl pH 6.8, 126mM, glycerol 20%, SDS 4%, bromophenol blue 0.02%).

Tris-Glycine/SDS Sample Buffer, 2x	20ml	42527.01
------------------------------------	------	----------

Tris-Tricine/SDS Electrophoresis Buffer (10x)

A tris-tricine/SDS electrophoresis buffer supplied as a 10x concentrate for SDS-PAGE. (1M Tris, 1M Tricine and 1% SDS in aqueous solution).

Tris-Tricine/SDS Electrophoresis Buffer, 10x	1L	42552.01
--	----	----------

Tris-Tricine/SDS Sample Buffer (2x)

A tris-tricine/SDS sample buffer supplied as a 2x concentrate. (Tris-HCl pH 8.45, 90mM, Glycerol 24%, SDS 4%, SERVA Blue G 0.015%, Phenol Red 0.005%).

Tris-Tricine/SDS Sample Buffer, 2x	20ml	42551.01
------------------------------------	------	----------

Protein Marker, Unstained SDS-PAGE, 6.5 - 200 KDa, Liquid Mix

Ready to use for SDS-PAGE. Standard proteins ranging from 6.5 to 200 KDa. Protein content is approximately 0.15 to 0.3mg/ml.

Myosin	MW	200,000
B-Galactosidase	MW	116,000
Albumin Bovine (BSA)	MW	67,000
Ovalbumin	MW	45,000
Carbonic Anhydrase	MW	29,000
Trypsin Inhibitor (soybean)	MW	21,000
Lysozyme	MW	14,400
Aprotinin	MW	6,000
Protein Marker, 6.5 to 200KDa	500µl	39215.01

Colloidal Coomassie Blue (CCB)

Coomassie Blue G250 is widely used in visualising proteins separated by either agarose or acrylamide gel electrophoresis. This normally involves lengthy staining and destaining of gels using both glacial acetic acid and methanol. These solvents are both toxic and poisonous and need to be disposed as hazardous waste.

In order to avoid using these materials, Coomassie Blue G250 has been formulated into a colloid (CCB), which is both non-toxic and non-hazardous. The colloidal solution represents a safer way to apply the dye to the gels and is both easy and less expensive to use.

The CCB stain is applied to the gel after washing the gel with purified deionised water. The CCB solution is then agitated until the bands start to appear within the gel, any time from 20 minutes to two hours.

Once the bands appear and are of sufficient intensity, simply pour off the CCB stain and wash the gel in water. Keep washing until the background staining is removed and the protein bands appear more intense. This can be further enhanced by using CoZap™, a quick and easy destainer for Coomassie Blue.

Colloidal Coomassie Blue	1 L	30-38-10
--------------------------	-----	----------

CoZap™ Coomassie Blue Destainer

CoZap™ is used for the rapid removal of Coomassie Blue stain from electrophoresis gels without the need to change the destaining solution. CoZap™ is a unique pad that has high absorbance for Coomassie Blue and is thus very effective in destaining gels. CoZap™ absorbs any free dye in the solution, making gel destaining 20% faster than conventional methods.

BENEFITS INCLUDE

- No need to change the destaining solution
- Fast and simple
- No charcoal or dye residues
- No subsequent destaining required
- One pad can destain up to 10 gels
- 20% faster than conventional methods

CoZap™ - Coomassie Blue Destaining Pads, 76 x 76 x 2mm	pk/25	746800
CoZap™ - Coomassie Blue Destaining Pads, 76 x 76 x 2mm	pk/100	746801
CoZap™ - Coomassie Blue Destaining Pads, 38 x 76 x 2mm	pk/100	746802
CoZap™ - Coomassie Blue Destaining Pads, 38 x 76 x 2mm	pk/250	746803

Colloidal Coomassie Blue Staining Wash

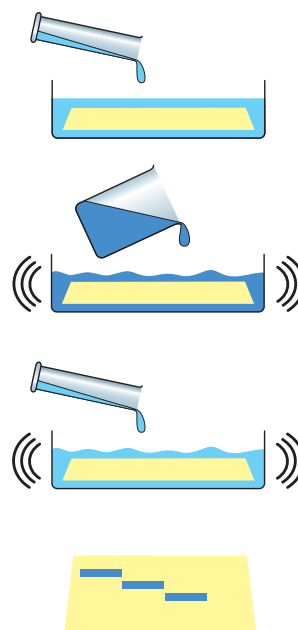

1

Wash

Wash Acrylamide or Agarose Gel with purified deionised water. Then dispose of water.

2

Stain

Add Colloidal Coomassie Blue Safe Stain and agitate Gel until discreet bands appear (20min - 2 hours). Then remove CCB stain.

3

Destain

Rinse the Gel with purified water and wash several times to remove background staining of Gel. Agitate or swirl to aid destaining of Gel until bands are distinct.

4

Observe

Pour off water, dry and observe bands.

Isoelectric Focusing

Isoelectric Focusing (IEF) is an ingenious process for simultaneous concentration and separation of proteins. IEF employs a pH gradient formed by small amphoteric molecules (ampholytes) to resolve proteins according to their different pI (isoelectric point) values. IEF is an end-point method; when the electrophoresis run is completed proteins will appear as separate sharp zones, in the order of their isoelectric point.

Scie-Plas offer the following products for IEF: -

SERVALYT™ Carrier Ampholytes

SERVALYT™ Carrier Ampholytes are low molecular weight molecules of zwitterionic character. They are a mixture of synthetically derived species of average molecular weight distribution of 400 to 1000 Da and comprise a multitude of varying pI values. In agarose and polyacrylamide gels containing ampholytes, a linear pH gradient is generated when an electric field is applied. The ampholyte molecules carry a net charge and thus migrate in the electric field between the electrodes until they reach the position of their corresponding pI, when they stop moving and form small plateaus (stationary stacks).

BENEFITS INCLUDE

- High resolution due to multimeric composition
- Fast staining and destaining times
- Clear background associated with very low unspecific binding of dyes and stains
- High solubility in trichloroacetic acid (fast removal of ampholytes during fixation)
- Virtually no interaction with metal ions



SERVALYT™ Carrier Ampholytes: Overview & Ordering Information

pH range	Cat. No.	Quantity	Cat. No.	Quantity
2-4	42902.01	10 ml	42902.02	25 ml
2-9 Seed Mix	42935.01 42935.03	10 ml 100 ml	42935.02	25 ml
2-11	42900.01	10 ml	42900.02	25 ml
3-4	42922.01	10 ml	42922.02	25 ml
3-5	42903.01	10 ml	42903.02	25 ml
3-6	42944.01	10 ml	42944.01	25 ml
3-7	42945.01	10 ml	42945.01	25 ml
3-10	42940.01	10 ml	42940.02	25 ml
3-10 Iso-Dalt *	42951.01	10 ml	42951.01	25 ml
4-5	42923.01	10 ml	42923.02	25 ml
4-6	42904.01	10 ml	42904.02	25 ml
4-7	42948.01	10 ml	42948.02	25 ml
4-9 T **	42910.01 42910.03	10 ml 100 ml	42910.02	25 ml
5-6	42924.01	10 ml	42924.02	25 ml
5-7	42905.01	10 ml	42905.02	25 ml
5-7 PGM	42936.01	10 ml	42936.02	25 ml
5-8	42949.01	10 ml	42949.02	25 ml
5-9	42950.01	10 ml	42950.02	25 ml
6-7	42925.01	10 ml	42925.02	25 ml
6-8	42906.01	10 ml	42906.02	25 ml
6-9	42913.01	10 ml	42913.02	25 ml
7-9	42907.01	10 ml	42907.02	25 ml
9-11	42909.01	10 ml	42909.02	25 ml

* Iso-Dalt quality; special 2-D grade to be used in 2-D electrophoresis

** Technical grade quality for preparative work

Precast Gels for Isoelectric Focusing

With SERVALYT™ PRECOTES™ precast gels, the days of elaborate, inconvenient casting of gels are gone. Scie-plas offers ready-to-use polyacrylamide gels for horizontal IEF that are simple to handle and reliable in performance.

The polyacrylamide layer is bonded to a sturdy, inert polyester support film and protected from damage and drying out by a thin cover sheet. The polymer concentration is 5% and cross-linking is 3%.

BENEFITS INCLUDE

- **Reliable, reproducible results**
- **Easy to use**
- **Thin (0.3mm) and Ultra-thin (0.15mm) gels**
- **3 Gel formats, Large - 245 x 125mm, Standard - 125 x 125mm, Mini - 45 x 50mm (width x height)**
- **Mini gels, compatible with automated electrophoresis units**
- **Long shelf life: over 12 months**

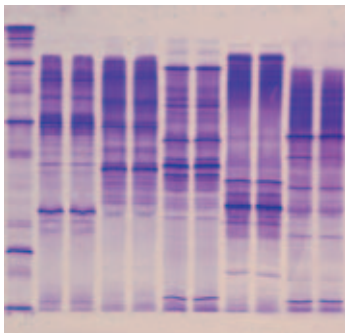

Meat

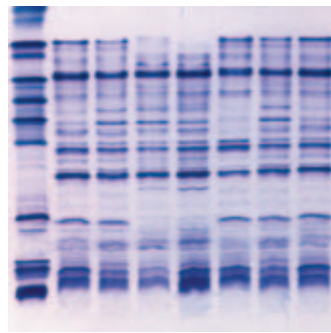

Potato

Blank SERVALYT™ PRECOTES™ Precast IEF Gels

Blank PRECOTES™ were developed to provide a versatile solution to perform isoelectric focusing of any pH range. The Blank PRECOTES™ are equilibrated in the ampholyte mixture of choice for 30 minutes prior to electrophoresis.

Blank PRECOTES™, Gel size 125 x 125 x 0.3mm, 5 gels	42759.01
Blank PRECOTES™, Gel size 245 x 125 x 0.3mm, 5 gels	42710.01

SERVALYT™ PRECOTES™ - Precast IEF Gels

SERVALYT™ PRECOTES™ pH 3 - 10 0.15mm thick, Size 125 x 125mm	5 gels	42965.03
SERVALYT™ PRECOTES™ pH 3 - 6 0.15mm thick, Size 125 x 125mm	5 gels	42974.02
SERVALYT™ PRECOTES™ pH 4 - 6 0.15mm thick, Size 125 x 125mm	5 gels	42975.02
SERVALYT™ PRECOTES™ pH 5 - 7 0.15mm thick, Size 125 x 125mm	5 gels	42979.02
SERVALYT™ PRECOTES™ pH 6 - 9 0.15mm thick, Size 125 x 125mm	5 gels	42978.02
SERVALYT™ PRECOTES™ pH 3 - 10 0.3mm thick, Size 125 x 125mm	5 gels	42866.02
SERVALYT™ PRECOTES™ pH 3 - 6 0.3mm thick, Size 125 x 125mm	5 gels	42874.02
SERVALYT™ PRECOTES™ pH 4 - 6 0.3mm thick, Size 125 x 125mm	5 gels	42875.02
SERVALYT™ PRECOTES™ pH 5 - 7 0.3mm thick, Size 125 x 125mm	5 gels	42879.02
SERVALYT™ PRECOTES™ pH 6 - 9 0.3mm thick, Size 125 x 125mm,	5 gels	42878.02
SERVALYT™ PRECOTES™ pH 3 - 10 0.15mm thick, Size 245 x 125mm	5 gels	42967.02
SERVALYT™ PRECOTES™ pH 3 - 6 0.15mm thick, Size 245 x 125mm	5 gels	42919.03
SERVALYT™ PRECOTES™ pH 4 - 6 0.15mm thick, Size 245 x 125mm	5 gels	42942.03
SERVALYT™ PRECOTES™ pH 6 - 9 0.15mm thick, Size 245 x 125mm	5 gels	42954.02
SERVALYT™ PRECOTES™ pH 3 - 10 0.3mm thick, Size 245 x 125mm	5 gels	42867.02



SERVALYT™ PRECOTES™ STARTER KIT

The SERVALYT™ PRECOTES™ STARTER KIT contains 3 x SERVALYT™ PRECOTES™ pH 3 - 10 precast gels, electrode wicks, applicator strips, anode and cathode solutions, Bayol F, SERVA Blue W tablets, lyophilised IEF marker 3 - 10 and instructions for IEF and staining.

SERVALYT™ PRECOTES™ Starter Kit	EACH	39060.01
------------------------------------	------	----------

PROTEIN MARKER FOR ISOELECTRIC FOCUSING

The Liquid Mix IEF Marker pH 3 - 10 is a ready-to-use protein marker especially developed for IEF applications. The marker is applicable to all horizontal and vertical IEF gels and can be used in both native and denaturing conditions (e.g. containing 8M). The marker is an ideal tool for the determination of the pI (isoelectric point) of unknown protein samples, but also for monitoring separation performance of IEF gels. The marker is supplied in 10% glycerol containing Bromophenol Blue (0.01%) and Methyl Red (0.01%).

BENEFITS INCLUDE

- Ready-to-use or lyophilised protein marker for isoelectric focusing
- For pI determination of unknown protein samples
- For monitoring the separation performance of IEF gels
- One standard applicable to all IEF gels (vertical/horizontal)
- No need for extra "High pI range" or "Low pI range" markers
- Purified protein components, salt-free
- 13 isoforms, featuring a characteristic pattern

Liquid IEF Marker pH 3 - 10 Ready-to-use	5mg	39212.01
Lyophilised IEF Marker pH 3 - 10	10mg	39211.01

ACCESSORIES FOR ISOELECTRIC FOCUSING

Applicator Strips

Four different applicator strips are available for dispensing samples.

Applicator Strips 2 x 3.5 19 slots, 100mm long	6 strips	42914.01
Applicator Strips 3.5 x 2 15 slots, 100mm long	6 strip	42915.01
Applicator Strips 7 x 1 24 slots, 260mm long	3 strips	42989.01
Applicator Strips 3.5 x 2 43 slots, 240mm long	3 strips	42899.01
Applicator Strip Kit One of each: 42914, 42915, 42989, 42899	4 strips	42937.01
Sample Application Pieces 10 x 5mm	200 pieces	42880.01

Electrode Wicks

Available in three sizes: Standard - 120 x 6 x 1mm, Long - 240 x 6 x 1mm and Extra - 300 x 6 x 1mm.

Electrode Wicks, Standard Size 120 x 6 x 1mm	100 pieces	42988.01
Electrode Wicks, Long Size 240 x 6 x 1mm	100 pieces	42987.03
Electrode Wicks, Extra Size 300 x 6 x 1mm	100 pieces	42972.03

Anode Fluid

0.17g L-aspartic acid / 0.18g L-glutamic acid in water.

Anode Fluid 3,	50ml	42984.03
----------------	------	----------

Cathode Fluid

0.22g L-arginine, 0.18g L-lysine, 6.0ml ethylenediamine in water.

Cathode Fluid 10	50ml	42986.03
------------------	------	----------

Other Reagents

Bayol F

Bayol F	100ml	14500.01
---------	-------	----------

Kerosene Pure

Kerosene	1 L	26940.01
----------	-----	----------

IPG BlueStrips - Dried gel strips with immobilised pH gradient

IPG BlueStrips are dried gel strips, incorporating an immobilised pH gradient, used in high resolution 2-D gel electrophoresis of proteins.

BENEFITS INCLUDE

- Stored at -20°C the gel strips are stable for at least 18 months
- Each package contains 12 gel strips, 3.0mm wide
- Consistent performance - 12 strips per package, all derived from the same production lot
- Reliability - accurate casting procedures ensures lot-to-lot reproducibility of pH gradients
- GMP/GLP conformity - each strip has its individual lot number

IPG Strips

IPG BlueStrip pH 3 - 10	7cm	12 strips	43001.01
IPG BlueStrip pH 3 - 10	18cm	12 strips	43011.01
IPG BlueStrip pH 3 - 10	24cm	12 strips	43021.01
IPG BlueStrip pH 3 - 10 NL*	7cm	12 strips	43002.01
IPG BlueStrip pH 3 - 10 NL*	18cm	12 strips	43012.01
IPG BlueStrip pH 3 - 10 NL*	24cm	12 strips	43022.01
IPG BlueStrip pH 4 - 7	7cm	12 strips	43003.01
IPG BlueStrip pH 4 - 7	18cm	12 strips	43013.01
IPG BlueStrip pH 4 - 7	24cm	12 strips	43023.01
IPG BlueStrip pH 6 - 10	7cm	12 strips	43004.01
IPG BlueStrip pH 6 - 10	18cm	12 strips	43014.01
IPG BlueStrip pH 6 - 10	24cm	12 strips	43024.01

* NL Non-Linear Gradient

Rehydration tray for IPG Strips

To rehydrate up to 12 IPG strips in lengths up to 24cm. The rehydration tray maintains its shape and is resistant against chemicals normally used to rehydrate IPG strips.

Rehydration Tray	Each	43091.01
------------------	------	----------



Precast PAGE Gels

VERTICAL PRECAST GELS FOR MINI VERTICAL ELECTROPHORESIS.

A novel range of precast gels, ready-to-use and cast from acrylamide-bis in unbreakable safety cassettes. The SERVAGel™ gives premium resolution and superb band sharpness. The 10 x 10cm format is compatible with many vertical electrophoresis units, particularly the TV50 and TV100 units. SERVAGel™ are packed single and vacuum sealed.

BENEFITS INCLUDE

- **Easy and safe to operate, no leakage**
- **Short set-up times, gels are ready to use**
- **Unbreakable, recyclable plastic cassette**
- **Minimum health risk (polymerised acrylamide, non-toxic)**
- **For gradient gels, please inquire**

SERVAGel™ TG 8 - Vertical Tris-Glycine Gel 8%

Storage Temperature +20°C to +80°C.

The SERVAGel™ TG 8 can be operated in the presence or absence of SDS (SDS-PAGE, native PAGE). The separation range is from 60 to 200KDa. Shelf life is 3 months.

SERVAGel™ TG 8 - Tris-Glycine Gel 8%	2 gels	43208.03
SERVAGel™ TG 8 - Tris-Glycine Gel 8%	6 gels	43208.02
SERVAGel™ TG 8 - Tris-Glycine Gel 8%	10 gels	43208.01

SERVAGel™ TG 10 - Vertical Tris-Glycine Gel 10%

Storage Temperature +20°C to +80°C.

The SERVAGel™ TG 10 can be operated in the presence or absence of SDS (SDS-PAGE, native PAGE). The separation range is from 25 to 200KDa.

Shelf life is 3 months.

SERVAGel™ TG 10 - Tris-Glycine Gel 10%	2 gels	43210.03
SERVAGel™ TG 10 - Tris-Glycine Gel 10%	6 gels	43210.02
SERVAGel™ TG 10 - Tris-Glycine Gel 10%	10 gels	43210.01

SERVAGel™ TG 12 - Vertical Tris-Glycine Gel 12%

Storage Temperature +20°C to +80°C.

The SERVAGel™ TG 12 can be operated in the presence or absence of SDS (SDS-PAGE, native PAGE). The separation range is from 15 to 100KDa.

Shelf life is 3 months.

SERVAGel™ TG 12 - Tris-Glycine Gel 12%	2 gels	43212.03
SERVAGel™ TG 12 - Tris-Glycine Gel 12%	6 gels	43212.02
SERVAGel™ TG 12 - Tris-Glycine Gel 12%	10 gels	43212.01

SERVAGel™ TG 14 - Vertical Tris-Glycine Gel 14%

Storage Temperature +20°C to +80°C.

The SERVAGel™ TG 14 can be operated in the presence or absence of SDS (SDS-PAGE, native PAGE). The separation range is from 10 to 90KDa.

Shelf life is 3 months.

SERVAGel™ TG 14 - Tris-Glycine Gel 14%	2 gels	43214.03
SERVAGel™ TG 14 - Tris-Glycine Gel 14%	6 gels	43214.02
SERVAGel™ TG 14 - Tris-Glycine Gel 14%	10 gels	43214.01

SERVAGel™ TG 16 - Vertical Tris-Glycine Gel 16%

Storage Temperature +20°C to +80°C.

The SERVAGel™ TG 16 can be operated in the presence or absence of SDS (SDS-PAGE, native PAGE). The separation range is from 7 to 80KDa.

Shelf life is 3 months.

SERVAGel™ TG 16 - Tris-Glycine Gel 16%	2 gels	43216.03
SERVAGel™ TG 16 - Tris-Glycine Gel 16%	6 gels	43216.02
SERVAGel™ TG 16 - Tris-Glycine Gel 16%	10 gels	43216.01

SERVAGel™ Neutral pH 7.4

Storage Temperature +20°C to +80°C.

The SERVAGel™ Neutral pH 7.4 can be operated with various buffer systems, such as Tris-Glycine, MOPS-Tris and Tris-Tricine. The separation range is from 6.5 to 200KDa.

Shelf life is 3 months.

SERVAGel™ Neutral pH 7.4	2 gels	43220.03
SERVAGel™ Neutral pH 7.4	6 gels	43220.02
SERVAGel™ Neutral pH 7.4	10 gels	43220.01

Blotting Buffers & Membranes

GEL BLOTTING PAPER - FN100

Gel blotting paper with an extremely smooth surface and a 0.35mm thickness. Made from the purest naturally occurring raw materials, offering the maximum degree of absorption and α cellulose content.

Fast running and high absorption capacity; ideal combination of chromatography and gel blotting paper. The ideal general purpose blotting paper for Southern, Northern and Western blotting, gel lifting, sequencing, buffer wicking and semi-dry blotting.

BENEFITS INCLUDE

- Superior uniformity across the entire contact area in the blotting transfer system
- Absorption and improvement in the transport of transfer buffer after capillary and semi-dry blotting
- Double-sided cover of gel and transfer membrane in the blotting tank after conventional electroblotting
- To prevent direct contact between the blotting membrane and porous cover plate of the vacuum chamber for dot/slot blotting of RNA and DNA

200 x 200mm	100 Sheets	FN100
-------------	------------	-------

Towbin Buffer, 10x, for Western Blotting

Supplied as a 10x concentrate: (0.25M Tris and 1.92M Glycine in aqueous solution.

Working buffer: dilute 100ml of 10x concentrate with 200ml of methanol and 700ml distilled water.

Towbin Buffer, 10x	1 L	42558.02
--------------------	-----	----------

Semi-Dry Blotting Buffer Kit

Supplied as a ready-to-use kit, comprising of 3 components for Western blotting in the semi-dry blotting units.

Buffer 1. [Conc. Anode buffer]: 0.3M Tris and 20% Methanol in aqueous solution.

Buffer 2. [Diluted Anode buffer]: 0.03M Tris and 20% Methanol in aqueous solution.

Buffer 3. [Cathode buffer]: 0.25M Tris/HCl (pH 9.4), 0.04M 6-Aminocaproic acid and 20% Methanol in aqueous solution.

Semi-Dry Blotting Buffer Kit	2 x 500ml	42559.01
------------------------------	-----------	----------

BLOTTING MEMBRANES

Scie-Plas offers 5 different types of blotting membrane for use with all transfer techniques. Each membrane is available in 10 x 10cm and 20 x 20cm formats and in 0.2 and 0.45 μ m pore sizes for the binding of low (<20kDa) and high (>20kDa) molecular weight proteins and nucleic acids.

Nitrocellulose Blotting Membranes

Nitrocellulose membranes are the most popular membranes for Western Southern and Northern blotting. The membranes bind both proteins and nucleic acids. Nitrocellulose exhibits high binding capacity and has low background.

0.02 μ m pore size, 100mm x 100mm	25 Sheets	EB-MEM-NC20
0.02 μ m pore size, 200mm x 200mm	25 Sheets	EB-MEM-NC20L
0.45 μ m pore size, 100mm x 100mm	25 Sheets	EB-MEM-NC45
0.45 μ m pore size, 200mm x 200mm	25 Sheets	EB-MEM-NC45L



Supported Nitrocellulose Blotting Membranes

As per nitrocellulose but more robust for frequent handling.

0.02 μ m pore size, 100mm x 100mm	25 Sheets	EB-MEM-SNC20
0.02 μ m pore size, 200mm x 200mm	25 Sheets	EB-MEM-SNC20L
0.45 μ m pore size, 100mm x 100mm	25 Sheets	EB-MEM-SNC45
0.45 μ m pore size, 200mm x 200mm	25 Sheets	EB-MEM-SNC45L

Polyvinylidene Fluoride (PVDF) Blotting Membranes

A hydrophobic membrane with much higher protein-binding capacity than nitrocellulose.

0.02 μ m pore size, 100mm x 100mm	25 Sheets	EB-MEM-PDVF20
0.02 μ m pore size, 200mm x 200mm	25 Sheets	EB-MEM-PDVF20L
0.45 μ m pore size, 100mm x 100mm	25 Sheets	EB-MEM-PDVF45
0.45 μ m pore size, 200mm x 200mm	25 Sheets	EB-MEM-PDVF45L

Supported Nylon-66 Blotting Membranes

A more versatile membrane, with reduced background to increase sensitivity, for the binding of nucleic acids after semi-dry blotting, capillary Southern and Northern transfer; more robust for frequent handling.

0.02 μ m pore size, 100mm x 100mm	25 Sheets	EB-MEM-SN20
0.02 μ m pore size, 200mm x 200mm	25 Sheets	EB-MEM-SN20L
0.45 μ m pore size, 100mm x 100mm	25 Sheets	EB-MEM-SN45
0.45 μ m pore size, 200mm x 200mm	25 Sheets	EB-MEM-SN45L

Positively Charged Supported Nylon-66 Blotting Membranes

Higher binding affinity than supported Nylon-66 for negatively charged molecules such as nucleic acids during Southern and Northern transfer; more robust for frequent handling.

0.02 μ m pore size, 100mm x 100mm	25 Sheets	EB-MEM-SN20
0.02 μ m pore size, 200mm x 200mm	25 Sheets	EB-MEM-SN20L
0.45 μ m pore size, 100mm x 100mm	25 Sheets	EB-MEM-SN45
0.45 μ m pore size, 200mm x 200mm	25 Sheets	EB-MEM-SN45L

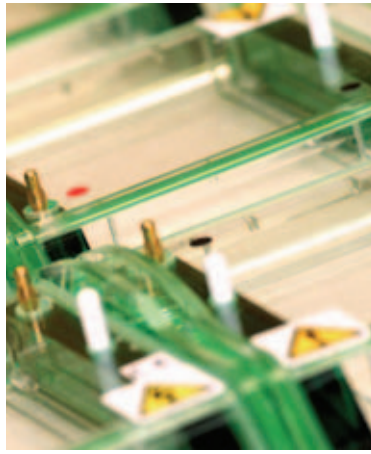
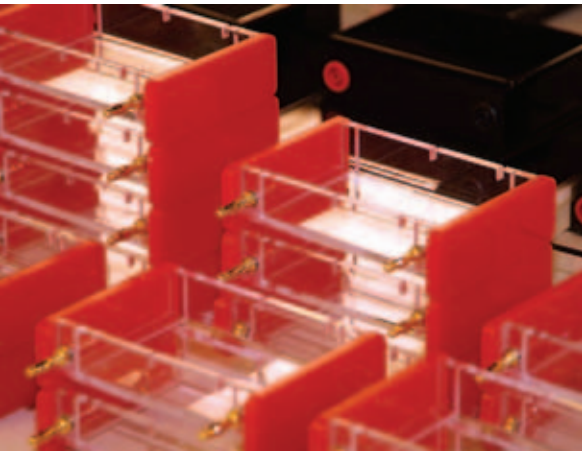

Terms and Conditions

Scie-Plas Limited Terms of Trading

Buyer: The person, firm or company who purchases Goods from the Company

Company: Scie-Plas (UK) Limited

Contract: any Contract between the Company and the Buyer for the sale and purchase of the Goods, incorporating these conditions

Goods: any Goods agreed in the Contract to be supplied to the Buyer by the Company (including any part or parts of them).

Company Warehouse: the warehouse of the Company at which deliveries will be effected pursuant to Clause 6.1, the location of which has been notified to the Buyer.

1 Price

- 1.1 The price quoted excludes VAT (unless otherwise stated). VAT will be charged at the rate applying at the time of delivery.
- 1.2 The Company's quotations lapse after thirty days (unless otherwise agreed).
- 1.3 The price quoted excludes delivery (unless otherwise stated).
- 1.4 Unless otherwise stated, the price quoted is an illustrative estimate only and the price charged will be the Company's price current at the time of delivery.
- 1.5 Rates of tax and duties on the Goods will be those applying at the time of delivery.
- 1.6 At any time before delivery the Company may adjust the price to reflect any increase in the costs of supplying the Goods.

2 Delivery

- 2.1 Any dates specified by the Company for delivery of the Goods are intended to be an estimate and time for delivery shall not be made of the essence by notice. If no dates are so specified, delivery shall be within a reasonable time.
- 2.2 If the Company fails to deliver within a reasonable time, the Buyer may (in writing) cancel the Contract, however:
 - 2.2.1 the Buyer may not cancel if the Company receives notice after the Goods have been despatched; and
 - 2.2.2 if the Buyer cancels the Contract, the Buyer can have no further claim against the Company under the Contract.
- 2.3 If the Buyer accepts delivery of the Goods after the estimated delivery time, it will be on the basis that the Buyer has no claim against the Company for delay (including indirect or consequential loss, or increase in the price of the Goods).
- 2.4 The Company may deliver the Goods by separate instalments. Each separate instalment shall be invoiced and paid for in accordance with the provisions of the Contract.
- 2.5 Each instalment shall be a separate Contract and no cancellation or termination of any one Contract relating to an instalment shall entitle the Buyer to repudiate or cancel any other Contract or instalment.

3 Delivery and safety

- 3.1 The Company may decline to deliver if:
 - 3.1.1 it believes that it would be unsafe, unlawful or unreasonably difficult to do so; or
 - 3.1.2 the premises (or the access to them) are unsuitable for the Company's vehicle.
- 3.2 Any liability of the Company for non-delivery of the Goods shall be limited to replacing the Goods within a reasonable time or issuing a credit note at the pro rata Contract rate against any invoice raised for such Goods.

4 Payment terms

- 4.1 The Buyer is to pay the Company cash (or otherwise in cleared funds such as by credit card) on delivery unless the Buyer has an approved credit account.
- 4.2 If the Buyer has an approved UK business credit account, payment is due 30 days from the invoice date, unless otherwise agreed in writing.
- 4.3 Time for payment shall be of the essence.
- 4.4 No payment shall be deemed to have been received until the Company has received cleared funds.
- 4.5 If the Buyer fail to pay the Company in full on the due date:
 - 4.5.1 the Company may suspend or cancel future deliveries;
 - 4.5.2 the Company may cancel any discount offered to the Buyer;
 - 4.5.3 the Buyer must pay the Company interest at the rate equivalent to that set for the purposes of section 6 of the Late Payment of Commercial Debts (Interest) Act 1998;
 - (i) calculated (on a daily basis) from the date of the Company's invoice until payment;
 - (ii) compounded on the first day of each calendar month; and
 - (iii) before and after any judgement (unless the court orders otherwise).
- 4.6 If the Buyer has an approved business credit account the Company may withdraw it or reduce the credit limit or bring forward the Buyer's due date for payment.
- 4.7 The Company may take any of those actions in 4.6 at any time and without notice.
- 4.8 The Buyer shall make all payments due under the Contract in full without any deduction whether by way of set-off, counterclaim, discount, abatement or otherwise unless the Buyer has a valid court order requiring an amount equal to such deduction to be paid by the Company to the Buyer.
- 4.9 While the Buyer owes money to the Company, the Company has a right to keep any property the Company may hold of the Buyer's until the money is paid to the Company in full.
- 4.10 The Buyer must indemnify the Company in full and hold the Company harmless from all expenses and liabilities the Company may incur (directly or indirectly and including legal costs on a full indemnity basis) following any breach by the Buyer of any of their obligations under these terms.

5 Title

- 5.1 Ownership of the Goods shall not pass to the Buyer until the Company has received in full (in cash or cleared funds) all sums due to it in respect of:
 - 5.1.1 the Goods; and
 - 5.1.2 all other sums which are or which become due to the Company from the Buyer on any account.
- 5.2 Until ownership of the Goods has passed to the Buyer, the Buyer shall:
 - 5.2.1 hold the Goods on a fiduciary basis as the Company's bailee;
 - 5.2.2 store the Goods (at no cost to the Company) separately from all other Goods of the Buyer or any third party in such a way that they remain readily identifiable as the Company's property;
 - 5.2.3 not destroy, deface or obscure any identifying mark or packaging on or relating to the Goods; and
 - 5.2.4 maintain the Goods in satisfactory condition and keep them insured on the Company's behalf for their full price against all risks to the reasonable satisfaction of the Company. On request the Buyer shall produce the policy of insurance to the Company.

- 5.3 The Buyer may resell the Goods before ownership has passed to it solely on the following conditions:
- 5.3.1 any sale shall be effected in the ordinary course of the Buyer's business at full market value; and
- 5.3.2 any such sale shall be a sale of the Company's property on the Buyer's own behalf and the Buyer shall deal as principal when making such a sale.
- 5.4 The Buyer's right to possession of the Goods shall terminate immediately if:
- 5.4.1 the Buyer has a bankruptcy order made against him or makes an arrangement or composition with his creditors, or otherwise takes the benefit of any statutory provision for the time being in force for the relief of insolvent debtors, or (being a body corporate) convenes a meeting of creditors (whether formal or informal), or enters into liquidation (whether voluntary or compulsory) except a solvent voluntary liquidation for the purpose only of reconstruction or amalgamation, or has a receiver and/or manager, administrator or administrative receiver appointed of its undertaking or any part thereof, or documents are filed with the court for the appointment of an administrator of the Buyer or notice of intention to appoint an administrator is given by the Buyer or its directors or by a qualifying floating charge holder (as defined in paragraph 14 of Schedule B1 to the Insolvency Act 1986), or a resolution is passed or a petition presented to any court for the winding-up of the Buyer or for the granting of an administration order in respect of the Buyer, or any proceedings are commenced relating to the insolvency or possible insolvency of the Buyer; or
- 5.4.2 the Buyer suffers or allows any execution, whether legal or equitable, to be levied on his/its property or obtained against him/it, or fails to observe or perform any of his/its obligations under the Contract or any other Contract between the Company and the Buyer, or is unable to pay its debts within the meaning of section 123 of the Insolvency Act 1986 or the Buyer ceases to trade; or
- 5.4.3 the Buyer encumbers or in any way changes any of the Goods.
- 5.5 The Company shall be entitled to recover payment for the Goods notwithstanding that ownership of any of the Goods has not passed from the Company.
- 5.6 The Buyer grants the Company, its agents and employees an irrevocable licence at any time to enter any premises where the Goods are or may be stored in order to inspect them, or, where the Buyer's right to possession has terminated, to recover them.
- 5.7 Where the Company is unable to determine whether any Goods are the Goods in respect of which the Buyer's right to possession has terminated, the Buyer shall be deemed to have sold all Goods of the kind sold by the Company to the Buyer in the order in which they were invoiced to the Buyer.
- 5.8 On termination of the Contract, howsoever caused, the Company's (but not the Buyer's) rights contained in this condition 5 shall remain in effect.
- 5.9 The Buyer is not the Company's agent and has not authority to make any Contract on the Company's behalf or in the Company's name.
- 6 Risk**
- 6.1 Delivery shall be FCA (Incoterms 2000) at the Company Warehouse and the Goods are at the Buyer's risk from the time of delivery.
- 6.2 The Buyer must inspect the Goods on delivery, which shall be at the Company Warehouse in accordance with Clause 6.1. If any Goods are damaged, the Buyer must write to tell the Company within seven working days of delivery. The Buyer must give the Company a reasonable opportunity to inspect the damaged Goods.
- 7 Warranties**
- 7.1 The Company warrants that the Goods:
- 7.1.1 be of satisfactory quality within the meaning of the Sale of Goods Act 1979;
- 7.1.2 comply with their description on the Company's delivery note; and
- 7.1.3 are free from material defect at the time of delivery (as long as the Buyer complies with clause 6.3).
- 7.2 The Company gives no other warranty (and excludes any warranty, term or condition that would otherwise be implied) as to the quality of the Goods or their fitness for any purpose.
- 7.3 If the Buyer believes that the Company has delivered Goods which are defective in material or workmanship, the Buyer must:
- 7.3.1 inform the Company (in writing), with full details, as soon as possible; and
- 7.3.2 allow the Company to investigate (the Company may need access to Buyer's premises and product samples).
- 7.4 if the Goods are found to be defective in material or workmanship (following the Company's investigations), and the Buyer has complied with those conditions (in clause 7.3) in full, the Company will (at its option) replace the Goods or refund the price.
- 7.5 The Company's entire liability and obligation, and the Buyer's exclusive remedy with respect to any breach of warranties under Clause 7.1, shall be limited to replacing the Goods in accordance with Clause 7.4. Except for such replacement obligation, the Company shall not be liable for any defect, damage or loss with respect to any of the Goods, even if the same is caused by the negligence or other fault of the Company. Nothing in this clause or in these terms shall limit the Company's liability for personal injury or death caused by its negligence.



Scie-Plas Ltd

22 Cambridge Science Park
Milton Road
Cambridge
CB4 0FJ
United Kingdom

T: +44 (0) 1223 427888

F: +44 (0) 1223 420164

e: sales@scie-plas.co.uk

www.scie-plas.com